



Ordering Catalogue





1982

Elabo launches one of the first safety test systems with electronic data transmission—micro instead of mainframe computers

1988

With its new InForm range, Elabo starts a revolution in technical workstations. Power supply as well as measuring and testing devices are arranged at eye level. Using patented connection equipment.

1980

Elabo launches their first in-house developed safety testing devices.

2003

Modular assembly workstation designs for TaMas product line.

2005

Elabo creates a sensation with its fully re-developed C# software bundle, making it possible for the first time to perfectly coordinate object-oriented software modules.

2009

Elabo's HighPerformance device series ushers in a new era of modular devices for safety testing equipment.

1996

Elabo implements fully networked testing and measuring units for electrical equipment quality assurance.

2010

elution introduces fully integrated testing and electronic measuring equipment into the world of Elabo's software.

2012

Elabo continues to revolutionise workstation systems. primus one is a true masterpiece!

2014

For the first time, Elabo showcases Smart Factory at the Munich trade fair to later install it at their Crailsheim headquarters.

2020

ELABO becomes a member of the Gustav Zech Foundation

2021

ELABO becomes a part of the Bott Group



Ordering Catalogue



Table of contents

A primus one	4
B primus basic	82
C Underbench cabinets	138
D Illumination	157
E Mobiles	171
F General accessories	197
G Electronics	213
H Accessories ESD	416
I Chairs	424
J Conference Tables	436
K Storage	440
L 19" Cabinets	466
M Education	473
N Storage shelves &	500

A primus one



Table of contents

A1 Tables	5	5
A1.1 Table accessories		19
A2 Corner panels		27
A3 Shelvelements		37
A4 Superstructures		47
A5 System profiles		61
A6 Insert panels		63
A7 Accessories Primus One®		79

Tables

A1

primus one

System table with cable flap and cable through



Edge strip



F-edging

Technical features

- Rear table legs as system profile column with integrated cable duct
- Heavy-load slot nuts on the table legs for attaching accessories
- Centrally arranged fold-away cable flap
- Large-volume cable through accessible from the front
- When set up side by side the cabling can be passed straight through
- Height adjusters for leveling on uneven floors
- Individual colour choice possible
- System profile can be expanded at the back
- Front table legs can be set back to provide more legroom
- ESD [Electrostatic Discharge] variant for EPA [Electrostatic Protective Area] facilities
- Loadable from 500 kg surface load

Note:

Profile insert panels must be ordered separately. You can find them in Chapter 1.1 Table accessories.

primus one

System table with cable flap and cable through

Technical data

Table top	
Thickness	30 mm
Front edge	Edge strip 3 mm thick or Flexi-Line edging, exchangeable (F- edging)
Coating	HPL laminate 0.8 mm, non-glare, abrasion-resistant in accordance with EN 438, heat-resistant for short periods, highly flame-retardant
Colour	light grey RAL 7035
Cable duct	
Dimension	Height = 150 mm, Depth = 175 mm
Cable flap	
Configuration	Fold-away, with brush strip on the back
Dimension	Width = 880 mm, Depth = 124 mm, Height = 30 mm
Load capacity	
Weight loading	500 kg Surface load capacity
ESD variant	
Table top	Same properties as standard model but volume-conductive
Configuration	DIN EN 61340-5-1 Part 5-1
Dimension	
Width	1200 mm, 1500 mm, 1600 mm, 1800 mm, 2000 mm
Depth	800 mm, 900 mm, 1000 mm
Height	750 mm

Ordering no.

Width x Depth	F-edging	F-edging ESD 	Edge strip	Edge strip ESD 
1200 mm x 800 mm	K0-1E	K0-4E	K0-1E.S	K0-4E.S
1500 mm x 800 mm	K0-1D	K0-4D	K0-1D.S	K0-4D.S
1600 mm x 800 mm	K0-1C	K0-4C	K0-1C.S	K0-4C.S
1800 mm x 800 mm	K0-1B	K0-4B	K0-1B.S	K0-4B.S
2000 mm x 800 mm	K0-1A	K0-4A	K0-1A.S	K0-4A.S
1200 mm x 900 mm	K0-2E	K0-5E	K0-2E.S	K0-5E.S
1500 mm x 900 mm	K0-2D	K0-5D	K0-2D.S	K0-5D.S
1600 mm x 900 mm	K0-2C	K0-5C	K0-2C.S	K0-5C.S
1800 mm x 900 mm	K0-2B	K0-5B	K0-2B.S	K0-5B.S
2000 mm x 900 mm	K0-2A	K0-5A	K0-2A.S	K0-5A.S
1200 mm x 1000 mm	K0-3E	K0-6E	K0-3E.S	K0-6E.S
1500 mm x 1000 mm	K0-3D	K0-6D	K0-3D.S	K0-6D.S
1600 mm x 1000 mm	K0-3C	K0-6C	K0-3C.S	K0-6C.S
1800 mm x 1000 mm	K0-3B	K0-6B	K0-3B.S	K0-6B.S
2000 mm x 1000 mm	K0-3A	K0-6A	K0-3A.S	K0-6A.S

primus one

System table height-adjustable by electric motor



Edge strip



F-edging

Technical features

- Centrally arranged fold-away cable flap
- Large-volume cable through accessible from the front
- When set up side by side the cabling can be passed straight through
- Exchangeable front edge (in configuration with F-edging)
- Height adjusters for leveling on uneven floors
- Electrohydraulic height adjustment
- Programmable minimum and maximum height
- ESD [Electrostatic Discharge] variant for EPA [Electrostatic Protective Area] facilities
- Lift capacity 1600 N per column
- Travel speed 15 mm / s
- Shortening of the table legs for corner installation is possible.

Note:

Find the suitable accessories on page 96

primus one

System table height-adjustable by electric motor

Technical data

Table top	
Thickness	30 mm
Front edge	Edge strip 3 mm thick or Flexi-Line edging, exchangeable (F- edging)
Coating	HPL laminate 0.8 mm, non-glare, abrasion-resistant in accordance with EN 438, heat-resistant for short periods, highly flame-retardant
Colour	light grey RAL 7035
Cable duct	
Dimension	Height = 150 mm, Depth = 175 mm
Cable flap	
Configuration	Fold-away, with brush strip on the back
Dimension	Width = 880 mm, Depth = 124 mm, Height = 30 mm
Load capacity	
Weight loading	200 kg Surface load capacity
ESD variant	
Table top	Same properties as standard model but volume-conductive
Configuration	DIN EN 61340-5-1 Part 5-1
Dimension	
Width	1200 mm, 1500 mm, 1600 mm, 1800 mm, 2000 mm
Depth	800 mm, 900 mm, 1000 mm
Height	from 750...1200 mm

Ordering no.

Width x Depth	F-edging	F-edging ESD 	Edge strip	Edge strip ESD 
1200 mm x 800 mm	K0-1E.EC	K0-4E.EC	K0-1E.SEC	K0-4E.SEC
1500 mm x 800 mm	K0-1D.EC	K0-4D.EC	K0-1D.SEC	K0-4D.SEC
1600 mm x 800 mm	K0-1C.EC	K0-4C.EC	K0-1C.SEC	K0-4C.SEC
1800 mm x 800 mm	K0-1B.EC	K0-4B.EC	K0-1B.SEC	K0-4B.SEC
2000 mm x 800 mm	K0-1A.EC	K0-4A.EC	K0-1A.SEC	K0-4A.SEC
1200 mm x 900 mm	K0-2E.EC	K0-5E.EC	K0-2E.SEC	K0-5E.SEC
1500 mm x 900 mm	K0-2D.EC	K0-5D.EC	K0-2D.SEC	K0-5D.SEC
1600 mm x 900 mm	K0-2C.EC	K0-5C.EC	K0-2C.SEC	K0-5C.SEC
1800 mm x 900 mm	K0-2B.EC	K0-5B.EC	K0-2B.SEC	K0-5B.SEC
2000 mm x 900 mm	K0-2A.EC	K0-5A.EC	K0-2A.SEC	K0-5A.SEC
1200 mm x 1000 mm	K0-3E.EC	K0-6E.EC	K0-3E.SEC	K0-6E.SEC
1500 mm x 1000 mm	K0-3D.EC	K0-6D.EC	K0-3D.SEC	K0-6D.SEC
1600 mm x 1000 mm	K0-3C.EC	K0-6C.EC	K0-3C.SEC	K0-6C.SEC
1800 mm x 1000 mm	K0-3B.EC	K0-6B.EC	K0-3B.SEC	K0-6B.SEC
2000 mm x 1000 mm	K0-3A.EC	K0-6A.EC	K0-3A.SEC	K0-6A.SEC

primus one

System table with cable duct



Edge strip



F-edging

Technical features

- Rear table legs as system profile column with integrated cable duct
- Exchangeable front edge
- Heavy-load slot nuts on the table legs for attaching accessories
- Large-volume cable through accessible from the front
- When set up side by side the cabling can be passed straight through
- Height adjusters for leveling on uneven floors
- Individual colour choice possible
- System profile can be expanded at the back
- Front table legs can be set back to provide more legroom
- ESD [Electrostatic Discharge] variant for EPA [Electrostatic Protective Area] facilities

Note:

Profile insert panels must be ordered separately. You can find them in Chapter 1.1 Table accessories.



primus one

System table with cable duct

Technical data

Table top	
Thickness	30 mm
Front edge	Edge strip 3 mm thick or Flexi-Line edging, exchangeable (F- edging)
Coating	HPL laminate 0.8 mm, non-glare, abrasion-resistant in accordance with EN 438, heat-resistant for short periods, highly flame-retardant
Colour	light grey RAL 7035
Cable duct	
Dimension	Height = 150 mm, Depth = 175 mm
Load capacity	
Weight loading	200 kg Surface load capacity
ESD variant	
Table top	Same properties as standard model but volume-conductive
Configuration	DIN EN 61340-5-1 Part 5-1
Dimension	
Width	1200 mm, 1500 mm, 1600 mm, 1800 mm, 2000 mm
Depth	800 mm 900 mm 1000 mm
Height	750 mm

Ordering no.

Width x Depth	F-edging	F-edging ESD 	Edge strip	Edge strip ESD 
1200 mm x 800 mm	K0-1E.2	K0-4E.2	K0-1E.S2	K0-4E.S2
1500 mm x 800 mm	K0-1D.2	K0-4D.2	K0-1D.S2	K0-4D.S2
1600 mm x 800 mm	K0-1C.2	K0-4C.2	K0-1C.S2	K0-4C.S2
1800 mm x 800 mm	K0-1B.2	K0-4B.2	K0-1B.S2	K0-4B.S2
2000 mm x 800 mm	K0-1A.2	K0-4A.2	K0-1A.S2	K0-4A.S2
1200 mm x 900 mm	K0-2E.2	K0-5E.2	K0-2E.S2	K0-5E.S2
1500 mm x 900 mm	K0-2D.2	K0-5D.2	K0-2D.S2	K0-5D.S2
1600 mm x 900 mm	K0-2C.2	K0-5C.2	K0-2C.S2	K0-5C.S2
1800 mm x 900 mm	K0-2B.2	K0-5B.2	K0-2B.S2	K0-5B.S2
2000 mm x 900 mm	K0-2A.2	K0-5A.2	K0-2A.S2	K0-5A.S2
1200 mm x 1000 mm	K0-3E.2	K0-6E.2	K0-3E.S2	K0-6E.S2
1500 mm x 1000 mm	K0-3D.2	K0-6D.2	K0-3D.S2	K0-6D.S2
1600 mm x 1000 mm	K0-3C.2	K0-6C.2	K0-3C.S2	K0-6C.S2
1800 mm x 1000 mm	K0-3B.2	K0-6B.2	K0-3B.S2	K0-6B.S2
2000 mm x 1000 mm	K0-3A.2	K0-6A.2	K0-3A.S2	K0-6A.S2

primus one

System table without cable flap and cable duct



Edge strip



F-edging

Technical features

- Rear table legs as system profile column with integrated cable duct
- Heavy-load slot nuts on the table legs for attaching accessories
- Height adjusters for leveling on uneven floors
- Exchangeable front edge
- Individual colour choice possible
- System profile can be expanded at the back
- Front table legs can be set back to provide more legroom
- ESD [Electrostatic Discharge] variant for EPA [Electrostatic Protective Area] facilities
- Weight loading 500 kg Surface load capacity

Note:

Profile insert panels must be ordered separately. You can find them in Chapter 1.1 Table accessories.

Caution: Additional balance panel with a height of 150 mm are needed for the missing cable through.

primus one

System table without cable flap and cable duct

Technical data

Table top	
Thickness	30 mm
Front edge	Edge strip 3 mm thick or Flexi-Line edging, exchangeable (F- edging)
Coating	HPL laminate 0.8 mm, non-glare, abrasion-resistant in accordance with EN 438, heat-resistant for short periods, highly flame-retardant
Colour	light grey RAL 7035
Load capacity	
Weight loading	500 kg Surface load capacity
ESD variant	
Table top	Same properties as standard model but volume-conductive
Configuration	DIN EN 61340-5-1 Part 5-1
Dimension	
Width	1200 mm, 1500 mm, 1600 mm, 1800 mm, 2000 mm
Depth	800 mm, 900 mm, 1000 mm
Height	750 mm

Ordering no.

Width x Depth	F-edging	F-edging ESD 	Edge strip	Edge strip ESD 
1200 mm x 800 mm	K0-1E.1	K0-4E.1	K0-1E.S1	K0-4E.S1
1500 mm x 800 mm	K0-1D.1	K0-4D.1	K0-1D.S1	K0-4D.S1
1600 mm x 800 mm	K0-1C.1	K0-4C.1	K0-1C.S1	K0-4C.S1
1800 mm x 800 mm	K0-1B.1	K0-4B.1	K0-1B.S1	K0-4B.S1
2000 mm x 800 mm	K0-1A.1	K0-4A.1	K0-1A.S1	K0-4A.S1
1200 mm x 900 mm	K0-2E.1	K0-5E.1	K0-2E.S1	K0-5E.S1
1500 mm x 900 mm	K0-2D.1	K0-5D.1	K0-2D.S1	K0-5D.S1
1600 mm x 900 mm	K0-2C.1	K0-5C.1	K0-2C.S1	K0-5C.S1
1800 mm x 900 mm	K0-2B.1	K0-5B.1	K0-2B.S1	K0-5B.S1
2000 mm x 900 mm	K0-2A.1	K0-5A.1	K0-2A.S1	K0-5A.S1
1200 mm x 1000 mm	K0-3E.1	K0-6E.1	K0-3E.S1	K0-6E.S1
1500 mm x 1000 mm	K0-3D.1	K0-6D.1	K0-3D.S1	K0-6D.S1
1600 mm x 1000 mm	K0-3C.1	K0-6C.1	K0-3C.S1	K0-6C.S1
1800 mm x 1000 mm	K0-3B.1	K0-6B.1	K0-3B.S1	K0-6B.S1
2000 mm x 1000 mm	K0-3A.1	K0-6A.1	K0-3A.S1	K0-6A.S1

primus one

System table with cable flap and cable duct, mobile



Edge strip



F-edging

Technical features

- Rear table legs as system profile column with integrated cable duct
- 4 double swivel castors 100 mm diameter, 2 of them lockable
- Load-bearing capacity 100 kg per castor
- Exchangeable front edge
- Heavy-load slot nuts on the table legs for attaching accessories
- Centrally arranged fold-away cable flap
- Large-volume cable through accessible from the front
- Individual colour choice possible
- System profile can be expanded at the back
- ESD [Electrostatic Discharge] variant for EPA [Electrostatic Protective Area] facilities

Note:

Profile insert panels must be ordered separately. You can find them in Chapter 1.1 Table accessories.

Caution: Balance panel with height of 413 mm are needed

Traverse K9-0J.B.. for reinforcement available on request

primus one

System table with cable flap and cable duct, mobile

Technical data

Table top	
Thickness	30 mm
Front edge	Edge strip 3 mm thick or Flexi-Line edging, exchangeable (F- edging)
Coating	HPL laminate 0.8 mm, non-glare, abrasion-resistant in accordance with EN 438, heat-resistant for short periods, highly flame-retardant
Colour	light grey RAL 7035
Cable duct	
Dimension	Height = 150 mm, Depth = 175 mm
Cable flap	
Configuration	Fold-away, with brush strip on the back
Dimension	Width = 880 mm, Depth = 124 mm, Height = 30 mm
Load capacity	
Weight loading	200 kg Surface load capacity
ESD variant	
Table top	Same properties as standard model but volume-conductive
Configuration	DIN EN 61340-5-1 Part 5-1
Dimension	
Width	1200 mm, 1500 mm, 1600 mm, 1800 mm, 2000 mm
Depth	800 mm, 900 mm, 1000 mm
Height	750 mm
Castor diameter	100 mm

Ordering no.

Width x Depth	F-edging	F-edging ESD 	Edge strip	Edge strip ESD 
1200 mm x 800 mm	K0-1E.R	K0-4E.R	K0-1E.RS	K0-4E.RS
1500 mm x 800 mm	K0-1D.R	K0-4D.R	K0-1D.RS	K0-4D.RS
1600 mm x 800 mm	K0-1C.R	K0-4C.R	K0-1C.RS	K0-4C.RS
1800 mm x 800 mm	K0-1B.R	K0-4B.R	K0-1B.RS	K0-4B.RS
2000 mm x 800 mm	K0-1A.R	K0-4A.R	K0-1A.RS	K0-4A.RS
1200 mm x 900 mm	K0-2E.R	K0-5E.R	K0-2E.RS	K0-5E.RS
1500 mm x 900 mm	K0-2D.R	K0-5D.R	K0-2D.RS	K0-5D.RS
1600 mm x 900 mm	K0-2C.R	K0-5C.R	K0-2C.RS	K0-5C.RS
1800 mm x 900 mm	K0-2B.R	K0-5B.R	K0-2B.RS	K0-5B.RS
2000 mm x 900 mm	K0-2A.R	K0-5A.R	K0-2A.RS	K0-5A.RS
1200 mm x 1000 mm	K0-3E.R	K0-6E.R	K0-3E.RS	K0-6E.RS
1500 mm x 1000 mm	K0-3D.R	K0-6D.R	K0-3D.RS	K0-6D.RS
1600 mm x 1000 mm	K0-3C.R	K0-6C.R	K0-3C.RS	K0-6C.RS
1800 mm x 1000 mm	K0-3B.R	K0-6B.R	K0-3B.RS	K0-6B.RS
2000 mm x 1000 mm	K0-3A.R	K0-6A.R	K0-3A.RS	K0-6A.RS

primus one

System table with 30 mm Multiplex top



Without edge strip



F-edging

Technical features

- 30 mm study multiplex top
- Height adjusters for leveling on uneven floors
- Centrally arranged fold-away cable flap
- Large-volume cable through accessible from the front

Note:

Compatible in row and block formation with Primus One System

Profile insert panels must be ordered separately. You can find them in Chapter 1.1 Table accessories.

primus one

System table with 30 mm Multiplex top

Technical data

Table top	
Thickness	30 mm
Front edging	without Edge strip or Flexi-Line edging, exchangeable (F-edging)
Colour	multiplex decor
Load capacity	
Weight loading	200 kg surface load capacity
Dimension	
Width	1200 mm, 1500 mm, 1600 mm, 1800 mm, 2000 mm
Depth	800 mm, 900 mm, 1000 mm
Height	750 mm

Cabel duct

Dimension	
Depth	175 mm
Height	150 mm

Cabel flap

Configuration Fold-away, with brush strips on the back	
Dimension	
Depth	124 mm
Height	30 mm
Width	880 mm

Ordering no.

Width x Depth	F-edging	Without edge strip
1200 mm x 800 mm	K0-1E.MU	K0-1E.SMU
1500 mm x 800 mm	K0-1D.MU	K0-1D.SMU
1600 mm x 800 mm	K0-1C.MU	K0-1C.SMU
1800 mm x 800 mm	K0-1B.MU	K0-1B.SMU
2000 mm x 800 mm	K0-1A.MU	K0-1A.SMU
1200 mm x 900 mm	K0-2E.MU	K0-2E.SMU
1500 mm x 900 mm	K0-2D.MU	K0-2D.SMU
1600 mm x 900 mm	K0-2C.MU	K0-2C.SMU
1800 mm x 900 mm	K0-2B.MU	K0-2B.SMU
2000 mm x 900 mm	K0-2A.MU	K0-2A.SMU
1200 mm x 1000 mm	K0-3E.MU	K0-3E.SMU
1500 mm x 1000 mm	K0-3D.MU	K0-3D.SMU
1600 mm x 1000 mm	K0-3C.MU	K0-3C.SMU
1800 mm x 1000 mm	K0-3B.MU	K0-3B.SMU
2000 mm x 1000 mm	K0-3A.MU	K0-3A.SMU

A primus one

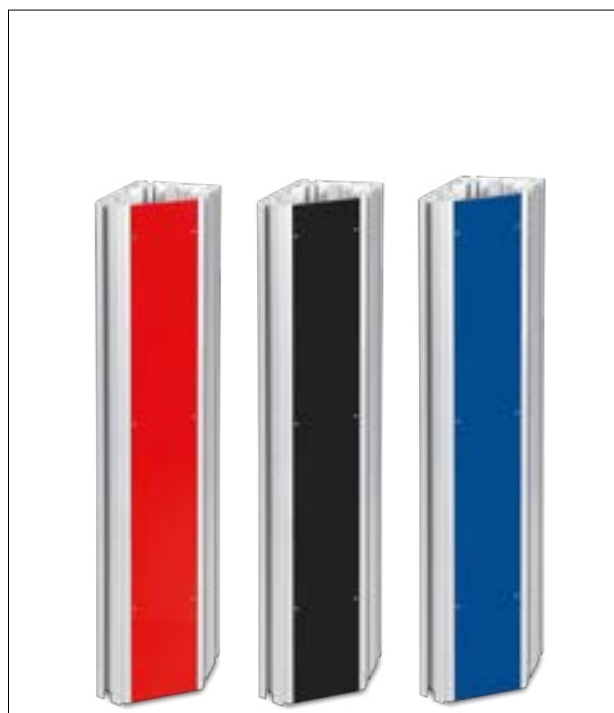

Table accessories

A1.1

primus one

Table accessories



Technical features

- Intelligent additions to your table
- System profile insert panel for providing power in the rear table legs
- Electric socket installation kits for the cable through
- Spare parts and upgrades guarantee long-term unrestricted use of the tables
- Accessories adapt the table to new requirements
- Comprehensive detailed solutions

Standard colours:



Traffic red	RAL3020
Signal blue	RAL5005
Black grey	RAL7021

Individual colour available on request.

primus one

System profile insert panel for rear table legs



Technical data

Description			Ordering no.
<p>Blank panel for closing of the rear profile</p> <p>W = 80 mm, H = 523 mm</p> <p>Blank panel (for mobile tables) for closing of the rear profile</p> <p>W = 80 mm, H = 413 mm</p>		<p>Insert panel traffic red</p> <p>Insert panel signal blue</p> <p>Insert panel black grey</p> <p>Insert panel traffic red</p> <p>Insert panel signal blue</p> <p>Insert panel black grey</p>	<p>K5-0L0000.523.3020</p> <p>K5-0L0000.523.5005</p> <p>K5-0L0000.523.7021</p> <p>K5-0L0000.413.3020</p> <p>K5-0L0000.413.5005</p> <p>K5-0L0000.413.7021</p>
<p>Balance panel are necessary for tables without cable duct</p> <p>W =80 mm, H = 150 mm</p>		<p>Insert panel traffic red</p> <p>Insert panel signal blue</p> <p>Insert panel black grey</p>	<p>K5-0L0000.150.3020</p> <p>K5-0L0000.150.5005</p> <p>K5-0L0000.150.7021</p>
<p>Profile panel with cable outlet</p> <p>W =80 mm, H = 523 mm</p> <p>Equipment: cable outlet black Ø 60 mm</p>		<p>Insert panel traffic red</p> <p>Insert panel signal blue</p> <p>Insert panel black grey</p>	<p>K5-0L0100.523.3020</p> <p>K5-0L0100.523.5005</p> <p>K5-0L0100.523.7021</p>

primus one

System profile insert panel for rear table legs



Technical data

Description			Ordering no.
<p>PC connecting panel 1/N/PE ~ 50 Hz 230 V 16 A at Schuko socket (type F) with network connection and cable outlet Ø 60 mm</p> <p>W = 80 mm, H = 523 mm</p> <p>Equipment: 1 Schuko socket (type F) 1 RJ-45 Cat6 receptacle/receptacle 1 cable outlet black Ø 60 mm</p> <p>Country-specific variants possible for safety sockets.</p>		<p>Insert panel traffic red</p> <p>Insert panel signal blue</p> <p>Insert panel black grey</p>	<p>K5-2H00DE.523.3020</p> <p>K5-2H00DE.523.5005</p> <p>K5-2H00DE.523.7021</p>
<p>Power supply panel 1/N/PE ~50 Hz 230 V 16 A at Schuko socket (type F) with network connection and cable outlet Ø 60 mm and cut-out for surface-mounted socket box.</p> <p>W = 80 mm, H = 523 mm</p> <p>Equipment: 1 Schuko socket (type F) 1 cable outlet black Ø 60 mm 1 cut-out for flush-mounted systems</p> <p>Country-specific variants possible for safety sockets.</p>		<p>Insert panel traffic red</p> <p>Insert panel signal blue</p> <p>Insert panel black grey</p>	<p>K5-2H01DE.523.3020</p> <p>K5-2H01DE.523.5005</p> <p>K5-2H01DE.523.7021</p>
<p>Power supply panel 1/N/PE ~50 Hz 230 V 16 A at Schuko socket (type F) with network connection and cable outlet Ø 60 mm and cut-out for surface-mounted socket box.</p> <p>W = 80 mm, H = 523 mm</p> <p>Equipment: 1 Schuko socket (type F) 1 cable outlet black Ø 60 mm 2 cut-outs for flush-mounted systems</p> <p>Country-specific variants possible for safety sockets.</p>		<p>Insert panel traffic red</p> <p>Insert panel signal blue</p> <p>Insert panel black grey</p>	<p>K5-2H02DE.523.3020</p> <p>K5-2H02DE.523.5005</p> <p>K5-2H02DE.523.7021</p>

primus one

System profile insert panel for rear table legs



Technical data

Description			Ordering no.
<p>Power supply panel 1 / N / PE ~ 50 Hz 230 V 16 A at Schuko socket (type F) with cable outlet Ø 60 mm</p> <p>W =80 mm, H = 523 mm</p> <p>Equipment: 1 Schuko socket (type F) 2 cable outlets black Ø 60 mm</p> <p>Country-specific variants possible for safety sockets.</p>		<p>Insert panel traffic red</p> <p>Insert panel signal blue</p> <p>Insert panel black grey</p>	<p>K5-2A00DE.523.3020</p> <p>K5-2A00DE.523.5005</p> <p>K5-2A00DE.523.7021</p>
<p>Power supply panel 1 / N / PE ~ 50 Hz 230 V 16 A</p> <p>at Schuko socket (type F) with cable outlet Ø 60 mm</p> <p>W =80 mm, H = 523 mm</p> <p>Equipment: 1 Schuko socket (type F) 2 cable outlets black Ø 60 mm</p>		<p>Insert panel traffic red</p> <p>Insert panel signal blue</p> <p>Insert panel black grey</p>	<p>K5-2A01DE.523.3020</p> <p>K5-2A01DE.523.5005</p> <p>K5-2A01DE.523.7021</p>
<p>Power supply panel 1 / N / PE ~ 50 Hz 230 V 16 A</p> <p>at Schuko sockets (type F)</p> <p>W =80 mm, H = 523 mm</p> <p>Equipment: 1 illuminated rocker switch 5 Schuko socket (type F)</p> <p>Country-specific variants possible for safety sockets.</p>		<p>Insert panel traffic red</p> <p>Insert panel signal blue</p> <p>Insert panel black grey</p>	<p>K5-2A02DE.523.3020</p> <p>K5-2A02DE.523.5005</p> <p>K5-2A02DE.523.7021</p>

primus one

System profile insert panel for rear table legs



Technical data

Description			Ordering no.
<p>Power supply panel 1 / N / PE ~ 50 Hz 230 V 16 A</p> <p>at Schuko socket (type F) with cable outlet Ø 60 mm</p> <p>W =80 mm, H = 523 mm</p> <p>Equipment: 1 cable outlet black Ø 60 mm 1 illuminated rocker switch 4 Schuko socket (type F)</p> <p>Country-specific variants possible for safety sockets.</p>		<p>Insert panel traffic red</p> <p>Insert panel signal blue</p> <p>Insert panel black grey</p>	<p>K5-2D01DE.523.3020</p> <p>K5-2D01DE.523.5005</p> <p>K5-2D01DE.523.7021</p>
<p>Power supply panel 3 / N / PE ~ 50 Hz 400 V 16 A</p> <p>at CEE socket outlet and Schuko socket (type F), as well as cable outlet Ø 60 mm</p> <p>W =80 mm, H = 523 mm</p> <p>Equipment: 1 cable outlet black Ø 60 mm 1 CEE socket outlet 2 Schuko socket (type F)</p>		<p>Insert panel traffic red</p> <p>Insert panel signal blue</p> <p>Insert panel black grey</p>	<p>K5-3A01DE.523.3020</p> <p>K5-3A01DE.523.5005</p> <p>K5-3A01DE.523.7021</p>
<p>Power supply panel 3 / N / PE ~ 50 Hz 400 V 16 A</p> <p>at CEE socket outlet and cable outlet Ø 60 mm</p> <p>W =80 mm, H = 523 mm</p> <p>Equipment: 1 cable outlet black Ø 60 mm 1 CEE socket outlet</p>		<p>Insert panel traffic red</p> <p>Insert panel signal blue</p> <p>Insert panel black grey</p>	<p>K5-3A02DE.523.3020</p> <p>K5-3A02DE.523.5005</p> <p>K5-3A02DE.523.7021</p>

primus one

Table accessories

Technical data

Description		Ordering no.	
Socket set consisting of 2 socket brackets for the cable duct 2 socket strips, each with 3 safety sockets 1 safety socket connecting cable 3 m 1 connecting cable 0.5 m		81-2X Z01	
Replacement table edging for table tops with Flexi-Line edging		for table width 1200 mm 1500 mm 1600 mm 1800 mm 2000 mm	81-6K ZB1200 81-6K ZB1500 81-6K ZB1600 81-6K ZB1800 81-6K ZB2000
Primus One closure panel for covering the side of the stan- dard cable duct. Made from sheet steel, powder coated, light grey. Cover table top made of wood Including assembly material. for electric height adjustable tables		K9-0A K9-0A.EC	
Primus One bridging duct for connecting two Primus One cable ducts when the tables are arranged side by side. Made from sheet steel, powder coated, light grey. Cover table top made of wood Including assembly material.		K9-0B	

primus one

Table accessories

Technical data

Description			Ordering no.
<p>Table leg adapter for lengthening the table legs by 30, 50, 60, 100 mm</p> <p>Other height possible on request.</p> <p>Note: Balance panels in same height are necessary! See chapter 1.1</p>		<p>K9-0X H030</p> <p>K9-0X H050</p> <p>K9-0X H060</p> <p>K9-0X H100</p>	
<p>Snap-on nuts for attaching accessories</p> <p>Set consists of 5 nuts with accessories</p>		<p>for M5</p> <p>for M6</p> <p>for M8</p>	<p>78-2HZM5</p> <p>78-2H</p> <p>78-2J</p>
<p>Table foot bracket</p> <p>Supplied in pairs including mounting material</p>			<p>K9-0G</p> 
<p>Connecting bracket</p> <p>Supplied in pairs including mounting material</p>			<p>K9-0H</p> 
<p>Filler piece for mounting on the system profile, made from sheet steel, powder-coated, including mounting material Content of package = 1 piece</p>			<p>K9-0D</p> 
<p>4 double swivel castors two of which are lockable for retrofitting</p> <p>Load-bearing capacity 100 kg per castor diameter 100 mm Construction height 120 mm</p>			<p>78-1R</p> <p>78-1S</p> 



Corner panels

A2

System-Corner table top

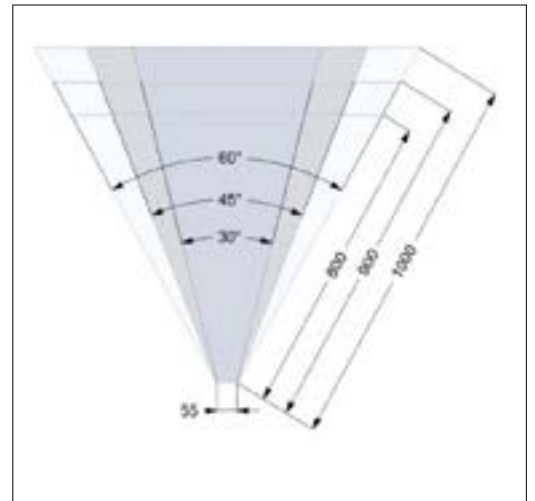
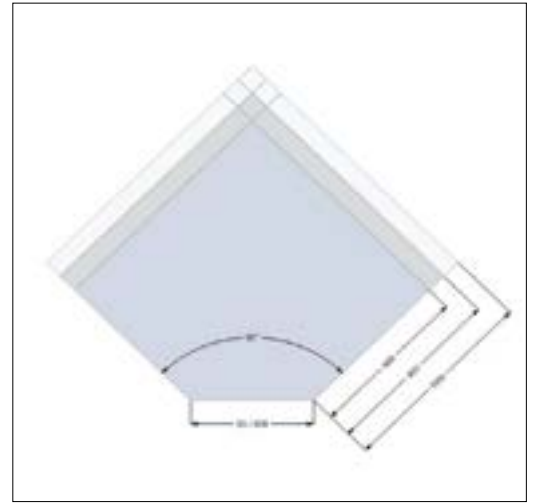
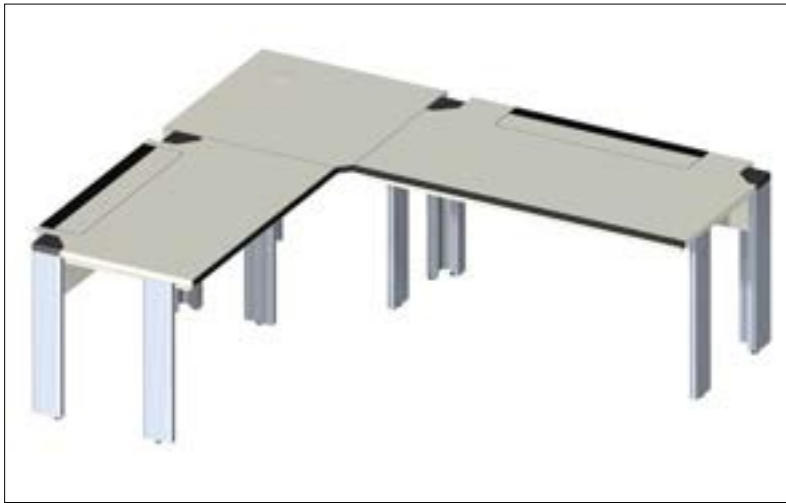

Technical features

- Corner sections suitable for corner combinations with system tables without the need for legs
- Asymmetrical variants are available for connecting system tables of different depths
- 90° corner sections are generally fitted with an extra supporting leg to increase stability
- Wire mesh cable tray permits simple cable routing
- Optionally available with cover panels to optically match the sections to the system tables
- ESD [Electrostatic Discharge] variant for EPA [Electrostatic Protective Area] facilities

Note:

Including wire mesh tray for routing cables

Including supporting foot

Including cable outlet Ø 80 mm light grey

Corner sections suitable also for Primus Basic

System-Corner table top





Technical data

Table top	
Thickness	30 mm
Front edge	Edge strip 3 mm thick or Flexi-Line edging, exchangeable (F- edging)
Coating	HPL laminate 0.8 mm, non-glare, abrasion-resistant in accordance with EN 438, heat-resistant for short periods
Colour	light grey RAL 7035
Support leg for 90° edges	
Dimension	Height = 750 mm
Wire mesh cable tray	
Dimension	Width = 100 mm, Height = 35 mm
Load capacity	
Weight loading	80 kg Surface load capacity
ESD variant	
Table top	Same properties as standard model but volume-conductive
Configuration	DIN EN 61340-5-1 Part 5-1
Dimension	
Seat side	55 / 600 mm
Depth	800 mm, 900 mm, 1000 mm
Angle	30°, 45°, 90°
Height	750 mm
Cable outlet	80 mm

Description		Width x Depth	Standard	ESD 
Corner table top 90° including supporting foot Seat side 55 mm Note: Outer side length + 40 mm at each side Can be used for the Systems Primus One and Primus Basic		F-edging 800 mm x 800 mm 900 mm x 900 mm 1000 mm x 1000 mm Edge strip 800 mm x 800 mm 900 mm x 900 mm 1000 mm x 1000 mm	K1-1A K1-1B K1-1C K1-1A.S K1-1B.S K1-1C.S	K1-3A K1-3B K1-3C K1-3A.S K1-3B.S K1-3C.S
CAD-corner table top 90° including supporting foot Seat side 600 mm Note: Outer side length + 424 mm at each side Can be used for the Systems Primus One and Primus Basic		F-edging 800 mm x 800 mm 900 mm x 900 mm 1000 mm x 1000 mm Edge strip 800 mm x 800 mm 900 mm x 900 mm 1000 mm x 1000 mm	K1-2A K1-2B K1-2C K1-2A.S K1-2B.S K1-2C.S	K1-4A K1-4B K1-4C K1-4A.S K1-4B.S K1-4C.S

System-Corner table top

Technical data

Description		Width x Depth	Standard	ESD 
<p>Corner table top 90° including supporting foot</p> <p>Seat side 55 mm</p> <p>Note: Outer side length + 40 mm at each side</p> <p>Can be used for the Systems Primus One and Primus Basic</p>		<p>F-edging 800 mm x 900 mm 800 mm x 1000 mm 900 mm x 1000 mm</p> <p>Edge strip 800 mm x 900 mm 800 mm x 1000 mm 900 mm x 1000 mm</p>	<p>K1-1D K1-1E K1-1F</p> <p>K1-1D.S K1-1E.S K1-1F.S</p>	<p>K1-3D K1-3E K1-3F</p> <p>K1-3D.S K1-3E.S K1-3F.S</p>
<p>Corner table top 90° including supporting foot</p> <p>Seat side 55 mm</p> <p>Note: Outer side length + 40 mm at each side</p> <p>Can be used for the Systems Primus One and Primus Basic</p>		<p>F-edging 900 mm x 800 mm 1000 mm x 900 mm 1000 mm x 800 mm</p> <p>Edge strip 900 mm x 800 mm 1000 mm x 900 mm 1000 mm x 800 mm</p>	<p>K1-1G K1-1H K1-1J</p> <p>K1-1G.S K1-1H.S K1-1J.S</p>	<p>K1-3G K1-3H K1-3J</p> <p>K1-3G.S K1-3H.S K1-3J.S</p>
<p>CAD- Corner table top 90° including supporting foot</p> <p>Seat side 600 mm</p> <p>Note: Outer side length + 424 mm at each side</p> <p>Can be used for the Systems Primus One and Primus Basic</p>		<p>F-edging 800 mm x 900 mm 800 mm x 1000 mm 900 mm x 1000 mm</p> <p>Edge strip 800 mm x 900 mm 800 mm x 1000 mm 900 mm x 1000 mm</p>	<p>K1-2D K1-2E K1-2F</p> <p>K1-2D.S K1-2E.S K1-2F.S</p>	<p>K1-4D K1-4E K1-4F</p> <p>K1-4D.S K1-4E.S K1-4F.S</p>
<p>CAD-corner table top 90° including supporting foot</p> <p>Seat side 600 mm</p> <p>Note: Outer side length + 424 mm at each side</p> <p>Can be used for the Systems Primus One and Primus Basic</p>		<p>F-edging 900 mm x 800 mm 1000 mm x 900 mm 1000 mm x 800 mm</p> <p>Edge strip 900 mm x 800 mm 1000 mm x 900 mm 1000 mm x 800 mm</p>	<p>K1-2G K1-2H K1-2J</p> <p>K1-2G.S K1-2H.S K1-2J.S</p>	<p>K1-4G K1-4H K1-4J</p> <p>K1-4G.S K1-4H.S K1-4J.S</p>

System-Corner table top

Technical data

Description		Width x Depth	Standard	ESD 
<p>Corner table top 45°</p> <p>Seat side 55 mm</p> <p>Can be used for the Systems Primus One and Primus Basic</p>		<p>F-edging 800 mm x 800 mm 900 mm x 900 mm 1000 mm x 1000 mm</p> <p>Edge strip 800 mm x 800 mm 900 mm x 900 mm 1000 mm x 1000 mm</p>	<p>K1-1A.45° K1-1B.45° K1-1C.45°</p> <p>K1-1A.S45° K1-1B.S45° K1-1C.S45°</p>	<p>K1-3A.45° K1-3B.45° K1-3C.45°</p> <p>K1-3A.S45° K1-3B.S45° K1-3C.S45°</p>
<p>Corner table top 30°</p> <p>Seat side 55 mm</p> <p>Can be used for the Systems Primus One and Primus Basic</p>		<p>F-edging 800 mm x 800 mm 900 mm x 900 mm 1000 mm x 1000 mm</p> <p>Edge strip 800 mm x 800 mm 900 mm x 900 mm 1000 mm x 1000 mm</p>	<p>K1-1A.30° K1-1B.30° K1-1C.30°</p> <p>K1-1A.S30° K1-1B.S30° K1-1C.S30°</p>	<p>K1-3A.30° K1-3B.30° K1-3C.30°</p> <p>K1-3A.S30° K1-3B.S30° K1-3C.S30°</p>
<p>Side table top</p> <p>Can be used for the Systems Primus One and Primus Basic</p>		<p>800 mm x 800 mm 800 mm x 900 mm 800 mm x 1000 mm</p>	<p>K0-7J.B0800T0800 K0-7J.B0800T0900 K0-7J.B0800T1000</p>	<p>K0-8J.B0800T0800 K0-8J.B0800T0900 K0-8J.B0800T1000</p>
<p>Table leg (1 Piece) for corner elements or add-on tables</p> <p>Can be used for the Systems Primus One and Primus Basic</p>		H = 720 mm	K9-1A	

primus one

System-Corner function shelf



Technical features

- Slide-prevention edging at the front and the back
- Stepless height adjustment
- ESD [Electrostatic Discharge] variant for EPA [Electrostatic Protective Area] facilities
- Two heavy-duty grooves are provided, one at the top and one at the bottom

primus one

System-Corner function shelf

Technical data

Shelf panel	
Thickness	19 mm
Coating	Melamine coating, resistant to organic solvents, weak acids, gasoline and oil
Colour	light grey RAL 7035
Load capacity	
Weight loading	60 kg Surface load capacity
ESD variant	
Table top	Same properties as standard model but volume-conductive
Configuration	DIN EN 61340-5-1 Part 5-1
Dimension	
Width function shelf	55 mm, 600 mm
Depth	400 mm
Height	88 mm

Ordering no.

Width / for table width	Standard	ESD 
800 mm / 55 mm	K4-3N.E	K4-3N.E_ESD
900 mm / 55 mm	K4-3P.E	K4-3P.E_ESD
1000 mm / 55 mm	K4-3Q.E	K4-3Q.E_ESD
800 mm / 600 mm	K4-3N.F	K4-3N.F_ESD
900 mm / 600 mm	K4-3P.F	K4-3P.F_ESD
1000 mm / 600 mm	K4-3Q.F	K4-3Q.F_ESD

primus one

System corner shelf element



Technical features

- System shelf element made of 30 mm HPL coated board, front edging rounded
- Shelf will be fixed between the system profiles of the tables
- ESD [Electrostatic Discharge] variant for EPA [Electrostatic Protective Area] facilities

primus one

System corner shelf element

Technical data

Shelf panel	
Thickness	30 mm
Coating	HPL laminate 0.8 mm, non-glare, abrasion-resistant in accordance with EN 438, heat-resistant for short periods
Colour	light grey RAL 7035
Load capacity	
Weight loading	80 kg Surface load capacity up to 1600 mm width 60 kg Surface load capacity up to 2000 mm width
ESD variant	
Table top	Same properties as standard model but volume-conductive
Configuration	DIN EN 61340-5-1 Part 5-1
Dimension	
Width instrument shelf	1200 mm, 1500 mm, 1600 mm, 1800 mm, 2000 mm
Depth	400 mm
Height	30 mm
Table width	55 mm, 600 mm

Ordering no.

Width	Standard (including system carrier)	ESD (including system carrier) 
800 mm / 55 mm	K4-7N.SE	K4-7N.SE_ESD
900 mm / 55 mm	K4-7P.SE	K4-7P.SE_ESD
1000 mm / 55 mm	K4-7Q.SE	K4-7Q.SE_ESD
800 mm / 600 mm	K4-7N.SF	K4-7N.SF_ESD
900 mm / 600 mm	K4-7P.SF	K4-7P.SF_ESD
1000 mm / 600 mm	K4-7Q.SF	K4-7Q.SF_ESD

A primus one



Shelfelements

A3

primus one

System-function shelf



Technical features

- Function shelf can be steplessly tilted by 30°
- Slide-prevention edging at the front and the back
- Stepless height adjustment
- ESD [Electrostatic Discharge] variant for EPA [Electrostatic Protective Area] facilities
- Two heavy-duty grooves are provided, one at the top and one at the bottom

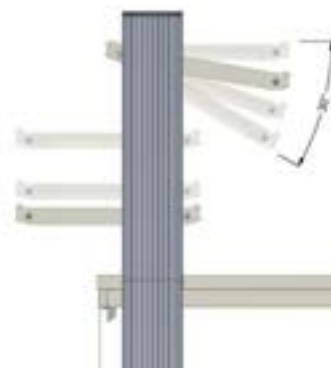

primus one

System-function shelf

Technical data

Shelf panel	
Thickness	19 mm
Coating	Melamine coating, resistant to organic solvents, weak acids, gasoline and oil
Colour	light grey RAL 7035
Load capacity	
Weight loading	80 kg Surface load capacity up to 1600 mm width 60 kg Surface load capacity up to 2000 mm width
ESD variant	
Table top	Same properties as standard model but volume-conductive
Configuration	DIN EN 61340-5-1 Part 5-1
Dimension	
Width function shelf	975 mm, 1275 mm, 1375 mm, 1575 mm, 1775 mm
Depth	400 mm
Height	88 mm

Ordering no.

Width / for table width	Standard	ESD 
975 mm / 1200 mm	K4-3E	K4-3L
1275 mm / 1500 mm	K4-3D	K4-3K
1375 mm / 1600 mm	K4-3C	K4-3J
1575 mm / 1800 mm	K4-3B	K4-3H
1775 mm / 2000 mm	K4-3A	K4-3G

Suitable system profile (1Pair)

Length: 510 mm For equipping with 480 mm insert panel	K5-1P.0510
--	------------

Suitable accessories

Function tray	for table width	Height	Depth	Ordering no. 
	1200 mm	83 mm	90 mm	K9-4K.B1200
	1500 mm	83 mm	90 mm	K9-4K.B1500
	1600 mm	83 mm	90 mm	K9-4K.B1600
	1800 mm	83 mm	90 mm	K9-4K.B1800
	2000 mm	83 mm	90 mm	K9-4K.B2000

primus one

System-Instrument shelf

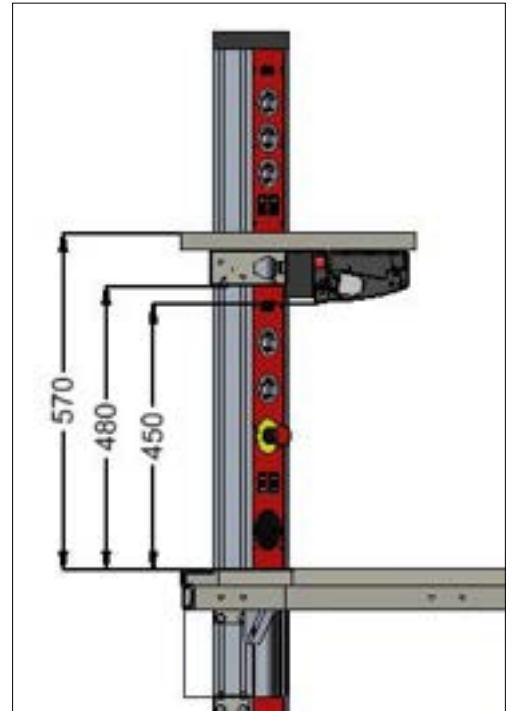

Technical features

- System shelf element made of 30 mm HPL coated board, front edging rounded
- LED lighting can be integrated
- Orga panel can be integrated
- Shelf element prepared on each side for downward routing of cable
- ESD [Electrostatic Discharge] variant for EPA [Electrostatic Protective Area] facilities

Note:

Including system carrier

Orga panel available separately

primus one

System-Instrument shelf

Technical data

Shelf panel	
Thickness	30 mm
Coating	HPL laminate 0.8 mm, non-glare, abrasion-resistant in accordance with EN 438, heat-resistant for short periods
Colour	light grey RAL 7035
Load capacity	
Weight loading	100 kg Surface load capacity
ESD variant	
Table top	Same properties as standard model but volume-conductive
Configuration	DIN EN 61340-5-1 Part 5-1
Dimension	
Width instrument shelf	1200 mm, 1500 mm, 1600 mm, 1800 mm, 2000 mm
Depth	400 mm
Height	30 mm (+60 mm System carrier)

Ordering no.

Width	Standard (including system carrier)	ESD (including system carrier) 
1200 mm	K4-7E.S	K4-7L.S
1500 mm	K4-7D.S	K4-7K.S
1600 mm	K4-7C.S	K4-7J.S
1800 mm	K4-7B.S	K4-7H.S
2000 mm	K4-7A.S	K4-7G.S

Suitable system profile (1 pair)

Length: 570 mm For equipping with 480 mm insert panel	K5-1P.0570
--	------------

primus one

3HU System-Instrument shelf partially equipped

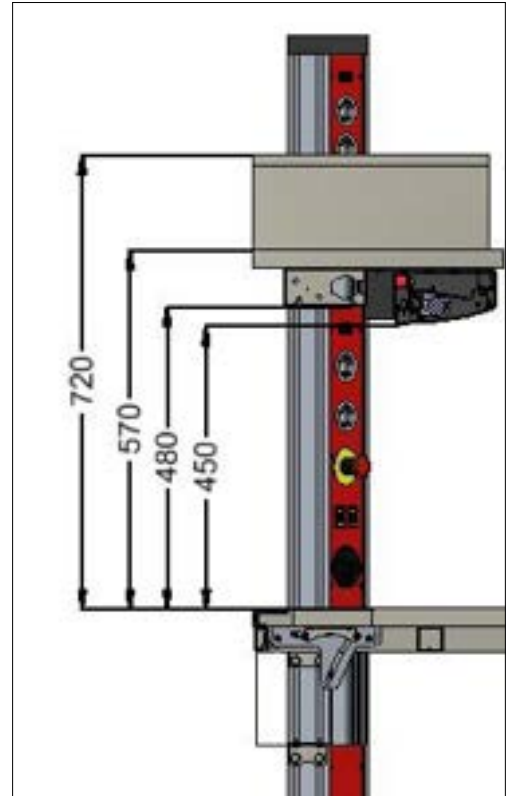

Technical features

- Storage area for customer's own measuring devices and power supplies
- Possibility of equipping with Elabo components
- LED lighting can be integrated
- Orga panel can be integrated for shelf element
- Shelf element prepared on each side for downward routing of cable
- ESD [Electrostatic Discharge] variant for EPA [Electrostatic Protective Area] facilities



Note:

Including system carrier

Orga panel available separately

primus one

3HU System-Instrument shelf partially equipped

Technical data

Shelf panel			
Thickness	30 mm		
Coating	HPL laminate 0.8 mm, non-glare, abrasion-resistant in accordance with EN 438, heat-resistant for short periods		
Colour	light grey RAL 7035		
ESD variant			
Table top	Same properties as standard model but volume-conductive		
Configuration	DIN EN 61340-5-1 Part 5-1		
Dimension	Width	Mounting width	Storage area
Width / Equipment	1200 mm	114HP	465 mm
	1500 mm	114HP	765 mm
	1600 mm	168HP	590 mm
	1800 mm	168HP	790 mm
	2000 mm	168HP	990 mm
Depth	400 mm		
Height	Shelf: 30 mm (+60 mm system carrier) Superstructure: 180 mm (+60 mm system carrier)		

Ordering no. superstructure left side

Width	Standard (including system carrier)	ESD (including system carrier) 
1200 mm	K4-7E.S3HU	K4-7L.S3HU
1500 mm	K4-7D.S3HU	K4-7K.S3HU
1600 mm	K4-7C.S3HU	K4-7J.S3HU
1800 mm	K4-7B.S3HU	K4-7H.S3HU
2000 mm	K4-7A.S3HU	K4-7G.S3HU

Ordering no. superstructure right side

Width	Standard (including system carrier)	ESD (including system carrier) 
1200 mm	K4-7E.S3HU-RE	K4-7L.S3HU-RE
1500 mm	K4-7D.S3HU-RE	K4-7K.S3HU-RE
1600 mm	K4-7C.S3HU-RE	K4-7J.S3HU-RE
1800 mm	K4-7B.S3HU-RE	K4-7H.S3HU-RE
2000 mm	K4-7A.S3HU-RE	K4-7G.S3HU-RE

Suitable system profile (1 pair)

Length: 570/720 mm For equipping with 480 mm insert panel Including system carrier	K5-1P.0570_0720
--	-----------------

primus one

6HU System-Instrument shelf partially equipped

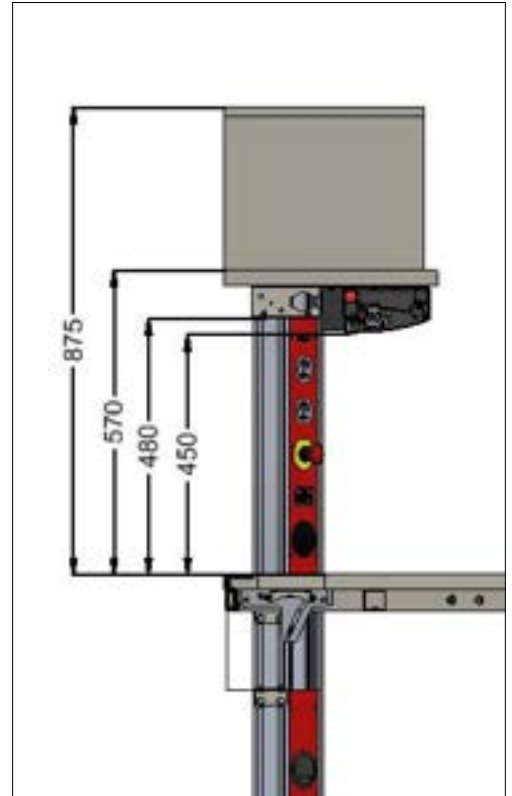

Technical features

- Storage area for customer's own measuring devices and power supplies
- Possibility of equipping with Elabo components
- LED lighting can be integrated
- Orga panel can be integrated for shelf element
- Shelf element prepared on each side for downward routing of cable
- ESD [Electrostatic Discharge] variant for EPA [Electrostatic Protective Area] facilities



Note:

Including system carrier

Orga panel available separately

primus one

6HU System-Instrument shelf partially equipped

Technical data

Shelf panel			
Thickness	30 mm		
Coating	HPL laminate 0.8 mm, non-glare, abrasion-resistant in accordance with EN 438, heat-resistant for short periods		
Colour	light grey RAL 7035		
ESD variant			
Table top	Same properties as standard model but volume-conductive		
Configuration	DIN EN 61340-5-1 Part 5-1		
Dimension	Width	Mounting width	Storage area
Width / Equipment	1200 mm	114HP	465 mm
	1500 mm	114HP	765 mm
	1600 mm	168HP	590 mm
	1800 mm	168HP	790 mm
	2000 mm	168HP	990 mm
Depth	400 mm		
Height	Shelf: 30 mm (+60 mm system carrier) Superstructure: 180 mm (+60 mm system carrier)		

Ordering no. superstructure left side

Width	Standard (including system carrier)	ESD (including system carrier) 
1200 mm	K4-7E.S6HU	K4-7L.S6HU
1500 mm	K4-7D.S6HU	K4-7K.S6HU
1600 mm	K4-7C.S6HU	K4-7J.S6HU
1800 mm	K4-7B.S6HU	K4-7H.S6HU
2000 mm	K4-7A.S6HU	K4-7G.S6HU

Ordering no. superstructure right side

Width	Standard (including system carrier)	ESD (including system carrier) 
1200 mm	K4-7E.S6HU-RE	K4-7L.S6HU-RE
1500 mm	K4-7D.S6HU-RE	K4-7K.S6HU-RE
1600 mm	K4-7C.S6HU-RE	K4-7J.S6HU-RE
1800 mm	K4-7B.S6HU-RE	K4-7H.S6HU-RE
2000 mm	K4-7A.S6HU-RE	K4-7G.S6HU-RE

Suitable system profile (1 pair)

Length: 570/875 mm For equipping with 480 mm insert panel Including system carrier	K5-1P.0570_0875
--	-----------------

A primus one



Superstructures

A4

primus one

System-Superstructure



Technical features

- Space-saving power supply systems
- Light grey coated extruded aluminium profile
- Installation of simple power supply systems
- Already designed with a 3-phase wiring, the supply channel can be equipped immediately
- The duct is fastened to the tabletop
- Cable outlets at the side and underneath allow simple cable routing
- In order to equip the ducts, you can use the System 3HU power supply strips
- The desktop rack widths are determined acc. DIN 41494 in HP = Horizontal pitch = 5.08 mm; this means that the holding capacity is for 3 HU built-in components.. The installation height is uniform 6HU (1 HU = unit of Height = 44.45 mm).

primus one

System-Superstructure

Technical data

Description			Order-No.
<p>Power supply duct System 3HE</p> <p>For holding 388HU For holding 348HU For holding 308HU For holding 288HU For holding 228HU</p> <p>D = 160 mm; H = 142 mm</p> <p>Cover strips, suitable for groove width 8.4 mm. Colour: silver grey Customer can cut to size for the appropriate duct width</p> <p>W = 2000 mm, D = 9 mm, H = 7 mm</p>		<p>W = 2000 mm W = 1800 mm W = 1600 mm W = 1500 mm W = 1200 mm</p>	<p>40-4Y 40-4A 40-4D 40-4B 40-4C</p> <p>81-6N</p>
<p>Column rack</p> <p>For training areas near to experimenting walls or as a space-saving alternative in the laboratory and the workshop</p> <p>3HU, 4 x 60HU</p> <p>W = 353 mm, D = 320 mm, H = 569 mm</p>			<p>40-0K</p>
<p>System-Superstructure 6HU</p> <p>to equip with ELABO cassettes 6HU in 5,08mm grid according to norm DIN41494</p> <p>For holding 6HU/372HP For holding 6HU/330HP For holding 6HU/294HP For holding 6HU/270HP For holding 6HU/216HP</p> <p>D = 400 mm, H = 360 mm, Front 4,5°</p> <p>Note: Profile is additionally necessary.</p>		<p>W = 2000 mm W = 1800 mm W = 1600 mm W = 1500 mm W = 1200 mm</p> <p>L = 360 mm</p>	<p>K4-4A.X01 K4-4B.X01 K4-4C.X01 K4-4D.X01 K4-4E.X01</p> <p>K5-1P.0360</p>

Assembly example:

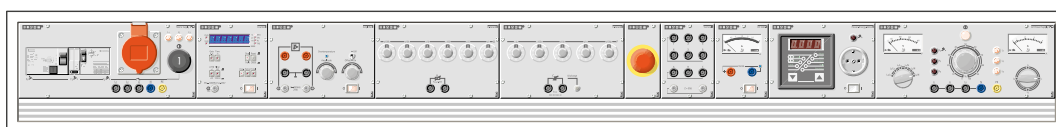
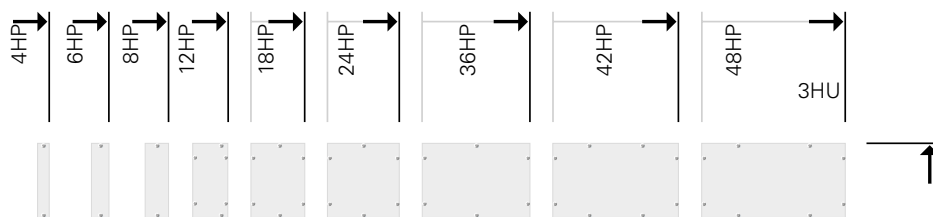

primus one

System-Superstructure 3HU

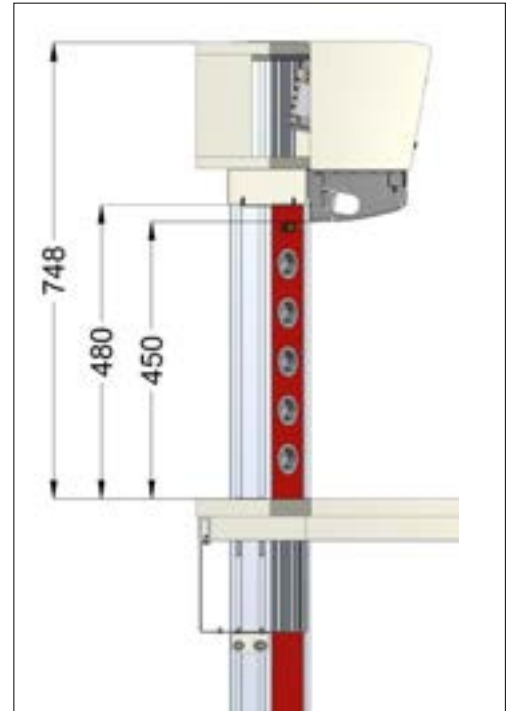

Technical features

- Ergonomically inclined towards the user (front inclination)
- Completely electrically pre-wired with device connections
- Can be fitted with Elabo devices or third-party devices
- Removable metal rear wall
- Retrofittable LED lighting
- Retrofittable Orga panel
- ESD [Electrostatic Discharge] variant for EPA [Electrostatic Protective Area] facilities



Note:
Including system carrier
Orga panel available separately

primus one

System-Superstructure 3HU

Technical data

Body		
Thickness	19 mm	
Coating	Melamine coating, resistant to organic solvents, weak acids, gasoline and oil	
Colour	light grey RAL 7035	
ESD variant		
Configuration	DIN EN 61340-5-1 Part 5-1 Body volume-conductive	
Dimension	Width	Equipment
Width	1200 mm	216HP
	1500 mm	270HP
	1600 mm	294HP
	1800 mm	330HP
	2000 mm	372HP
Depth		Top: 386 mm Bottom: 350 mm
Height	3HU	210 mm (270 mm with system carrier)

Ordering no.

Width	Standard (including system carrier)	ESD (including system carrier) 
1200 mm	K4-2E	K4-2L
1500 mm	K4-2D	K4-2K
1600 mm	K4-2C	K4-2J
1800 mm	K4-2B	K4-2H
2000 mm	K4-2A	K4-2G

Suitable system profile (1 pair)

Length: 748 mm For equipping with 480 mm insert panel	K5-1P.0748
--	------------

primus one

System-Superstructure 6HU

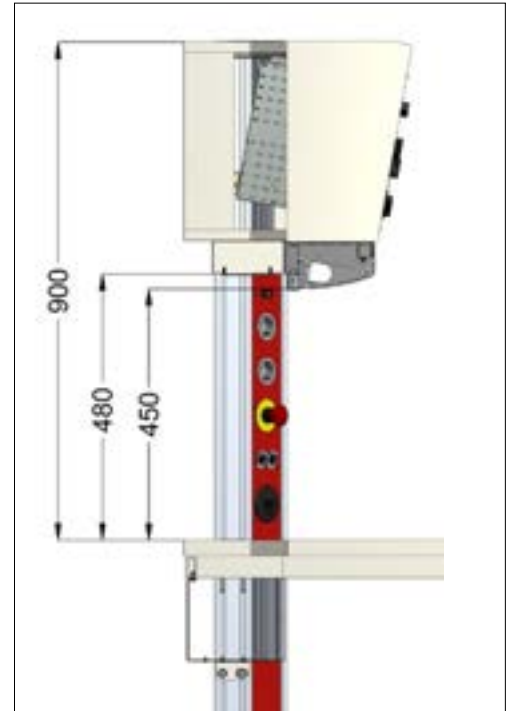

Technical features

- Ergonomically inclined towards the user (front inclination)
- Completely electrically pre-wired with device connections
- Can be fitted with Elabo devices or third-party devices
- Seamless integration of 19" devices
- Removable metal rear wall
- Retrofittable LED lighting
- Retrofittable Orga panel
- ESD [Electrostatic Discharge] variant for EPA [Electrostatic Protective Area] facilities



Note:

Including system carrier

Orga panel available separately

primus one

System-Superstructure 6HU

Technical data

Body		
Thickness	19 mm	
Coating	Melamine coating, resistant to organic solvents, weak acids, gasoline and oil	
Colour	light grey RAL 7035	
ESD variant		
Configuration	DIN EN 61340-5-1 Part 5-1 Body volume-conductive	
Dimension	Width	Equipment
Width	1200mm	216HP
	1500 mm	270HP
	1600 mm	294HP
	1800 mm	330HP
	2000 mm	372HP
Depth		Top: 412 mm Bottom: 350 mm
Height	6HU	360 mm (420 mm with system carrier)

Ordering no.

Width	Standard (including system carrier)	ESD (including system carrier) 
1200 mm	K4-4E	K4-4L
1500 mm	K4-4D	K4-4K
1600 mm	K4-4C	K4-4J
1800 mm	K4-4B	K4-4H
2000 mm	K4-4A	K4-4G

Suitable system profile (1 pair)

Length: 900 mm For equipping with 480 mm insert panel	K5-1P.0900
--	------------

Suitable accessories

ELABO Primus One 19" adaption to integrate 19" insert panels and electrical inserts Consisting of: 2x 6HU angles, 2x guide rails , 2x insert panel, fixing material	K9-4A
--	-------

primus one

System-Shelf superstructure

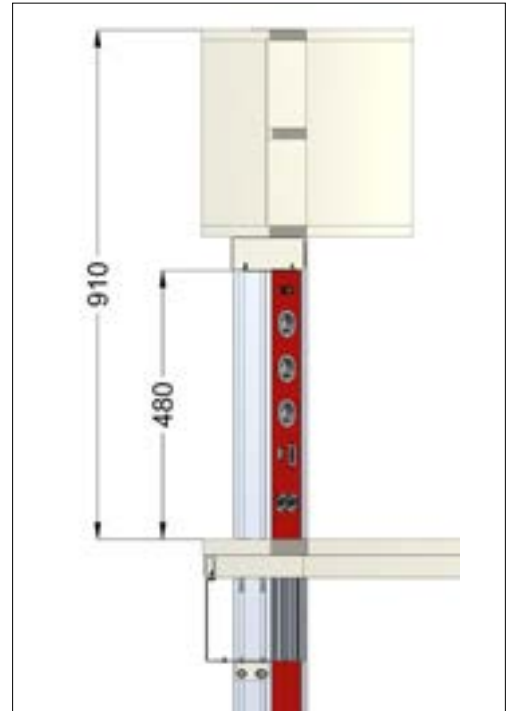

Technical features

- Storage space directly at the workplace
- Suitable for DIN A4 file
- Shelf version including one height-adjustable shelf
- Retrofittable LED lighting
- Retrofittable Orga panel
- ESD [Electrostatic Discharge] variant for EPA [Electrostatic Protective Area] facilities
- Superstructure can be equipped with electric sockets, for example

Note:

Pay attention whether the design is with or without a system carrier

Orga panel separately available only for superstructure with system carrier

Shelf superstructure can be fitted with 330 mm insert panels



primus one

System-Shelf superstructure

Technical data

Body		
Thickness	19 mm	
Coating	Melamine coating, resistant to organic solvents, weak acids, gasoline and oil	
Colour	light grey RAL 7035	
ESD variant		
Configuration	DIN EN 61340-5-1 Part 5-1 Body volume-conductive	
Dimension		
Width		
Width	1200 mm, 1500 mm, 1600 mm, 1800 mm, 2000 mm	
Depth	Outside	375 mm
	Inside	356 mm
Height	Outside	370 mm (430 mm with system carrier)
	Inside	330 mm

Ordering no.

Width	Standard	ESD 	Without system carrier	Without system carrier ESD 
1200 mm	K4-5E	K4-5L	K4-5E.1	K4-5L.1
1500 mm	K4-5D	K4-5K	K4-5D.1	K4-5K.1
1600 mm	K4-5C	K4-5J	K4-5C.1	K4-5J.1
1800 mm	K4-5B	K4-5H	K4-5B.1	K4-5H.1
2000 mm	K4-5A	K4-5G	K4-5A.1	K4-5G.1

Suitable system profile (1 pair)

Length: 372 mm For installing shelf unit directly on top of an electrical superstructure For equipping with 330 mm insert panel	K5-1P.0372
Length: 910 mm For installation of a shelf unit over a table For equipping with 480 mm + 330 mm insert panel	K5-1P.0910

primus one

System-Roller-shutter superstructure

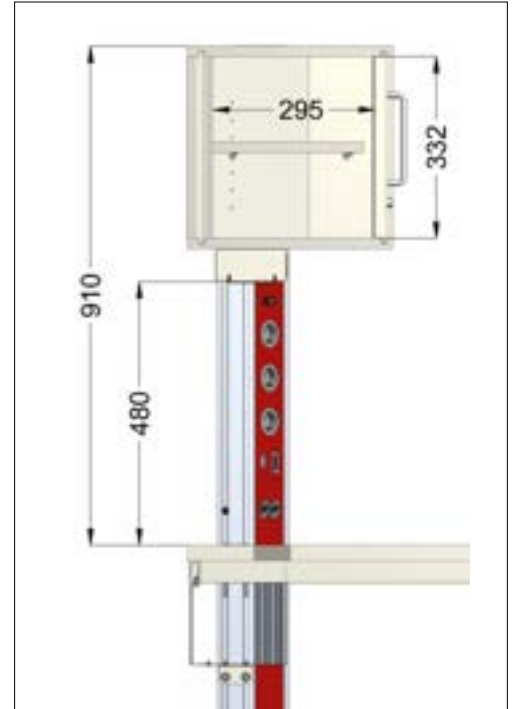

Technical features

- Storage space directly at the workplace
- Suitable for DIN A4 file
- Roller shutter superstructure with lock and foldable key, optionally centrally lockable
- Retrofittable LED lighting
- Retrofittable Orga panel

Note:

Pay attention whether the design is with or without a system carrier

Orga panel separately available only for superstructure with system carrier

primus one

System-Roller-shutter superstructure

Technical data

Body		
Thickness	19 mm	
Coating	Melamine coating, resistant to organic solvents, weak acids, gasoline and oil	
Colour	light grey RAL 7035	
Dimension		
Width	1200 mm, 1500 mm, 1600 mm, 1800 mm, 2000 mm	
Depth	Outside	375 mm
	Inside	295 mm
Height	Outside	370 mm (430 mm with system carrier)
	Inside	332 mm

Ordering no.

Width	Standard	Without system carrier
1200 mm	K4-6E	K4-6E.1
1500 mm	K4-6D	K4-6D.1
1600 mm	K4-6C	K4-6C.1
1800 mm	K4-6B	K4-6B.1
2000 mm	K4-6A	K4-6A.1

Suitable system profile (1 pair)

Length: 372 mm For installing shelf unit directly on top of an electrical superstructure	K5-1P.0372
Length: 910 mm For installation of a shelf unit over a table For equipping with 480 mm insert panel	K5-1P.0910

primus one

System-Sliding-door superstructure

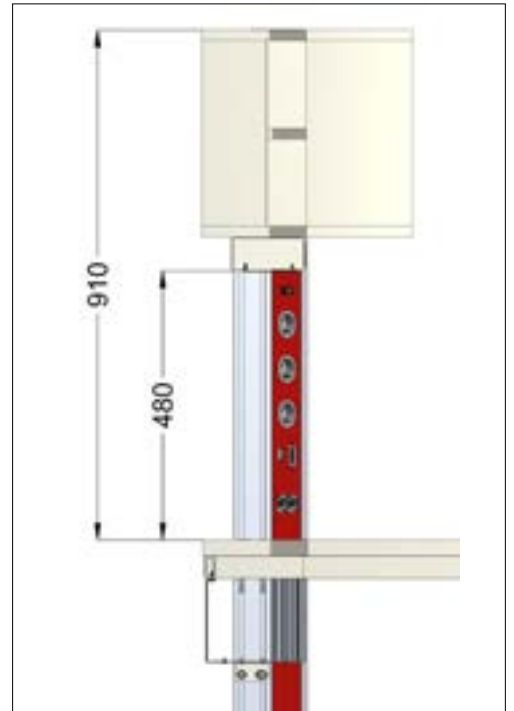

Technical features

- Storage space directly at the workplace
- Suitable for DIN A4 file
- Sliding door with lock and foldable key, optionally centrally lockable
- Retrofittable LED lighting
- With partition panel and height-adjustable shelf

Note:

Pay attention whether the design is with or without a system carrier

Orga panel separately available only for superstructure with system carrier

Sliding-doors superstructure with 330 mm insert panels



primus one

System-Sliding-door superstructure

Technical data

Body		
Thickness	19 mm	
Coating	Melamine coating, resistant to organic solvents, weak acids, gasoline and oil	
Colour	light grey RAL 7035	
ESD variant		
Configuration	DIN EN 61340-5-1 Part 5-1 Body volume-conductive	
Dimension		
Width		
Width	1200 mm, 1500 mm, 1600 mm, 1800 mm, 2000 mm	
Depth	Outside	375 mm
	Inside	296 mm
Height	Outside	370 mm (430 mm with System carrier)
	Inside	332 mm

Ordering no.

Width	Standard	ESD 	Without System carrier	Without System carrier ESD 
1200 mm	K4-8E	K4-8L	K4-8E.1	K4-8L.1
1500 mm	K4-8D	K4-8K	K4-8D.1	K4-8K.1
1600 mm	K4-8C	K4-8J	K4-8C.1	K4-8J.1
1800 mm	K4-8B	K4-8H	K4-8B.1	K4-8H.1
2000 mm	K4-8A	K4-8G	K4-8A.1	K4-8G.1

Suitable system profile (1pair)

Length: 370 mm For installing shelf unit directly on top of an electrical superstructure For equipping with 330 mm insert panel	K5-1P.0370
Length: 910 mm For installation of a shelf unit over a table For equipping with 480 mm + 330 mm insert panel	K5-1P.0910

A primus one



System profiles

A5

primus one

System profiles



Technical features

- Aluminum profiles (extruded sections) for maximum strength
- Heavy-load slot nuts for mounting accessories such as PC holders
- High-grade anodized surface
- Columns designed as "vertical ducts"
- Cable chambers inside for tidy routing of cables
- Suitable for installation of profi led work surfaces
- Vertically extendable by means of an invisible patented fastening technology (on the rear table legs)

Technical data

Description	Length	Ordering no.
Extension above function shelf	240 mm	K5-1P.0240
Extension above superstructure or table	270 mm	K5-1P.0270
For installing shelf-unit directly on an electrical superstructure	372 mm	K5-1P.0372
Extension above function shelf	480 mm	K5-1P.0480
For "open-end" configurations / function shelves	510 mm	K5-1P.0510
For instrument shelf	570 mm	K5-1P.0570
For 3HU superstructures	748 mm	K5-1P.0748
For 6HU superstructures	900 mm	K5-1P.0900
For installing roller-shutter / shelf unit superstructures directly on the table	910 mm	K5-1P.0910
System profile for 2 x 480 mm equipping	990 mm	K5-1P.0990



Insert panels

A6

primus one

System-Insert panel



Technical features

- Individual configuration of the workplace
- All profile panels available in three standard colours
- Different colours available on request
- Choose from a wide range of equipment variants

Standard colours:

Traffic red	RAL3020
Black grey	RAL7021
Signal blue	RAL5005

Individual colour available on request.





Note:

Fuse protection units are listed at the end of this chapter

primus one

System-Insert panel



Technical data

Description			Ordering no.
<p>Single-phase power switch</p> <p>Mains voltage 1 / N / PE ~50 Hz 230 V 16 A</p> <p>W = 80 mm, H = 240 mm</p> <p>Equipment: 1 Off button 1 keyed On button 1 phase control lamp</p>		<p>Insert panel traffic red</p> <p>Insert panel signal blue</p> <p>Insert panel black grey</p>	<p>K5-1A02DE.240.3020</p> <p>K5-1A02DE.240.5005</p> <p>K5-1A02DE.240.7021</p>
<p>Three-phase power switch</p> <p>Mains voltage 3 / N / PE ~50 Hz 400 V 16A</p> <p>W = 80 mm, H = 240 mm</p> <p>Equipment: 1 Off button 1 keyed On button 3 phase control lamps</p>		<p>Insert panel traffic red</p> <p>Insert panel signal blue</p> <p>Insert panel black grey</p>	<p>K5-1B01DE.240.3020</p> <p>K5-1B01DE.240.5005</p> <p>K5-1B01DE.240.7021</p>
<p>Single-phase power switch with voltage supply</p> <p>Mains voltage 1 / N / PE ~50 Hz 230 V 16A</p> <p>W = 80 mm, H = 480 mm</p> <p>Equipment: 1 Off button 1 keyed On button 1 phase control lamp 3 Schuko sockets (type F)</p>		<p>Insert panel traffic red</p> <p>Insert panel signal blue</p> <p>Insert panel black grey</p>	<p>K5-1A12DE.480.3020</p> <p>K5-1A12DE.480.5005</p> <p>K5-1A12DE.480.7021</p>
<p>Single-phase power switch with voltage supply</p> <p>Mains voltage 1 / N / PE ~50 Hz 230 V 16 A</p> <p>W = 80 mm, H = 480 mm</p> <p>With black key push off-bottom designed as an quick off switch.</p> <p>Equipment: 1 Keyed Push-Off button switch, black 1 phase control lamp 3 Schuko sockets (type F) 3 safety lab terminals</p>		<p>Insert panel traffic red</p> <p>Insert panel signal blue</p> <p>Insert panel black grey</p>	<p>K5-1A13DE.480.3020</p> <p>K5-1A13DE.480.5005</p> <p>K5-1A13DE.480.7021</p>

primus one

System-Insert panel



Technical data

Description			Ordering no.
<p>Single-phase power switch with voltage supply and protection</p> <p>Mains voltage 1 / N / PE ~50 Hz 230 V 16 A</p> <p>W = 80 mm, H = 480 mm</p> <p>Equipment :</p> <ul style="list-style-type: none"> 1 Off button 1 keyed On button 1 phase control lamp 1 circuit breaker 16 A type B 1 30 mA type A 1 Schuko socket (type F) 		<p>Insert panel traffic red</p> <p>Insert panel signal blue</p> <p>Insert panel black grey</p>	<p>K5-1C01DE.480.3020</p> <p>K5-1C01DE.480.5005</p> <p>K5-1C01DE.480.7021</p>
<p>Three-phase power switch with voltage supply</p> <p>Mains voltage 3 / N / PE ~50 Hz 400 V 16 A</p> <p>W = 80 mm, H = 480 mm</p> <p>Equipment :</p> <ul style="list-style-type: none"> 1 Off button 1 keyed On button 3 phase control lamps 1 CEE socket 5 safety lab terminals 1 Schuko socket (type F) 		<p>Insert panel traffic red</p> <p>Insert panel signal blue</p> <p>Insert panel black grey</p>	<p>K5-1B01DE.480.3020</p> <p>K5-1B01DE.480.5005</p> <p>K5-1B01DE.480.7021</p>
<p>Single phase power switch with voltage supply</p> <p>Mains voltage 1 / N / PE ~50 Hz 230 V 16 A</p> <p>W = 80 mm, H = 480 mm</p> <p>Equipment:</p> <ul style="list-style-type: none"> 1 Off button 1 Keyed On button 1 Phase control lamps 3 Schuko sockets (type F) 3 Safety lab terminals 		<p>Insert panel traffic red</p> <p>Insert panel signal blue</p> <p>Insert panel black grey</p>	<p>K5-1A11DE.480.3020</p> <p>K5-1A11DE.480.5005</p> <p>K5-1A11DE.480.7021</p>

primus one

System-Insert panel



Technical data

Description			Ordering no.
<p>Three-phase power switch with voltage supply</p> <p>Mains voltage 3 / N / PE ~50 Hz 400 V 16 A</p> <p>W =80 mm, H = 480 mm</p> <p>With black Key Push Off-button designed as an Quick/Off switch</p> <p>Equipment: 1 Keyed Push Off-button 3 Phase control lamps 1 CEE socket 1 Schuko socket (type F) 5 Safety lab terminals</p>		<p>Insert panel traffic red</p> <p>Insert panel signal blue</p> <p>Insert panel black grey</p>	<p>K5-1B06DE.480.3020</p> <p>K5-1B06DE.480.5005</p> <p>K5-1B06DE.480.7021</p>
<p>Three-phase power switch with voltage supply</p> <p>Mains voltage 3 / N / PE ~50 Hz 400 V 16 A</p> <p>W =80 mm, H = 480 mm</p> <p>Equipment: 1 Off button 1 Keyed On button 3 Phase control lamps 1 CEE socket 1 Emergency Off Switch, unwired 5 Safety lab terminals</p>		<p>Insert panel traffic red</p> <p>Insert panel signal blue</p> <p>Insert panel black grey</p>	<p>K5-1B08DE.480.3020</p> <p>K5-1B08DE.480.5005</p> <p>K5-1B08DE.480.7021</p>
<p>Power supply panel with Emergency off</p> <p>Mains voltage 1 / N / PE ~50 Hz 230 V 16 A</p> <p>W = 80 mm, H = 240 mm</p> <p>Equipment: 1 lighted rocker switch 1 Schuko socket (type F) 1 Emergency off switch, unwired</p>		<p>Insert panel traffic red</p> <p>Insert panel signal blue</p> <p>Insert panel black grey</p>	<p>K5-2B09DE.240.3020</p> <p>K5-2B09DE.240.5005</p> <p>K5-2B09DE.240.7021</p>

primus one

System-Insert panel



Technical data

Description			Ordering no.
<p>Universal power supply panel</p> <p>front panel colour RAL 3020 traffic red W = 80 mm, H = 480 mm</p> <p>All necessary basic supplies in a module:</p> <ul style="list-style-type: none"> - Fixed DC voltage with different Output voltages $\pm 15V$, $\pm 12V$ and $\pm 5V/1A$ switchable. Short circuit protection. - DC regulated output voltage 0...30V/1A with LC display. Short circuit protection. - Function Generator Waveforms: sine, triangle, square, logic Frequency range: 0.1Hz...200kHz Amplitude: Us 0...10V, 10mA setting accuracy Source Resistance: 5 Ohm - Three-phase generator Phase voltage: 0...10V (eff.) Adjustable Line voltage: 0...17,4V (eff.) Adjustable Line current: 400mA (max.) Frequency: 1...120Hz adjustable in 1Hz increments Short circuit protection - AC voltage AC fixed voltage: 2x 12V/0.2A 50Hz (mains frequency) <p>Equipment: 1 lighted rocker switch 3 LC displays 5 encoder with pressure point 14 laboratory safety receptacles</p> <p>Attention: Power supply is separately in the cable tray, System carrier or in the power supply switching unit mounted! Connecting cable length is 2m</p>		<p>Insert panel traffic red</p> <p>Insert panel signal blue</p> <p>Insert panel black grey</p>	<p>K5-5E00DE.480.3020</p> <p>K5-5E00DE.480.5005</p> <p>K5-5E00DE.480.7021</p>
<p>Power supply panel</p> <p>Mains voltage 1 / N / PE ~50 Hz 230 V 16 A</p> <p>W = 80mm, H = 240mm</p> <p>Equipment 2 Schuko sockets (type F) 1 lighted rocker switch</p>		<p>Insert panel traffic red</p> <p>Insert panel signal blue</p> <p>Insert panel black grey</p>	<p>K5-2A00DE.240.3020</p> <p>K5-2A00DE.240.5005</p> <p>K5-2A00DE.240.7021</p>
<p>Power supply panel</p> <p>Mains voltage 1 / N / PE ~50 Hz 230 V 16 A</p> <p>W = 80 mm, H = 480 mm</p> <p>Equipment 5 Schuko sockets (type F) 1 lighted rocker switch</p>		<p>Insert panel traffic red</p> <p>Insert panel signal blue</p> <p>Insert panel black grey</p>	<p>K5-2A00DE.480.3020</p> <p>K5-2A00DE.480.5005</p> <p>K5-2A00DE.480.7021</p>

primus one

System-Insert panel





Technical data

Description			Ordering no.
<p>Power supply panel with Emergency off</p> <p>Mains voltage 1 / N / PE ~50 Hz 230 V 16 A</p> <p>W = 80 mm, H = 480 mm</p> <p>Equipment: 1 lighted rocker switch 4 Schuko sockets (type F) 1 Emergency off switch, unwired</p>		<p>Insert panel traffic red</p> <p>Insert panel signal blue</p> <p>Insert panel black grey</p>	<p>K5-2B00DE.480.3020</p> <p>K5-2B00DE.480.5005</p> <p>K5-2B00DE.480.7021</p>
<p>Power supply panel with Keyed Push-Off switch</p> <p>Mains voltage 1 / N / PE ~50 Hz 230 V 16 A</p> <p>W = 80 mm, H = 480 mm</p> <p>Equipment: 1 lighted rocker switch 4 Schuko sockets (type F) 1 Red Push-Off switch , without yellow Emergency/Off ring, acting on the start-up power switch panel</p>		<p>Insert panel traffic red</p> <p>Insert panel signal blue</p> <p>Insert panel black grey</p>	<p>K5-2B01DE.480.3020</p> <p>K5-2B01DE.480.5005</p> <p>K5-2B01DE.480.7021</p>
<p>Power supply panel with network connections</p> <p>Mains voltage 1 / N / PE ~50 Hz 230 V 16 A</p> <p>W = 80 mm, H = 480 mm</p> <p>Equipment :</p> <p>1 lighted rocker switch 4 Schuko sockets (type F) 2 RJ45 Cat6e throughput receptacles</p>		<p>Insert panel traffic red</p> <p>Insert panel signal blue</p> <p>Insert panel black grey</p>	<p>K5-2D00DE.480.3020</p> <p>K5-2D00DE.480.5005</p> <p>K5-2D00DE.480.7021</p>

primus one

System-Insert panel

Technical data

Description			Ordering no.
<p>Power supply panel</p> <p>Mains voltage 3 / N / PE ~50 Hz 400 V 16 A</p> <p>W = 80 mm, H = 240 mm</p> <p>Equipment: 1 CEE-socket 5 Safety lab terminals</p>		<p>Insert panel traffic red</p> <p>Insert panel signal blue</p> <p>Insert panel black grey</p>	<p>K5-3A02DE.240.3020</p> <p>K5-3A02DE.240.5005</p> <p>K5-3A02DE.240.7021</p>
<p>Power supply panel with PC multimedia port</p> <p>Mains voltage 1 / N / PE ~50 Hz 230 V 16 A</p> <p>W = 80 mm, H = 240 mm</p> <p>Equipment: 1 lighted rocker switch 1 Schuko socket (type F) 1 PC multimedia port equipped with - 3 USB connections - 2 audio connections, 3.5-mm jack plug - 1 Multi-card reader for SD / MMC / SDHC / MS / MS pro / MS duo / MS pro duo - 1.2-m connection lines with 2 USB/2 pin</p>		<p>Insert panel traffic red</p> <p>Insert panel signal blue</p> <p>Insert panel black grey</p>	<p>K5-2D01DE.240.3020</p> <p>K5-2D01DE.240.5005</p> <p>K5-2D01DE.240.7021</p>
<p>Power supply panel with PC multimedia port</p> <p>Mains voltage 1/N/PE ~50 Hz 230 V 16 A</p> <p>W = 80 mm, H = 480 mm</p> <p>Equipment: 1 lighted rocker switch 4 Schuko sockets (type F) 1 PC multimedia port equipped with - 3 USB connections - 2 audio connections, 3.5-mm jack plug - 1 Multi-card reader for SD / MMC / SDHC / MS / MS pro / MS duo / MS pro duo - 1.2-m connection lines with 2 USB/2 pin</p>		<p>Insert panel traffic red</p> <p>Insert panel signal blue</p> <p>Insert panel black grey</p>	<p>K5-2D01DE.480.3020</p> <p>K5-2D01DE.480.5005</p> <p>K5-2D01DE.480.7021</p>
<p>Data panel</p> <p>With cut-out Ø 60 mm for installing customary commercial flush-mounted systems and a PC multimedia port.</p> <p>W = 80 mm, H = 240 mm</p> <p>Equipment: 1 UAE (Universal Connection Unit) double socket (RJ45) 8/8 (8/8), category 6 shielded (unwired) UP (flush mount) 1 PC multimedia port equipped with - 3 USB connections - 2 audio connections, 3.5-mm jack plug - 1 Multi-card reader for SD / MMC / SDHC / MS / MS pro / MS duo / MS pro duo - 1.2-m connection lines with 2 USB/2 pin</p>		<p>Insert panel traffic red</p> <p>Insert panel signal blue</p> <p>Insert panel black grey</p>	<p>K5-2D02DE.240.3020</p> <p>K5-2D02DE.240.5005</p> <p>K5-2D02DE.240.7021</p>

primus one

System-Insert panel



Technical data

Description			Ordering no.
<p>Power supply panel with cable outlet</p> <p>Mains voltage 1 / N / PE ~50 Hz 230 V 16 A</p> <p>W = 80 mm, H = 330 mm</p> <p>Equipment : 1 lighted rocker switch 2 Schuko sockets (type F) 1 cable outlet Ø 60 mm, black</p>		<p>Insert panel traffic red</p> <p>Insert panel signal blue</p> <p>Insert panel black grey</p>	<p>K5-2D02DE.330.3020</p> <p>K5-2D02DE.330.5005</p> <p>K5-2D02DE.330.7021</p>
<p>Power supply panel with cable outlet</p> <p>Mains voltage 1 / N / PE ~50 Hz 230 V 16 A</p> <p>W = 80 mm, H = 480 mm</p> <p>Equipment : 1 lighted rocker switch 4 Schuko sockets (type F) 1 cable outlet Ø 60 mm, black</p>		<p>Insert panel traffic red</p> <p>Insert panel signal blue</p> <p>Insert panel black grey</p>	<p>K5-2D02DE.480.3020</p> <p>K5-2D02DE.480.5005</p> <p>K5-2D02DE.480.7021</p>
<p>Power supply panel with cable outlet Ø 60mm</p> <p>Mains voltage 1 / N / PE ~50 Hz 230 V 16 A</p> <p>W = 80 mm, H = 240 mm</p> <p>Equipment: 1 lighted rocker switch 1 Schuko socket (type F) 1 cable outlet Ø 60 mm, black</p>		<p>Insert panel traffic red</p> <p>Insert panel signal blue</p> <p>Insert panel black grey</p>	<p>K5-2D07DE.240.3020</p> <p>K5-2D07DE.240.5005</p> <p>K5-2D07DE.240.7021</p>
<p>Power supply panel</p> <p>Mains voltage 3 / N / PE ~50 Hz 400 V 16 A</p> <p>W = 80 mm, H = 240 mm</p> <p>Equipment : 1 CEE socket</p>		<p>Insert panel traffic red</p> <p>Insert panel signal blue</p> <p>Insert panel black grey</p>	<p>K5-3A00DE.240.3020</p> <p>K5-3A00DE.240.5005</p> <p>K5-3A00DE.240.7021</p>

primus one

System-Insert panel



Technical data

Description			Ordering no.
<p>Power supply panel with PC multimedia port and Emergency off</p> <p>Mains voltage 1 / N / PE ~50 Hz 230 V 16 A</p> <p>W = 80 mm, H = 480 mm</p> <p>Equipment: 1 lighted rocker switch 3 Schuko sockets (type F) 1 Emergency off switch, unwired 1 PC multimedia port equipped with - 3 USB connections - 2 audio connections, 3.5-mm jack plug - 1 Multi-card reader for SD / MMC / SDHC / MS / MS pro / MS duo / MS pro duo - 1.2-m connection lines with 2 USB/2 pin</p>		<p>Insert panel traffic red</p> <p>Insert panel signal blue</p> <p>Insert panel black grey</p>	<p>K5-2E00DE.480.3020</p> <p>K5-2E00DE.480.5005</p> <p>K5-2E00DE.480.7021</p>
<p>Power supply panel with network connections and Emergency off</p> <p>Mains voltage 1 / N / PE ~50 Hz 230 V 16 A</p> <p>W = 80 mm, H = 480 mm</p> <p>Equipment: 1 lighted rocker switch 3 Schuko sockets (type F) 1 Emergency off switch, unwired 2 RJ45 Cat6e throughput receptacles</p>		<p>Insert panel traffic red</p> <p>Insert panel signal blue</p> <p>Insert panel black grey</p>	<p>K5-2E02DE.480.3020</p> <p>K5-2E02DE.480.5005</p> <p>K5-2E02DE.480.7021</p>
<p>Blank panel</p> <p>W =80 mm, H = 120 mm</p>		<p>Insert panel traffic red</p> <p>Insert panel signal blue</p> <p>Insert panel black grey</p>	<p>K5-0L0000.120.3020</p> <p>K5-0L0000.120.5005</p> <p>K5-0L0000.120.7021</p>
<p>Blank panel</p> <p>W =80 mm, H = 240 mm</p>		<p>Insert panel traffic red</p> <p>Insert panel signal blue</p> <p>Insert panel black grey</p>	<p>K5-0L0000.240.3020</p> <p>K5-0L0000.240.5005</p> <p>K5-0L0000.240.7021</p>

primus one

System-Insert panel



Technical data

Description			Ordering no.
Blank panel (for assembly in shelf superstructure K4-..) W =80 mm, H = 330 mm		Insert panel traffic red	K5-0L0000.330.3020
		Insert panel signal blue	K5-0L0000.330.5005
		Insert panel black grey	K5-0L0000.330.7021
Blank panel (for driveable tables) W =80 mm, H = 413 mm		Insert panel traffic red	K5-0L0000.413.3020
		Insert panel signal blue	K5-0L0000.413.5005
		Insert panel black grey	K5-0L0000.413.7021
Blank panel W =80 mm, H = 480 mm		Insert panel traffic red	K5-0L0000.480.3020
		Insert panel signal blue	K5-0L0000.480.5005
		Insert panel black grey	K5-0L0000.480.7021
Power supply panel with PC-multimedia port, network connections and Emergency off switch Mains voltage 1/N/PE ~50 HZ 230 V 16 A W =80 mm, H = 480 mm Equipment: 1 lighted rocker switch 2 Schuko sockets (type F) 1 Emergency off switch, unwired 2 RJ45 Cat6e throughput receptacles 1 PC multimedia port equipped with - 3 USB connections - 2 audio connections, 3.5-mm jack plug - 1 Multi-card reader for SD / MMC / SDHC / MS / MS pro / MS duo / MS pro duo - 1.2-m connection lines with 2 USB/2 pin		Insert panel traffic red	K5-2E04DE.480.3020
		Insert panel signal blue	K5-2E04DE.480.5005
		Insert panel black grey	K5-2E04DE.480.7021
Data panel with network connection and cable outlet Ø 60 mm W = 80 mm, H = 330 mm Equipment : 4 RJ45 Cat6e throughput receptacles 1 cable outlet Ø 60 mm, black		Insert panel traffic red	K5-7D00DE.330.3020
		Insert panel signal blue	K5-7D00DE.330.5005
		Insert panel black grey	K5-7D00DE.330.7021

primus one

System-Insert panel





Technical data

Description		Ordering no.	
<p>Power supply panel with three-phase voltage ungrounded</p> <p>Mains voltage 1 / N / PE ~50 Hz 230 V 16 A</p> <p>W = 80 mm, H = 480 mm</p> <p>Equipment: 1 lighted rocker switch 4 Schuko sockets (type F) 1 socket without protective contact (230 VA) 1 Thermal-magnetic equipment circuit breakers 1 transformer with separate windings in the cable through</p>		Insert panel traffic red	K5-4A01DE.480.3020
<p>DC- Power supply panel</p> <p>Mains voltage 1 / N / PE ~50 Hz 230 V 16 A</p> <p>W = 80 mm, H = 240 mm</p> <p>1 Switched mode power supply Output voltage 24 V / 6 A Outputs to two safety lab terminals Voltage display on LED specification: Output power 150 W residual ripple 150 mVp-p Output tolerance +/- 1.0% Input control +/- 0.5% Load control +/- 0.5% Overload protection</p>		Insert panel traffic red	K5-5A00DE.240.3020
<p>Power supply panel AC / DC</p> <p>Mains voltage 1 / N / PE ~50 Hz 230 V 16 A</p> <p>W = 80 mm, H = 480 mm</p> <p>Equipment: 1 lighted rocker switch 2 Schuko sockets (type F) 1 Emergency off switch, unwired 1 RJ45 Cat6e throughput receptacle 1 Switched mode power supply with clocked output voltage 24 V / 6 A Outputs to 2 safety lab terminals Voltage display on LED specification: Output power 150 W residual ripple 150 mVp-p Output tolerance +/- 1.0% Input control +/- 0.5% Load control +/- 0.5% Overload protection</p>		Insert panel traffic red	K5-5A00DE.480.3020
		Insert panel signal blue	K5-5A00DE.480.5005
		Insert panel black grey	K5-5A00DE.480.7021

primus one

System-Insert panel

Technical data

Description			Ordering no.
<p>Data panel</p> <p>W = 80 mm, H = 240 mm</p> <p>Equipment: 1 installation switch Microsens 4-Port 10 / 100 2 USB throughput receptacles</p>		<p>Insert panel traffic red</p> <p>Insert panel signal blue</p> <p>Insert panel black grey</p>	<p>K5-7S00DE.240.3020</p> <p>K5-7S00DE.240.5005</p> <p>K5-7S00DE.240.7021</p>
<p>Power supply panel with two network connections</p> <p>Mains voltage 1 / N / PE ~50 Hz 230 V 16 A</p> <p>W = 80 mm, H = 240 mm</p> <p>Equipment: 1 lighted rocker switch 1 Schuko socket (type F) 2 RJ45 Cat6e throughput receptacles</p>		<p>Insert panel traffic red</p> <p>Insert panel signal blue</p> <p>Insert panel black grey</p>	<p>K5-2D09DE.240.3020</p> <p>K5-2D09DE.240.5005</p> <p>K5-2D09DE.240.7021</p>
<p>Compressed air supply</p> <p>W = 80 mm, H = 240 mm</p> <p>Equipment: 1 single-handed rapid action valve. Nominal size 5, thread 1 / 8" for tubing size 6 / 4 1 male coupling, nominal size 5 not connected</p>		<p>Insert panel traffic red</p> <p>Insert panel signal blue</p> <p>Insert panel black grey</p>	<p>K5-8A01DE.240.3020</p> <p>K5-8A01DE.240.5005</p> <p>K5-8A01DE.240.7021</p>
<p>Blank panel</p> <p>with cable outlet Ø 60 mm</p> <p>W = 80 mm, H = 240 mm</p> <p>Equipment: Two-part cable set, round, black, Ø 60 mm</p>		<p>Insert panel traffic red</p> <p>Insert panel signal blue</p> <p>Insert panel black grey</p>	<p>K5-0L0100.240.3020</p> <p>K5-0L0100.240.5005</p> <p>K5-0L0100.240.7021</p>
<p>Power supply panel with two network connections</p> <p>Mains voltage 1 / N / PE ~50 Hz 230 V 16 A</p> <p>W = 80 mm, H = 330 mm</p> <p>Equipment: 1 lighted rocker switch 3 Schuko sockets (type F) 2 RJ45 Cat6e throughput receptacles</p>		<p>Insert panel traffic red</p> <p>Insert panel signal blue</p> <p>Insert panel black grey</p>	<p>K5-2D00DE.330.3020</p> <p>K5-2D00DE.330.5005</p> <p>K5-2D00DE.330.7021</p>

ESD Monitor

for monitoring works at EPA workplaces, conform to standards



Technical features

- The daily check of the armband and proper connection of the table grounding will be carried out by the ESD-monitor automatically
- Control of persons grounding by two satellites (left + right)
- Both satellites equipped with park position for armband
- 8 LEDs showing status of monitored components
- Acoustic signal in case of incomplete grounding of a monitored component
- If fault won't be corrected within a specific time slot, table switches off automatically
- Individual colour available

Primus One®

Ordering No.	Type	Colour	Dimension
K5-1E00DE.480.3020	1 / N / PE	Insert panel traffic red	W = 80 mm, H = 480mm
K5-1E00DE.480.5005	1 / N / PE	Insert panel signal blue	W = 80 mm, H = 480mm
K5-1E00DE.480.7021	1 / N / PE	Insert panel black grey	W = 80 mm, H = 480mm
K5-1F00DE.480.3020	3 / N / PE	Insert panel traffic red	W = 80 mm, H = 480mm
K5-1F00DE.480.5005	3 / N / PE	Insert panel signal blue	W = 80 mm, H = 480mm
K5-1F00DE.480.7021	3 / N / PE	Insert panel black grey	W = 80 mm, H = 480mm

3HU Front panel

Ordering No.	Type	Colour	Dimension	
42-0X.3	1 / N / PE	Insert panel light grey	W = 213,3, H = 128,5 mm	42 HP
42-0Y.3	3 / N / PE	Insert panel light grey	W = 264,2, H = 128,5 mm	52 HP

Protection unit

Safety-Modul



Technical features

- To protect downstream equipment (power switch panel, power supply panels, socket strips, etc.) with residual current device type A or type B, single- or three phase.
- Positioned in the System carrier underneath superstructure or shelvelement



Note:

When using residual current device systems in teaching rooms and experimental facilities in which parts of the electrical equipment may create flat or pure residual currents (e.g. frequency inverters), the residual current device must absolutely be Type B (AC / DC sensitive) in accordance with VDE 0100, Part 723.412.5!

	K5-SM1.A	K5-SM1.B	K5-SM3.A	K5-SM3.B
Type	1 / N / PE		3 / N / PE	
Mains frequency	50 Hz / 60 Hz			
Nominal input voltage	230 V		400 V	
Maximum power output	16 A			
Residual current device	Type A	Type B	Type A	Type B
Trigger current	30 mA			

Safety Box

Technical data

Description			
RCD-Box Type B		<p>Primus/One RCD-Box for assembly at the Primus One support columns type K5-1P:xxxx, fixed with 2 screws into the grooves sideways. Colour RAL 7021 black grey, powdercoated.</p> <p>- Equipment</p> <p>1 Earth leakage circuit breaker (RCD) 25A 2pole, type B, rated leakage current 30mA W = 121.5 mm, H = 120 mm, D = 68.5 mm</p>	K5-SG1.B
RCD-Box Type B		<p>Primus/One RCD-Box for assembly at the Primus One support columns type K5-1P:xxxx, fixed with 2 screws into the grooves at the frontside. Colour RAL 7021 black grey, powdercoated.</p> <p>- Equipment</p> <p>1 Earth leakage circuit breaker (RCD) 25A 2pole, type B, rated leakage current 30mA W = 112 mm, H = 120 mm, D = 84.1 mm</p>	K5-SG1.B-1
RCD-Box Type A		<p>Primus/One RCD-Box for assembly at the Primus One support columns type K5-1P:xxxx, fixed with 2 screws into the grooves sideways. Colour RAL 7021 black grey, powdercoated.</p> <p>- Equipment</p> <p>1 Earth leakage circuit breaker (RCD) 25A 4pole, type A, rated leakage current 30mA W = 121.5 mm, H = 120 mm, D = 68.5 mm</p>	K5-SG3.A
RCD-Box Type A		<p>Primus/One RCD-Box for assembly at the Primus One support columns type K5-1P:xxxx, fixed with 2 screws into the grooves at the frontside. Colour RAL 7021 black grey, powdercoated.</p> <p>- Equipment</p> <p>1 Earth leakage circuit breaker (RCD) 25A 4pole, type A, rated leakage current 30mA W = 121.5 mm, H = 120 mm, D = 68.5 mm</p>	K5-SG3.A-1
RCD-Box Type B		<p>Primus/One RCD-Box for assembly at the Primus One support columns type K5-1P:xxxx, fixed with 2 screws into the grooves sideways. Colour RAL 7021 black grey, powdercoated.</p> <p>- Equipment</p> <p>1 Earth leakage circuit breaker (RCD) 25A 4pole, type B, rated leakage current 30mA W = 121.5 mm, H = 120 mm, D = 68.5 mm</p>	K5-SG3.B
RCD-Box Type B		<p>Primus/One RCD-Box for assembly at the Primus One support columns type K5-1P:xxxx, fixed with 2 screws into the grooves at the frontside. Colour RAL 7021 black grey, powdercoated.</p> <p>- Equipment</p> <p>1 Earth leakage circuit breaker (RCD) 25A 4pole, type B, rated leakage current 30mA W = 121.5 mm, H = 120 mm, D = 68.5 mm</p>	K5-SG3.B-1

Safety-Box alternating current

System-Safety-boxes



Technical features

- To protect downstream equipment (power switch panel, power supply panels, socket strips, etc.) with residual current device type A or type B, single- or three phase.
- Positioned in the table cable through, easily accessible via cable flap
- Mains power connection via terminal block

Note:







When using residual current device systems in teaching rooms and experimental facilities in which parts of the electrical equipment may create flat or pure residual currents (e.g. frequency inverters), the residual current device must absolutely be Type B (AC / DC sensitive) in accordance with VDE 0100, Part 723.412.5!

	K5-S1.A	K5-S1.B	K5-S3.A	K5-S3.B
Type	1 / N / PE		3 / N / PE	
Mains frequency	50 Hz / 60 Hz			
Nominal input voltage	230 V		400 V	
Maximum power output	16 A			
Residual current device	Type A	Type B	Type A	Type B
Trigger current	30 mA			
Dimensions	W = 299 mm , D = 81 mm , H = 80,5 mm			

primus one

Accessories

Technical data

Description		Ordering no.
<p>Cover panel </p> <p>W=976mm, 1276mm, 1376mm, 1576mm, 1776mm D = 60 mm, H = 540 mm</p> <p>Screen made of sheet metal, conductive, powder-coated.</p> <p>Euro-holes 9.5 x 9.5 mm Grid 38 mm x 38 mm</p>		<p>For table width 1200 mm K9-4S.B1200</p> <p>For table width 1500 mm K9-4S.B1500</p> <p>For table width 1600 mm K9-4S.B1600</p> <p>For table width 1800 mm K9-4S.B1800</p> <p>For table width 2000 mm K9-4S.B2000</p>
<p>Perforated panel </p> <p>W=976 mm, 1276 mm, 1376 mm, 1576 mm, 1776 mm D = 24 mm, H = 341 mm</p> <p>Perforated panel with Euro-standard holes 9,5 mm x 9,5 mm (spacing 38 mm) to hold brackets and organize elements Made of sheet steel, powder coated</p>		<p>For table width 1200 mm K9-4M.B1200</p> <p>For table width 1500 mm K9-4M.B1500</p> <p>For table width 1600 mm K9-4M.B1600</p> <p>For table width 1800 mm K9-4M.B1800</p> <p>For table width 2000 mm K9-4M.B2000</p>
<p>Interchangeable frame profile (2 pieces) </p> <p>W=976 mm, 1276 mm, 1376 mm, 1576 mm, 1776 mm D = 18 mm, H = 35 mm</p> <p>Interchangeable frame profile for insertion of small-parts containers, units and equipment shelves as well as training boards of all common teaching systems.</p> <p>Profiles:</p> <ul style="list-style-type: none"> - 2 anodized aluminum profiles with small groove on top and large groove on bottom to simplify insertion. - Fastening strap on each side to allow infinite height adjustment. - optionally with inner lying brush strip for noise reduction 		<p>For table width 1200 mm K9-4H.B1200</p> <p>For table width 1500 mm K9-4H.B1500</p> <p>For table width 1600 mm K9-4H.B1600</p> <p>For table width 1800 mm K9-4H.B1800</p> <p>For table width 2000 mm K9-4H.B2000</p>
<p>Hanging profile</p> <p>T = 15 mm, H = 30 mm B=1115; 1415, 1515; 1715, 1915 For hanging material trays</p> <p>Note: Not suitable for TaMas open fronted storage bins C1-6Q/R/S/T</p>		<p>For table width 1200 mm K9-4G.B1200</p> <p>For table width 1500 mm K9-4G.B1500</p> <p>For table width 1600 mm K9-4G.B1600</p> <p>For table width 1800 mm K9-4G.B1800</p> <p>For table width 2000 mm K9-4G.B2000</p>

primus one

Accessories

Technical data

Description		Ordering no.
<p>ELABO multifunction attachment Lighting / Balancer etc. </p> <p>W=976mm, 1276mm, 1376mm, 1576mm, 1776mm D = 450 mm, H = 40 mm</p> <p>For mounting on PrimusOne system profiles K5-1P. The accessory can be mounted on a transversely strut profile screwed.</p>		<p>For table width 1200 mm K9-4L.B1200</p> <p>For table width 1500 mm K9-4L.B1500</p> <p>For table width 1600 mm K9-4L.B1600</p> <p>For table width 1800 mm K9-4L.B1800</p> <p>For table width 2000 mm K9-4L.B2000</p>
<p>TFT traverse</p> <p>W = 976, 1276, 1376, 1576, 1776 mm</p> <p>D = 91mm, H = 23 mm</p> <p>For mounting between the rear system profiles, stepless height adjustment.</p> <p>Profile: - anodized aluminum profile at front and back with grooves; accepts TFT spherical heads P3-5L-2 or support bracket P3-5K-2 - fastening strap on each side to allow infinite height adjustment</p>		<p>For table width 1200 mm K9-4T.B1200</p> <p>For table width 1500 mm K9-4T.B1500</p> <p>For table width 1600 mm K9-4T.B1600</p> <p>For table width 1800 mm K9-4T.B1800</p> <p>For table width 2000 mm K9-4T.B2000</p>
<p>Warning lamp LED red to indicate that the mains voltage has been released</p> <p>Red Red / Green Red / Yellow / Green</p> <p>mounted on Primus One® system profile. Mounting either left or right, Primus Basic profile and table structure wood</p>		<p>red 01-94.L101</p> <p>red/green 01-94.L201</p> <p>red / yellow / green 01-94.L301</p>
<p>Warning lamp mounting kit for mounting of Warning lamp LED 01-94.Lx</p>		<p>Primus One® right 01-94.HP01</p> <p>Primus One® left 01-94.HP02</p> <p>Primus Basic 01-94.HB01</p> <p>wooden structure 01-94.HA01</p>

B primus basic



Table of contents

B1 Tables	83
B2 Instrument Shelves 102	102
B3 System-Channels 3HU	117
B4 Superstructures	121
B5 Accessories Primus Basic	134

Tables

B1

primus basic

System table with cable flap and cable duct



Edge strip



F-edging

Technical features

- Hinged cable flap over the entire table width
- Large-volume cable trough accessible from the front
- When set up side by side the cabling can be passed straight through
- Exchangeable front edging (in configuration F- edging)
- Height adjusters for leveling on uneven floors
- ESD [Electrostatic Discharge] variant for EPA [Electrostatic Protective Area] facilities

Note:

Compatible in row and block formation with Primus One System

Suitable corner sections for corner combinations you can find on [page 26-29](#)



primus basic

System table with cable flap and cable duct

Technical data

Table top	
Thickness	30 mm
Front edging	Edge strip 3 mm thick or Flexi-Line edging, exchangeable (F-edging)
Coating	HPL laminate 0.8 mm, non-glare, abrasion-resistant in accordance with EN 438, heat-resistant for short periods, highly flame-retardant
Colour	light grey RAL 7035
Cable duct	
Dimensions	Height =150 mm, Depth = 165 mm
Cable flap	
Configuration	Hinged, with sealing profile on the back
Load capacity	
Weight loading	500 kg surface load capacity
ESD Variant	
Table top	Same properties as standard model but volume-conductive
Configuration	DIN EN 61340-5-1 Part 5-1
Dimension	
Width	1200 mm, 1500 mm, 1600 mm, 1800 mm, 2000 mm
Depth	800 mm, 900 mm, 1000 mm
Height	750 mm

Ordering no.

Width x Depth	F-edging	F-edging ESD 	Edge strip	Edge strip ESD 
1200 mm x 800 mm	R0-1E	R0-4E	R0-1E.S	R0-4E.S
1500 mm x 800 mm	R0-1D	R0-4D	R0-1D.S	R0-4D.S
1600 mm x 800 mm	R0-1C	R0-4C	R0-1C.S	R0-4C.S
1800 mm x 800 mm	R0-1B	R0-4B	R0-1B.S	R0-4B.S
2000 mm x 800 mm	R0-1A	R0-4A	R0-1A.S	R0-4A.S
1200 mm x 900 mm	R0-2E	R0-5E	R0-2E.S	R0-5E.S
1500 mm x 900 mm	R0-2D	R0-5D	R0-2D.S	R0-5D.S
1600 mm x 900 mm	R0-2C	R0-5C	R0-2C.S	R0-5C.S
1800 mm x 900 mm	R0-2B	R0-5B	R0-2B.S	R0-5B.S
2000 mm x 900 mm	R0-2A	R0-5A	R0-2A.S	R0-5A.S
1200 mm x 1000 mm	R0-3E	R0-6E	R0-3E.S	R0-6E.S
1500 mm x 1000 mm	R0-3D	R0-6D	R0-3D.S	R0-6D.S
1600 mm x 1000 mm	R0-3C	R0-6C	R0-3C.S	R0-6C.S
1800 mm x 1000 mm	R0-3B	R0-6B	R0-3B.S	R0-6B.S
2000 mm x 1000 mm	R0-3A	R0-6A	R0-3A.S	R0-6A.S

primus basic

System table with cable duct



Edge strip



F-edging

Technical features

- Large-volume cable trough accessible from the front
- When set up side by side the cabling can be passed straight through
- Exchangeable front edging (in configuration F- edging)
- Height adjusters for leveling on uneven floors
- ESD [Electrostatic Discharge] variant for EPA [Electrostatic Protective Area] facilities

Note:

Compatible in row and block formation with Primus One System

Suitable corner sections for corner combinations you can find on page 26-29



Attention:

No profile cutouts

Table not expandable upwards. For upward extension configuration with cutout for system profiles is needed

primus basic

System table with cable duct

Technical data

Table top	
Thickness	30 mm
Front edging	Edge strip 3 mm thick or Flexi-Line edging, exchangeable (F-edging)
Coating	HPL laminate 0.8 mm, non-glare, abrasion-resistant in accordance with EN 438, heat-resistant for short periods, highly flame-retardant
Colour	light grey RAL 7035
Cable duct	
Dimensions	Height = 150 mm, Depth = 165 mm
Load capacity	
Weight loading	500 kg surface load capacity
ESD Variant	
Table top	Same properties as standard model but volume-conductive
Configuration	DIN EN 61340-5-1 Part 5-1
Dimensions	
Width	1200 mm, 1500 mm, 1600 mm, 1800 mm, 2000 mm
Depth	800 mm, 900 mm, 1000 mm
Height	750 mm

Ordering no.

Width x Depth	F-edging	F-edging ESD 	Edge strip	Edge strip ESD 
1200 mm x 800 mm	R0-1E.6	R0-4E.6	R0-1E.S6	R0-4E.S6
1500 mm x 800 mm	R0-1D.6	R0-4D.6	R0-1D.S6	R0-4D.S6
1600 mm x 800 mm	R0-1C.6	R0-4C.6	R0-1C.S6	R0-4C.S6
1800 mm x 800 mm	R0-1B.6	R0-4B.6	R0-1B.S6	R0-4B.S6
2000 mm x 800 mm	R0-1A.6	R0-4A.6	R0-1A.S6	R0-4A.S6
1200 mm x 900 mm	R0-2E.6	R0-5E.6	R0-2E.S6	R0-5E.S6
1500 mm x 900 mm	R0-2D.6	R0-5D.6	R0-2D.S6	R0-5D.S6
1600 mm x 900 mm	R0-2C.6	R0-5C.6	R0-2C.S6	R0-5C.S6
1800 mm x 900 mm	R0-2B.6	R0-5B.6	R0-2B.S6	R0-5B.S6
2000 mm x 900 mm	R0-2A.6	R0-5A.6	R0-2A.S6	R0-5A.S6
1200 mm x 1000 mm	R0-3E.6	R0-6E.6	R0-3E.S6	R0-6E.S6
1500 mm x 1000 mm	R0-3D.6	R0-6D.6	R0-3D.S6	R0-6D.S6
1600 mm x 1000 mm	R0-3C.6	R0-6C.6	R0-3C.S6	R0-6C.S6
1800 mm x 1000 mm	R0-3B.6	R0-6B.6	R0-3B.S6	R0-6B.S6
2000 mm x 1000 mm	R0-3A.6	R0-6A.6	R0-3A.S6	R0-6A.S6

primus basic

System table



Edge strip



F-edging

Technical features

- Exchangeable front edging (in configuration F- edging)
- Height adjusters for leveling on uneven floors
- ESD [Electrostatic Discharge] variant for EPA [Electrostatic Protective Area] facilities

Note:

Compatible in row and block formation with Primus One System

Suitable corner sections for corner combinations you can find on page 26-29



Attention:

No profile cutouts

Table not expandable upwards. For upward extension configuration with cutout for system profiles is needed

primus basic

System table

Technical data

Table top	
Thickness	30 mm
Front edging	Edge strip 3 mm thick or Flexi-Line edging, exchangeable (F-edging)
Coating	HPL laminate 0.8 mm, non-glare, abrasion-resistant in accordance with EN 438, heat-resistant for short periods, highly flame-retardant
Colour	light grey RAL 7035
Load capacity	
Weight loading	500 kg surface load capacity
ESD Variant	
Table top	Same properties as standard model but volume-conductive
Configuration	DIN EN 61340-5-1 Part 5-1
Dimensions	
Width	1200 mm, 1500 mm, 1600 mm, 1800 mm, 2000 mm
Depth	800 mm, 900 mm, 1000 mm
Height	750 mm

Ordering no.

Width x Depth	F-edging	F-edging ESD 	Edge strip	Edge strip ESD 
1200 mm x 800 mm	R0-1E.4	R0-4E.4	R0-1E.S4	R0-4E.S4
1500 mm x 800 mm	R0-1D.4	R0-4D.4	R0-1D.S4	R0-4D.S4
1600 mm x 800 mm	R0-1C.4	R0-4C.4	R0-1C.S4	R0-4C.S4
1800 mm x 800 mm	R0-1B.4	R0-4B.4	R0-1B.S4	R0-4B.S4
2000 mm x 800 mm	R0-1A.4	R0-4A.4	R0-1A.S4	R0-4A.S4
1200 mm x 900 mm	R0-2E.4	R0-5E.4	R0-2E.S4	R0-5E.S4
1500 mm x 900 mm	R0-2D.4	R0-5D.4	R0-2D.S4	R0-5D.S4
1600 mm x 900 mm	R0-2C.4	R0-5C.4	R0-2C.S4	R0-5C.S4
1800 mm x 900 mm	R0-2B.4	R0-5B.4	R0-2B.S4	R0-5B.S4
2000 mm x 900 mm	R0-2A.4	R0-5A.4	R0-2A.S4	R0-5A.S4
1200 mm x 1000 mm	R0-3E.4	R0-6E.4	R0-3E.S4	R0-6E.S4
1500 mm x 1000 mm	R0-3D.4	R0-6D.4	R0-3D.S4	R0-6D.S4
1600 mm x 1000 mm	R0-3C.4	R0-6C.4	R0-3C.S4	R0-6C.S4
1800 mm x 1000 mm	R0-3B.4	R0-6B.4	R0-3B.S4	R0-6B.S4
2000 mm x 1000 mm	R0-3A.4	R0-6A.4	R0-3A.S4	R0-6A.S4

primus basic

System table without cable flap, with cutout for system profiles



Technical features

- Exchangeable front edging (in configuration F- edging)
- Height adjusters for leveling on uneven floors
- When set up side by side the cabling can be passed straight through
- ESD [Electrostatic Discharge] variant for EPA [Electrostatic Protective Area] facilities
- Large-volume cable trough accessible from the front

Note:

Compatible in row and block formation with Primus One System

Suitable corner sections for corner combinations you can find on page 26-29



primus basic

System table without cable flap, with cutout for system profiles

Technical data

Table top	
Thickness	30 mm
Front edging	Edge strip 3 mm thick or Flexi-Line edging, exchangeable (F-edging)
Coating	HPL laminate 0.8 mm, non-glare, abrasion-resistant in accordance with EN 438, heat-resistant for short periods, highly flame-retardant
Colour	light grey RAL 7035
Load capacity	
Weight loading	500 kg surface load capacity
ESD Variant	
Table top	Same properties as standard model but volume-conductive
Configuration	DIN EN 61340-5-1 Part 5-1
Dimensions	
Width	1200 mm, 1500 mm, 1600 mm, 1800 mm, 2000 mm
Depth	800 mm, 900 mm, 1000 mm
Height	750 mm

Cable duct

Dimensions	
Depth	165 mm
Height	150 mm

Ordering no.

Width x Depth	F-edging	F-edging ESD 	Edge strip	Edge strip ESD 
1200 mm x 800 mm	R0-1E.2	R0-4E.2	R0-1E.S2	R0-4E.S2
1500 mm x 800 mm	R0-1D.2	R0-4D.2	R0-1D.S2	R0-4D.S2
1600 mm x 800 mm	R0-1C.2	R0-4C.2	R0-1C.S2	R0-4C.S2
1800 mm x 800 mm	R0-1B.2	R0-4B.2	R0-1B.S2	R0-4B.S2
2000 mm x 800 mm	R0-1A.2	R0-4A.2	R0-1A.S2	R0-4A.S2
1200 mm x 900 mm	R0-2E.2	R0-5E.2	R0-2E.S2	R0-5E.S2
1500 mm x 900 mm	R0-2D.2	R0-5D.2	R0-2D.S2	R0-5D.S2
1600 mm x 900 mm	R0-2C.2	R0-5C.2	R0-2C.S2	R0-5C.S2
1800 mm x 900 mm	R0-2B.2	R0-5B.2	R0-2B.S2	R0-5B.S2
2000 mm x 900 mm	R0-2A.2	R0-5A.2	R0-2A.S2	R0-5A.S2
1200 mm x 1000 mm	R0-3E.2	R0-6E.2	R0-3E.S2	R0-6E.S2
1500 mm x 1000 mm	R0-3D.2	R0-6D.2	R0-3D.S2	R0-6D.S2
1600 mm x 1000 mm	R0-3C.2	R0-6C.2	R0-3C.S2	R0-6C.S2
1800 mm x 1000 mm	R0-3B.2	R0-6B.2	R0-3B.S2	R0-6B.S2
2000 mm x 1000 mm	R0-3A.2	R0-6A.2	R0-3A.S2	R0-6A.S2

primus basic

System table without cable flap, without cable duct, with cutout for system profiles



Technical features

- Exchangeable front edging (in configuration F-edging)
- Height adjusters for leveling on uneven floors
- ESD [Electrostatic Discharge] variant for EPA [Electrostatic Protective Area] facilities

Note:

Compatible in row and block formation with Primus One System

Suitable corner sections for corner combinations you can find on page 26-29





primus basic

System table without cable flap, without cable duct, with cutout for system profiles

Technical data

Table top	
Thickness	30 mm
Front edging	Edge strip 3 mm thick or Flexi-Line edging, exchangeable (F-edging)
Coating	HPL laminate 0.8 mm, non-glare, abrasion-resistant in accordance with EN 438, heat-resistant for short periods, highly flame-retardant
Colour	light grey RAL 7035
Load capacity	
Weight loading	500 kg surface load capacity
ESD Variant	
Table top	Same properties as standard model but volume-conductive
Configuration	DIN EN 61340-5-1 Part 5-1
Dimensions	
Width	1200 mm, 1500 mm, 1600 mm, 1800 mm, 2000 mm
Depth	800 mm, 900 mm, 1000 mm
Height	750 mm

Ordering no.

Width x Depth	F-edging	F-edging ESD 	Edge strip	Edge strip ESD 
1200 mm x 800 mm	R0-1E.1	R0-4E.1	R0-1E.S1	R0-4E.S1
1500 mm x 800 mm	R0-1D.1	R0-4D.1	R0-1D.S1	R0-4D.S1
1600 mm x 800 mm	R0-1C.1	R0-4C.1	R0-1C.S1	R0-4C.S1
1800 mm x 800 mm	R0-1B.1	R0-4B.1	R0-1B.S1	R0-4B.S1
2000 mm x 800 mm	R0-1A.1	R0-4A.1	R0-1A.S1	R0-4A.S1
1200 mm x 900 mm	R0-2E.1	R0-5E.1	R0-2E.S1	R0-5E.S1
1500 mm x 900 mm	R0-2D.1	R0-5D.1	R0-2D.S1	R0-5D.S1
1600 mm x 900 mm	R0-2C.1	R0-5C.1	R0-2C.S1	R0-5C.S1
1800 mm x 900 mm	R0-2B.1	R0-5B.1	R0-2B.S1	R0-5B.S1
2000 mm x 900 mm	R0-2A.1	R0-5A.1	R0-2A.S1	R0-5A.S1
1200 mm x 1000 mm	R0-3E.1	R0-6E.1	R0-3E.S1	R0-6E.S1
1500 mm x 1000 mm	R0-3D.1	R0-6D.1	R0-3D.S1	R0-6D.S1
1600 mm x 1000 mm	R0-3C.1	R0-6C.1	R0-3C.S1	R0-6C.S1
1800 mm x 1000 mm	R0-3B.1	R0-6B.1	R0-3B.S1	R0-6B.S1
2000 mm x 1000 mm	R0-3A.1	R0-6A.1	R0-3A.S1	R0-6A.S1

primus basic

System table with Multitplex table top, flap and cable duct



Edge strip



F-Edging

Technical features

- Robust and resistant multitplex table top
- Hinged cable flap over the entire table width
- Large-volume cable trough accessible from the front
- When set up side by side the cabling can be passed straight through
- Exchangeable front edging (in configuration F- edging)
- Height adjusters for leveling on uneven floors
- ESD [Electrostatic Discharge] variant for EPA [Electrostatic Protective Area] facilities

Note:

Compatible in row and block formation with Primus One® System

Suitable corner sections for corner combinations you can find on page 26-29

primus basic

System table with granite plate

Technical data

Table top	
Thickness	30 mm
Front edging	Sanded and painted
Coating	Surface sanded over and painted colorless
Load capacity	
Weight loading	500 kg surface load capacity
Load capacity	
Dimensions	W = 150mm, D = 165 mm
Cable flap	
Configuration	Hinged, with sealing profile on the back
Dimensions	
Width	1200 mm, 1500 mm, 1600 mm, 1800 mm, 2000 mm
Depth	800 mm, 900 mm, 1000 mm
Height	750 mm

Cabel duct

Dimensions	
Width	1200 mm, 1500 mm, 1600 mm, 1800 mm, 2000 mm
Depth	800 mm, 900 mm, 1000 mm
Height	750 mm

Ordering no.

Width x Depth	Edge strip	F-edging
1200 mm x 800 mm	R0-1E.SMU	R0-1E.MU
1500 mm x 800 mm	R0-1D.SMU	R0-1D.MU
1600 mm x 800 mm	R0-1C.SMU	R0-1C.MU
1800 mm x 800 mm	R0-1B.SMU	R0-1B.MU
2000 mm x 800 mm	R0-1A.SMU	R0-1A.MU
1200 mm x 900 mm	R0-2E.SMU	R0-2E.MU
1500 mm x 900 mm	R0-2D.SMU	R0-2D.MU
1600 mm x 900 mm	R0-2C.SMU	R0-2C.MU
1800 mm x 900 mm	R0-2B.SMU	R0-2B.MU
2000 mm x 900 mm	R0-2A.SMU	R0-2A.MU
1200 mm x 1000 mm	R0-3E.SMU	R0-3E.MU
1500 mm x 1000 mm	R0-3D.SMU	R0-3D.MU
1600 mm x 1000 mm	R0-3C.SMU	R0-3C.MU
1800 mm x 1000 mm	R0-3B.SMU	R0-3B.MU
2000 mm x 1000 mm	R0-3A.SMU	R0-3A.MU

primus basic

System table with granite plate

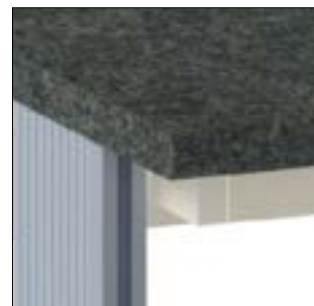

Technical features

- Heat resistant table top made of granite
- Scratchproof, stain resist and abrasion resistant countertop
- Height adjusters for leveling on uneven floors
- Large-volume cable trough accessible from the front
- Hinged cable flap over the entire table width

Note:

Compatible in row and block formation with Primus One® System

primus basic

System table with granite plate

Technical data

Table top	
Thickness	30 mm
Front edging	Polished
granite type	Nero Impala
Colour	Black graying
Coating	HPL laminate 0.8 mm, non-glare, abrasion-resistant in accordance with EN 438, heat-resistant for short periods, highly flame-retardant
Colour Cable duct	light grey RAL 7035
Load capacity	
Weight loading	200 kg surface load capacity
ESD Variant	
Table top	Same properties as standard model but volume-conductive
Configuration	DIN EN 61340-5-1 Part 5-1
Dimensions	
Width	1200 mm, 1500 mm, 1600 mm, 1800 mm, 2000 mm
Depth	800 mm, 900 mm, 1000 mm
Height	750 mm

Cabel duct

Dimensions	
Width	1200 mm, 1500 mm, 1600 mm, 1800 mm, 2000 mm
Depth	800 mm, 900 mm, 1000 mm
Height	750 mm

Ordering no.

Width x Depth	
1200 mm x 800 mm	R0-1E.G
1500 mm x 800 mm	R0-1D.G
1600 mm x 800 mm	R0-1C.G
1800 mm x 800 mm	R0-1B.G
2000 mm x 800 mm	R0-1A.G
1200 mm x 900 mm	R0-2E.G
1500 mm x 900 mm	R0-2D.G
1600 mm x 900 mm	R0-2C.G
1800 mm x 900 mm	R0-2B.G
2000 mm x 900 mm	R0-2A.G
1200 mm x 1000 mm	R0-3E.G
1500 mm x 1000 mm	R0-3D.G
1600 mm x 1000 mm	R0-3C.G
1800 mm x 1000 mm	R0-3B.G
2000 mm x 1000 mm	R0-3A.G

primus basic

System table height-adjustable by electric motor



Edge strip



F-edging

Technical features

- Large-volume cable trough accessible from the front
- Hinged cable flap over the entire table width
- When set up side by side the cabling can be passed straight through
- Exchangeable front edging
- Height adjusters for leveling on uneven floors
- Electrohydraulic height adjustment
- Programmable minimum and maximum height(s)
- ESD [Electrostatic Discharge] variant for EPA [Electrostatic Protective Area] facilities
- Lift capacity 1600N per column
- Travel speed 9 mm / s
- Shortening of the table legs for corner installation is possible.

primus basic

System table height-adjustable by electric motor

Technical data

Table top	
Thickness	30 mm
Front edging	Edge strip 3 mm thick or Flexi-Line edging, exchangeable (F-edging)
Coating	HPL laminate 0.8 mm, non-glare, abrasion-resistant in accordance with EN 438, heat-resistant for short periods, highly flame-retardant
Colour	light grey RAL 7035
Cable duct	
Dimensions	Height =150 mm, Depth = 175 mm
Cable flap	
Configuration	Hinged, with sealing profile on the back
Load capacity	
Weight loading	200 kg surface load capacity
ESD Variant	
Table top	Same properties as standard model but volume-conductive
Configuration	DIN EN 61340-5-1 Part 5-1
Dimensions	
Width	1200 mm, 1500 mm, 1600 mm, 1800 mm, 2000 mm
Depth	800 mm, 900 mm, 1000 mm
Height	E = Electrically from 750 mm to 1200 mm



Ordering no.

Width x Depth	F-edging	F-edging ESD 	Edge strip	Edge strip ESD 
1200 mm x 800 mm	R0-1E.EC	R0-4E.EC	R0-1E.SEC	R0-4E.SEC
1500 mm x 800 mm	R0-1D.EC	R0-4D.EC	R0-1D.SEC	R0-4D.SEC
1600 mm x 800 mm	R0-1C.EC	R0-4C.EC	R0-1C.SEC	R0-4C.SEC
1800 mm x 800 mm	R0-1B.EC	R0-4B.EC	R0-1B.SEC	R0-4B.SEC
2000 mm x 800 mm	R0-1A.EC	R0-4A.EC	R0-1A.SEC	R0-4A.SEC
1200 mm x 900 mm	R0-2E.EC	R0-5E.EC	R0-2E.SEC	R0-5E.SEC
1500 mm x 900 mm	R0-2D.EC	R0-5D.EC	R0-2D.SEC	R0-5D.SEC
1600 mm x 900 mm	R0-2C.EC	R0-5C.EC	R0-2C.SEC	R0-5C.SEC
1800 mm x 900 mm	R0-2B.EC	R0-5B.EC	R0-2B.SEC	R0-5B.SEC
2000 mm x 900 mm	R0-2A.EC	R0-5A.EC	R0-2A.SEC	R0-5A.SEC
1200 mm x 1000 mm	R0-3E.EC	R0-6E.EC	R0-3E.SEC	R0-6E.SEC
1500 mm x 1000 mm	R0-3D.EC	R0-6D.EC	R0-3D.SEC	R0-6D.SEC
1600 mm x 1000 mm	R0-3C.EC	R0-6C.EC	R0-3C.SEC	R0-6C.SEC
1800 mm x 1000 mm	R0-3B.EC	R0-6B.EC	R0-3B.SEC	R0-6B.SEC
2000 mm x 1000 mm	R0-3A.EC	R0-6A.EC	R0-3A.SEC	R0-6A.SEC

primus basic

Accessories System table height-adjustable by electric motor

Technical data

Description		Order-no.
<p>Manuel switch for Syncontrol control.</p> <p>Functions:</p> <ul style="list-style-type: none"> - UP/Down - with digital display for table height 		K9-0M.ECL_20
<p>Manuel switch for Syncontrol</p> <p>Functions:</p> <ul style="list-style-type: none"> -UP / Down - with digital display for table height - 4-fold memory 		K9-0M.ECL_01
<p>Extension cable RJ12</p> <p>suitable for table control .EC system tables Plug/ socket RJ12, length 2,5 m</p>		K9-0M.ECL_02
<p>Synchronous operation to connect electromotive height-adjustable Primus One an Primus Basic System tables</p> <p>Synchronous operation of 2 workstations</p> <p>Synchronous operation of 3 workstations</p> <p>Synchronous operation of 4 workstations</p>		<p>K9-0M.ECL_10</p> <p>K9-0M.ECL_11</p> <p>K9-0M.ECL_12</p>

primus basic

Accessories System table height-adjustable by electric motor

Technical data

Description		Order-no.
<p>Energie chain</p> <p>Can be used for the Systems Primus Basic and Primus One®.</p> <p>for floor outlet mounted: Cable tray to skid</p> <p>for row installation mounted: Cable tray to cable tray</p> <p>for wall mounting mounted: Cable tray to parapet trunking</p> <p>for ceiling mounting max. length 1800 mm mounted: upper edge profile to ceiling</p>		<p>K9-0E</p> <p>K9-0E.X01</p> <p>K9-0E.X02</p> <p>K9-0E.X03</p>
<p>Vertical channel for system insert panels W = 330 mm</p> <p>Can be used for the Systems Primus Basic and Primus One®.</p>		<p>K5-1P.0330-EC</p>

Instrument Shelves

B2

Instrument Shelves

B2

primus basic

System-Shelf element



Technical features

- Shelf element made of 30 mm HPL coated board
- LED lighting can be integrated
- Orga panel can be integrated
- ESD [Electrostatic Discharge] variant for EPA [Electrostatic Protective Area] facilities

Note:

Inclusive system carrier

Orga panel available separately

primus basic

System-Shelf element

Technical data

Shelf panel	
Thickness	30 mm
Coating	Melamine coating, resistant to organic solvents, weak acids, gasoline and oil
Colour	light grey RAL 7035
Load capacity	
Weight loading	100 kg surface load capacity
ESD Variant	
Table top	Same properties as standard model but volume-conductive
Configuration	DIN EN 61340-5-1 Part 5-1
Dimensions	
Width shelf element	1128 mm, 1428 mm, 1528 mm, 1728 mm, 1928 mm
Depth	400 mm
Height	30 mm (+60 mm system carrier)

Ordering no.

Width / for table width	Standard (including system carrier)	ESD (including system carrier) 
1128 mm / 1200 mm	R4-7E	R4-7L
1428 mm / 1500 mm	R4-7D	R4-7K
1528 mm / 1600 mm	R4-7C	R4-7J
1728 mm / 1800 mm	R4-7B	R4-7H
1928 mm / 2000 mm	R4-7A	R4-7G

Suitable system profile (1 pair)

Lenght: 570 mm	R5-1P.0570
----------------	------------

Suitable vertical cable duct

2-fold, Width / Height 30 mm x 30 mm Lenght 570 mm for system profile Lenght 730 mm for table leg	R5-1K.0570
---	------------

primus basic

System Corner system shelf element



Technical features

- System shelf element made of 30 mm HPL coated board, front edging rounded
- Shelf will be fixed between the system profiles of the tables
- ESD [Electrostatic Discharge] variant for EPA [Electrostatic Protective Area] facilities

Note:

Including cross carrier

Identical to Primus One®

primus basic

System Corner system shelf element

Technical data

Shelf panel	
Thickness	30 mm
Coating	Melamine coating, resistant to organic solvents, weak acids, gasoline and oil
Colour	light grey RAL 7035
ESD Variant	
Table top	Same properties as standard model but volume-conductiv
Configuration	DIN EN 61340-5-1 Part 5-1
Dimensions	
Width / Equipment	For corner table top, 55 mm edge or CAD table top, 600 mm edge
Depth	800 mm, 900 mm, 1000 mm
Height	Shelf: 30 mm (+40 mm cross carrier)

Ordering-no.

Width / for table width	Standard (including cross carrier)	ESD (including cross carrier) 
800 mm / 55 mm	R4-7N.E	R4-7N.E_ESD
900 mm / 55 mm	R4-7P.E	R4-7P.E_ESD
1000 mm / 55 mm	R4-7Q.E	R4-7Q.E_ESD
800 mm / 600 mm	R4-7N.F	R4-7N.F_ESD
900 mm / 600 mm	R4-7P.F	R4-7P.F_ESD
1000 mm / 600 mm	R4-7Q.F	R4-7Q.F_ESD

primus basic

Corner shelf element



Technical features

- Shelf element made of 30 mm HPL coated board
- Function shelf has slide-prevention edging at the front and the back
- Stepless height adjustment
- ESD [Electrostatic Discharge] variant for EPA [Electrostatic Protective Area] facilities
- Two heavy-duty grooves are provided, one at the top and one at the bottom

Note:

Identical to Primus One®

primus basic

Corner shelf element

Technical data

Shelf panel	
Thickness	19 mm
Coating	Melamine coating, resistant to organic solvents, weak acids, gasoline and oil
Colour	light grey RAL 7035
ESD Variant	
Table top	Same properties as standard model but volume-conductive
Configuration	DIN EN 61340-5-1 Part 5-1
Dimensions	
Width function shelf	For corner table tops 55 mm or CAD table tops 600 mm edge
Depth	800 mm, 900 mm, 1000 mm
Height	88 mm

Ordering no.

Width / for table deoth	Standard	ESD 
800 mm / 55 mm	K4-3N.E	K4-3N.E_ESD
900 mm / 55 mm	K4-3P.E	K4-3P.E_ESD
1000 mm / 55 mm	K4-3Q.E	K4-3Q.E_ESD
800 mm / 600 mm	K4-3N.F	K4-3F.E_ESD
900 mm / 600 mm	K4-3P.F	K4-3P.F_ESD
1000 mm / 600 mm	K4-3Q.F	K4-3Q.F_ESD

primus basic

System function shelf



Technical features

- Function shelf can be steplessly tilted by 30°
- Function shelf has slide-prevention edging at the front and the back
- Stepless height adjustment
- ESD [Electrostatic Discharge] variant for EPA [Electrostatic Protective Area] facilities
- Two heavy-duty grooves are provided, one at the top and one at the bottom



primus basic

System function shelf

Technical data

Shelf panel	
Thickness	19 mm
Coating	Melamine coating, resistant to organic solvents, weak acids, gasoline and oil
Colour	light grey RAL 7035
Load capacity	
Weight loading	80 kg surface load capacity up to 1600 mm width 60 kg surface load capacity up to 2000 mm width
ESD Variant	
Table top	Same properties as standard model but volume-conductive
Configuration	DIN EN 61340-5-1 Part 5-1
Dimensions	
Width function shelf	1128 mm, 1428 mm, 1528 mm, 1728 mm, 1928 mm
Depth	400 mm
Height	88 mm

Ordering no.

Width / for table width	Standard	ESD 
1128 mm / 1200 mm	R4-3E	R4-3L
1428 mm / 1500 mm	R4-3D	R4-3K
1528 mm / 1600 mm	R4-3C	R4-3J
1728 mm / 1800 mm	R4-3B	R4-3H
1928 mm / 2000 mm	R4-3A	R4-3G

Suitable accessories

Function tray	for table width	Height	Depth	Ordering no. 
	1200 mm	83 mm	90 mm	R9-4K.B1200
	1500 mm	83 mm	90 mm	R9-4K.B1500
	1600 mm	83 mm	90 mm	R9-4K.B1600
	1800 mm	83 mm	90 mm	R9-4K.B1800
	2000 mm	83 mm	90 mm	R9-4K.B2000

primus basic

3HU-System-Instrument shelf partially equipped



Technical features

- Shelf element made of 30 mm HPL coated board
- Storage area for customer's own measuring devices and power supplies
- Possibility of equipping with Elabo components
- LED lighting can be integrated
- Orga panel can be integrated
- ESD [Electrostatic Discharge] variant for EPA [Electrostatic Protective Area] facilities



Note:

Including system carrier

Orga panel available separately

primus basic

3HU-System-Instrument shelf partially equipped

Technical data

Shelf panel			
Thickness	30 mm		
Coating	Melamine coating, resistant to organic solvents, weak acids, gasoline and oil		
Colour	light grey RAL 7035		
ESD Variant			
Table top	Same properties as standard model but volume-conductive		
Configuration	DIN EN 61340-5-1 Part 5-1		
Dimensions	Width	Mounting Width	Storage Area
Width / Equipment	1128 mm	114HP	465 mm
	1428 mm	114HP	765 mm
	1528 mm	168HP	590 mm
	1728 mm	168HP	790 mm
	1928 mm	168HP	990 mm
Depth	400 mm		
Height	Shelf: 30 mm (+60 mm system carrier) Bench rack: 180 mm (+60 mm system carrier)		

Ordering no. Bench rack left

Width / for table width	Standard (including system carrier)	ESD (including system carrier) 
1128 mm / 1200 mm	R4-7E.3HU	R4-7L.3HU
1428 mm / 1500 mm	R4-7D.3HU	R4-7K.3HU
1528 mm / 1600 mm	R4-7C.3HU	R4-7J.3HU
1728 mm / 1800 mm	R4-7B.3HU	R4-7H.3HU
1928 mm / 2000 mm	R4-7A.3HU	R4-7G.3HU

Ordering no. Bench rack right

Width / for table width	Standard (including system carrier)	ESD (including system carrier) 
1128 mm / 1200 mm	R4-7E.3HU-RE	R4-7L.3HU-RE
1428 mm / 1500 mm	R4-7D.3HU-RE	R4-7K.3HU-RE
1528 mm / 1600 mm	R4-7C.3HU-RE	R4-7J.3HU-RE
1728 mm / 1800 mm	R4-7B.3HU-RE	R4-7H.3HU-RE
1928 mm / 2000 mm	R4-7A.3HU-RE	R4-7G.3HU-RE

Suitable system profile (1 pair)

Lenght: 570/720 mm	R5-1P.0570_0720
--------------------	-----------------

Suitable vertical cable duct

2-fold, Width / Height 30 mm x 30 mm Lenght 570 mm for system profile Lenght 730 mm for table leg	R5-1K.0570
---	------------

primus basic

6HU System-Instrument shelf partially equipped



Technical features

- Storage area for customer's own measuring devices and power supplies
- Possibility of equipping with Elabo components
- LED lighting can be integrated
- Orga panel can be integrated for shelf element
- Shelf element prepared on each side for downward routing of cable
- ESD [Electrostatic Discharge] variant for EPA [Electrostatic Protective Area] facilities



Note:

Including system carrier

Orga panel available separately

primus basic

6HU System-Instrument shelf partially equipped

Technical data

Shelf panel			
Thickness	30 mm		
Coating	Melamine coating, resistant to organic solvents, weak acids, gasoline and oil		
Colour	light grey RAL 7035		
ESD Variant			
Table top	Same properties as standard model but volume-conductive		
Configuration	DIN EN 61340-5-1 Part 5-1		
Dimensions	Width	Mounting Width	Storage Area
Width / Equipment	1128 mm	114HP	465 mm
	1428 mm	114HP	765 mm
	1528 mm	168HP	590 mm
	1728 mm	168HP	790 mm
	1928 mm	168HP	990 mm
Depth	400 mm		
Height	Shelf: 30 mm (+60 mm system carrier) Bench rack: 180 mm (+60 mm system carrier)		

Ordering no. Bench rack left

Width / for table width	Standard (including system carrier)	ESD (including system carrier) 
1128 mm / 1200 mm	R4-7E.6HU	R4-7L.6HU
1428 mm / 1500 mm	R4-7D.6HU	R4-7K.6HU
1528 mm / 1600 mm	R4-7C.6HU	R4-7J.6HU
1728 mm / 1800 mm	R4-7B.6HU	R4-7H.6HU
1928 mm / 2000 mm	R4-7A.6HU	R4-7G.6HU

Ordering no. Bench rack right

Width / for table width	Standard (including system carrier)	ESD (including system carrier) 
1128 mm / 1200 mm	R4-7E.6HU-RE	R4-7L.6HU-RE
1428 mm / 1500 mm	R4-7D.6HU-RE	R4-7K.6HU-RE
1528 mm / 1600 mm	R4-7C.6HU-RE	R4-7J.6HU-RE
1728 mm / 1800 mm	R4-7B.6HU-RE	R4-7H.6HU-RE
1928 mm / 2000 mm	R4-7A.6HU-RE	R4-7G.6HU-RE

Suitable system profile (1 pair)

Lenght: 570/875 mm	R5-1P.0570_0875
--------------------	-----------------

Suitable vertical cable duct

2-fold, Width / Height 30 mm x 30 mm Lenght 570 mm for system profile Lenght 730 mm for table leg	R5-1K.0570
---	------------

B primus basic



System-Channels 3HU

B3

primus basic

System-Channel



Technical features

- Completely electrically pre-wired with device connections
- Can be fitted with Elabo devices or third-party devices
- Retrofittable LED lighting
- Suitable for EPA facilities
- Two heavy-duty grooves are provided, one at the top and one at the bottom

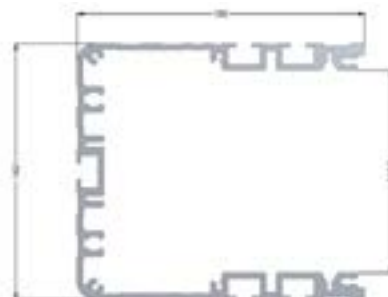

Note:

For lateral cable routing a vertical cable duct is necessary.

primus basic

System-Channel

Technical data

System-Channel		
Material	Aluminium	
Coating	Melamine coating, conductive	
Colour	light grey RAL 7035	
ESD Variant		
Configuration	DIN EN 61340-5-1 Part 5-1	
Dimensions	Width	Equipment
Width	1128 mm	216HP
	1428 mm	276HP
	1528 mm	294HP
	1728 mm	332HP
	1928 mm	372HP
Depth		160 mm
Height	3HU	142 mm

Ordering no.

Width / for table width	ESD 
1928 mm / 1200 mm	R4-1E.SP
1728 mm / 1500 mm	R4-1D.SP
1528 mm / 1600 mm	R4-1C.SP
1428 mm / 1800 mm	R4-1B.SP
1128 mm / 2000 mm	R4-1A.SP

Suitable system profile (1 pair)

Lenght: 712 mm	R5-1P.0712
----------------	------------

Suitable vertical Cable duct

2-fold, Width / Height 30 mm x 30 mm Lenght 712 mm for System profile Lenght 730 mm for table leg	R5-1K.0712
---	------------

B primus basic



Superstructures

B4

primus basic

System-Superstructure



Technical features

- Space-saving power supply systems
- Light grey coated supply channel
- Installation of simple power supply systems
- Already prepared with a 3-phase wiring, the supply channel can be equipped immediately
- The duct is fastened to the tabletop
- Cable outlets at the side and underneath allow simple cable routing
- In order to equip the ducts, you can use the System 3HU power supply panels
- The desktop rack widths are determined acc. DIN 41494 in HP = horizontal pitch = 5.08 mm; this means that the holding capacity is for 3HU built-in components. The installation height is uniform 3HU (1HU = unit of Height = 44.45 mm).



primus basic

System-Superstructure

Technical data

Description			Order-No.
<p>Power supply duct System 3HU</p> <p>For holding 388HP For holding 348HP For holding 308HP For holding 288HP For holding 228HP</p> <p>D = 160 mm; H = 142 mm</p> <p>Cover strips, suitable for groove width 8.4 mm. Colour: silver grey. Customer can cut to size for the appropriate duct width</p> <p>W = 2000 mm, D = 9 mm, H = 7 mm</p>		<p>W = 2000 mm W = 1800 mm W = 1600 mm W = 1500 mm W = 1200 mm</p>	<p>40-4Y 40-4A 40-4D 40-4B 40-4C</p> <p>81-6N</p>
<p>Column rack 3HU</p> <p>For training areas near to experimenting walls or as a space-saving alternative in the laboratory and the workshop</p> <p>3HU, 4 x 60HP</p> <p>W = 353 mm, D = 320 mm, H = 569 mm</p>			<p>R4-0K</p>
<p>Desktop rack Basic 6HU</p> <p>for directly mounting tabletop (without systemcarrier), Inclination angle of 4.5 ° to the rear</p> <p>272 TE 8 mains connectors 330 TE 7 mains connectors 294 TE 7 mains connectors 270 TE 6 mains connectors 216 TE 5 mains connectors</p> <p>D = 375/400 mm, H = 360 mm</p>		<p>W = 2000 mm W = 1800 mm W = 1600 mm W = 1500 mm W = 1200 mm</p>	<p>R4-4A.X03 R4-4B.X03 R4-4C.X03 R4-4D.X03 R4-4E.X03</p>

Assembly example:

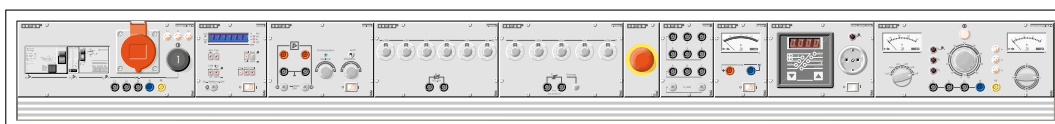
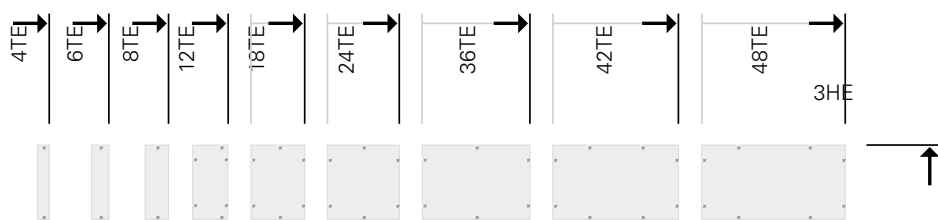

primus basic

System-Bench rack 3HU



Technical features

- Completely electrically pre-wired with device connections
- Can be fitted with Elabo devices or third-party devices
- Retrofittable LED lighting
- Retrofittable Orga panel
- ESD [Electrostatic Discharge] variant for EPA [Electrostatic Protective Area] facilities



Note:
Including system carrier
Orga panel available separately

primus basic

System-Bench rack 3HU

Technical data

Body		
Thickness	19 mm	
Coating	Melamine coating, resistant to organic solvents, weak acids, gasoline and oil	
Colour	light grey RAL 7035	
ESD Variant		
Configuration	DIN EN 61340-5-1 Part 5-1 Body volume-conductive	
Dimensions	Width	Equipment
Width	1128 mm	210HP
	1428 mm	270HP
	1528 mm	288HP
	1728 mm	330HP
	1928 mm	372HP
Depth	350 mm	
Height	3HU	171 mm (231 mm including system carrier)

Ordering no.

Width / for table width	Standard (including system carrier)	ESD (including system carrier) 
1128 mm / 1200 mm	R4-2E	R4-2L
1428 mm / 1500 mm	R4-2D	R4-2K
1528 mm / 1600 mm	R4-2C	R4-2J
1728 mm / 1800 mm	R4-2B	R4-2H
1928 mm / 2000 mm	R4-2A	R4-2G

Suitable system profile (1 pair)

Lenght: 712 mm	R5-1P.0712
----------------	------------

Suitable vertical cable duct

2-fold, Width / Height 30 mm x 30 mm Lenght 712 mm for system profile Lenght 730 mm for table leg	R5-1K.0712
---	------------

primus basic

System-Bench rack 6HU



Technical features

- Completely electrically pre-wired with device connections
- Can be fitted with Elabo devices or third-party devices
- Seamless installation of 19" devices
- Retrofittable LED lighting
- Retrofittable Orga panel
- ESD [Electrostatic Discharge] variant for EPA [Electrostatic Protective Area] facilities



Note:
Including system carrier
Orga panel available separately

primus basic

System-Bench rack 6HU

Technical data

Body		
Thickness	19 mm	
Coating	Melamine coating, resistant to organic solvents, weak acids, gasoline and oil	
Colour	light grey RAL 7035	
ESD Variant		
Configuration	DIN EN 61340-5-1 Part 5-1 Body volume-conductive	
Dimensions	Width	Equipment
Width	1128 mm	210HP
	1428 mm	270HP
	1528 mm	288HP
	1728 mm	330HP
	1928 mm	372HP
Depth		375 mm
Height	6HU	370 mm (430 mm including system carrier)

Ordering no.

Width / for table width	Standard (including system carrier)	ESD (including system carrier) 
1128 mm / 1200 mm	R4-4E	R4-4L
1428 mm / 1500 mm	R4-4D	R4-4K
1528 mm / 1600 mm	R4-4C	R4-4J
1728 mm / 1800 mm	R4-4B	R4-4H
1928 mm / 2000 mm	R4-4A	R4-4G

Suitable system profile (1 pair)

Lenght: 910 mm	R5-1P.0910
----------------	------------

Suitable accessories

Primus One 19" adaption for installation of 19" front panels and inserts. Consisting of: 2x 6HU screen angles, 2x guide rails, 2x front covers, small parts.	K9-4A
--	-------

Suitable vertical cable duct

2-fold, Width / Height 30 mm x 30 mm Lenght 910 mm for system profile Lenght 730 mm for table leg	R5-1K.0910
---	------------

primus basic

System-Shelf Bench rack



Technical features

- Storage space directly at the workplace
- Suitable for DIN A4 file
- Shelf version including one height-adjustable shelf
- Retrofittable LED lighting
- Retrofittable Orga panel
- ESD [Electrostatic Discharge] variant for EPA [Electrostatic Protective Area] facilities

Note:

Including system carrier

Orga panel available separately

primus basic

System-Shelf Bench rack

Technical data

Body	
Thickness	19 mm
Coating	Melamine coating, resistant to organic solvents, weak acids, gasoline and oil
Colour	light grey RAL 7035
ESD Variant	
Configuration	DIN EN 61340-5-1 Part 5-1 Body volume-conductive
Dimensions	Width
Width	1128 mm, 1428 mm, 1528 mm, 1728 mm, 1928 mm
Depth	375 mm
Height	370 mm + 90 mm one shelf

Ordering no.

Width / for table width	Standard (including system carrier)	ESD (including system carrier) 
1128 mm / 1200 mm	R4-5E	R4-5L
1428 mm / 1500 mm	R4-5D	R4-5K
1528 mm / 1600 mm	R4-5C	R4-5J
1728 mm / 1800 mm	R4-5B	R4-5H
1928 mm / 2000 mm	R4-5A	R4-5G

Suitable system profile (1 pair)

Lenght: 910 mm	R5-1P.0910
----------------	------------

Suitable vertical cable duct

5-fold, Width / Height 30 mm x 30 mm Lenght 910 mm for system profile Lenght 730 mm for table leg	R5-1K.0910
---	------------

primus basic

System-Sliding Doors bench rack



Technical features

- Storage space directly at the workplace
- Suitable for DIN A4 file
- Roller shutter superstructure with lock and foldable key, optionally centrally lockable
- Retrofittable LED lighting
- With central position and height adjustable shelf

Note:

Including system carrier

Orga panel available separately

primus basic

System-Roller-shutter bench rack

Technical data

Body	
Thickness	19 mm
Coating	Melamine coating, resistant to organic solvents, weak acids, gasoline and oil
Colour	light grey RAL 7035
ESD Variant	
Configuration	DIN EN 61340-5-1 Part 5-1 Body volume-conductive
Dimensions	
Width	1128 mm, 1428 mm, 1528 mm, 1728 mm, 1928 mm
Depth	375 mm
Height	370 mm

Ordering no.

Width / for table width	Standard (including system carrier)	ESD (including system carrier) 
1128 mm / 1200 mm	R4-8E	R4-8L
1428 mm / 1500 mm	R4-8D	R4-8K
1528 mm / 1600 mm	R4-8C	R4-8J
1728 mm / 1800 mm	R4-8B	R4-8H
1928 mm / 2000 mm	R4-8A	R4-8G

Suitable system profile (1 pair)

Lenght: 910 mm	R5-1P.0910
----------------	------------

Suitable vertical cable duct

2-fold, Width / Height 30mm x 30 mm Lenght 910 mm for system profile Lenght 730 mm for table leg	R5-1K.0910
--	------------

primus basic

System-Roller-shutter bench rack



Technical features

- Storage space directly at the workplace
- Suitable for DIN A4 file
- Roller shutter superstructure with lock and foldable key, optionally centrally lockable
- Retrofittable LED lighting
- With central position and height adjustable shelf

Note:

Including system carrier

Orga panel available separately

primus basic

System-Roller-shutter bench rack

Technical data

Body	
Thickness	19 mm
Coating	Melamine coating, resistant to organic solvents, weak acids, gasoline and oil
Colour	light grey RAL 7035
Dimensions	
Width	1128 mm, 1428 mm, 1528 mm, 1728 mm, 1928 mm
Depth	375 mm
Height	370 mm

Ordering no.

Width / for table width	Standard (including system carrier)
1128 mm / 1200 mm	R4-6E
1428 mm / 1500 mm	R4-6D
1528 mm / 1600 mm	R4-6C
1728 mm / 1800 mm	R4-6B
1928 mm / 2000 mm	R4-6A

Suitable system profile (1 pair)

Lenght: 910 mm	R5-1P.0910
----------------	------------

Suitable vertical cable duct

2-fold, Width / Height 30 mm x 30 mm Lenght 910 mm for system profile Lenght 730 mm for table leg	R5-1K.0910
---	------------

B primus basic



Accessories primus basic

B5

primus basic

Accessories

Technical data

Description		Order no.
<p>Cover panel D = 75 mm, H = 570 mm</p> <p>made of sheet steel, powder coated Holes 9,5 mm x 9,5 mm Grid 38 mm x 38 mm</p>		<p>For table width 1200 mm R9-4S B1200</p> <p>For table width 1500 mm R9-4S B1500</p> <p>For table width 1600 mm R9-4S B1600</p> <p>For table width 1800 mm R9-4S B1800</p> <p>For table width 2000 mm R9-4S B2000</p>
<p>Interchangeable frame (2 pcs) D = 18 mm, H = 35 mm</p> <p>Interchangeable frame for suspending small parts containers and tool holders as well as training boards of all common teaching systems.</p> <p>Profiles:</p> <ul style="list-style-type: none"> - 2 anodized aluminium profiles, small groove on top and large groove below for simple hooking - lateral fastening strap for infinitely height adjustment - Inside brush strip for noise reduction optionally available 		<p>For table width 1200 mm 76-1C</p> <p>For table width 1500 mm 76-1B</p> <p>For table width 1600 mm 76-1K</p> <p>For table width 1800 mm 76-1A</p> <p>For table width 2000 mm 76-1Y</p>
<p>Primus Basic Endcover for lateral cover of standard cable duct of table.</p> <p>Made of sheet steel, powder coated RAL 7035 light grey including fixing material.</p>		<p>R9-0A</p> 
<p>Primus Basic table height adjuster W = 38 mm, D = 128 mm, H = 720-820 mm 4 adjustable sliding fittings for stepless table foot height adjustment from 720 mm - 820 mm for table height 750 mm - 850 mm. Standard (ESD)</p>		<p>R0-XX Zv1</p> 

primus basic

Accessories

Technical data

Description		Order no.
<p>Hanging profile T = 15 mm, H = 30 mm B=1115; 1415, 1515; 1715, 1915 For hanging material trays</p> <p>Note: Not suitable for TaMas open fronted storage bins C1-6Q/R/S/T</p>		<p>For table width 1200 mm R9-4G.B1200</p> <p>For table width 1500 mm R9-4G.B1500</p> <p>For table width 1600 mm R9-4G.B1600</p> <p>For table width 1800 mm R9-4G.B1800</p> <p>For table width 2000 mm R9-4G.B2000</p>
<p>TFT crossbar W = 1119 mm, 1419 mm, 1519 mm, 1719 mm, 1919 mm D = 91 mm, H = 23 mm</p> <p>For mounting between the rear system profiles, continuously adjustable in height.</p> <p>Profile: -anodized aluminum profile front- and rear- with grooves on the front and rear to accommodate the TFT ball head P3-5L-2 or the support arm support arm P3-5K-2 -on each side with fastening lug, which allows a allows a stepless height adjustment</p> <p>Translated with www.DeepL.com/Translator (free version)</p>		<p>For table width 1200 mm R9-4T.B1200</p> <p>For table width 1500 mm R9-4T.B1500</p> <p>For table width 1600 mm R9-4T.B1600</p> <p>For table width 1800 mm R9-4T.B1800</p> <p>For table width 2000 mm R9-4T.B2000</p>

C Underbench Cabinets



C Underbench cabinets



C1 Underbench cabinets & PC-holder	139
C2 Undertable cabinets Accessories	151

Underbench cabinets & PC-holder

C1

Undertable cabinets



Technical features

- Drawer fronts with and without handles
- All drawers with full pull-out (110%)
- The Handles are chrome matt
- Smooth-running metal drawers with pull-in dampers
- Can optionally be converted to a roller container
- Central lock with folding key, can optionally be incorporated into a locking system
- Tamper-proof locking system, tilt resistance according to DIN 68858
- Wide choice of organizing elements
- ESD [Electrostatic Discharge] variant for EPA [Electrostatic Protective Area] facilities
- Inner width = 327, depth = 490 mm









Undertable cabinets

Technical data

Body	
Thickness	19 mm
Coating	Melamine coating, resistant to organic solvents, weak acids, gasoline and oil
Colour	light grey RAL 7035
Maximum load	
Maximum load-bearing capacity per full pull-out	45 kg
ESD Variant	
Configuration according to	DIN EN 61340-5-1 Part 5-1 Body and drawer volume-conductive
Dimensions	
Width	418 mm
Depth	587 mm
Height	188 / 541 mm
Dimensions (roller container)	
Width	418 mm
Depth	600 mm
Height	631 mm

Undertable cabinets

Technical data

Description		Order-no.
<p>Undertable cabinet</p> <p>H = 200 mm W = 430 mm D = 587 mm</p> <p>Equipment: pull-out shelf 1 drawer 2HU</p> <p>All drawers with full pull-out</p>		<p>U1-1A</p> <p>U1-4A</p> 
<p>Undertable cabinet</p> <p>H = 550 mm W = 430 mm D = 587 mm</p> <p>Equipment: pull-out shelf 1 drawer 3HU 1 drawer 6HU</p> <p>All drawers with full pull-out</p>		<p>U1-1C</p> <p>U1-4C</p> 
<p>Undertable cabinet</p> <p>H = 550 mm W = 430 mm D = 587 mm</p> <p>Equipment: pull-out shelf 1 drawer 2HU 1 drawer 3HU 1 drawer 4HU</p> <p>All drawers with full pull-out</p>		<p>U1-1E</p> <p>U1-4E</p> 
<p>Undertable cabinet</p> <p>H = 550 mm W = 430 mm D = 587 mm</p> <p>Equipment: pull-out shelf 3 drawers 2HU 1 drawer 3HU</p> <p>All drawers with full pull-out</p>		<p>U1-1F</p> <p>U1-4F</p> 

Undertable cabinets



Roller container

Technical data

Description		Order-no.
<p>Roller container</p> <p>Undertable cabinet H = 631 mm W = 424 mm D = 600 mm</p> <p>Equipment: pull-out shelf 1 drawer 3HU 1 drawer 6HU 4 swivel castors Ø 50 mm cover panel 25 mm</p> <p>All drawers with full pull-out</p>		<p>U1-1C.R</p> <p>U1-4C.R</p> 
<p>Roller container</p> <p>H = 631 mm W = 424 mm D = 600 mm</p> <p>Equipment: pull-out shelf 1 drawer 2HE 1 drawer 3HE 1 drawer 4HE 4 swivel castors Ø 50 mm cover panel 25 mm</p> <p>All drawers with full pull-out</p>		<p>U1-1E.R</p> <p>U1-4E.R</p> 
<p>Roller container</p> <p>H = 631 mm W = 424 mm D = 600 mm</p> <p>Equipment: pull-out shelf 3 drawer 2HE 1 drawer 3HE 4 swivel castors Ø 50 mm cover panel 25 mm</p> <p>All drawers with full pull-out</p>		<p>U1-1F.R</p> <p>U1-4F.R</p> 

Undertable cabinets

Technical data

Description		Order-no.
<p>Undertable cabinet</p> <p>H = 188 mm W = 418 mm D = 587 mm</p> <p>Equipment: pull-out shelf 1 drawer 2HE</p> <p>All drawers with full pull-out</p>		<p>U2-1A</p> <p>U2-4A</p> 
<p>Undertable cabinet</p> <p>H = 541 mm W = 418 mm D = 587 mm</p> <p>Equipment: pull-out shelf 1 drawer 3HE 1 drawer 6HE</p> <p>All drawers with full pull-out</p>		<p>U2-1C</p> <p>U2-4C</p> 
<p>Undertable cabinet</p> <p>H = 541 mm W = 418 mm D = 587 mm</p> <p>Equipment: pull-out shelf 1 drawer 2HE 1 drawer 3HE 1 drawer 4HE</p> <p>All drawers with full pull-out</p>		<p>U2-1E</p> <p>U2-4E</p> 
<p>Undertable cabinet</p> <p>H = 541 mm W = 418 mm D = 587 mm</p> <p>Equipment: pull-out shelf 3 drawer 2HE 1 drawer 3HE</p> <p>All drawers with full pull-out</p>		<p>U2-1F</p> <p>U2-4F</p> 

Undertable cabinets

Roll container

Technical data

Description		Order-no.
<p>Roller container</p> <p>H = 631 mm W = 424 mm D = 600 mm</p> <p>Equipment: pull-out shelf 1 drawer 3HE 1 drawer 6HE 4 swivel castors Ø 50 mm cover panel 25 mm</p> <p>All drawers with full pull-out</p>		<p>U2-1C.R</p> <p>U2-4C.R </p>
<p>Roller container</p> <p>H = 631 mm W = 424 mm D = 600 mm</p> <p>Equipment: pull-out shelf 1 drawer 2HE 1 drawer 3HE 1 drawer 4HE 4 swivel castors Ø 50 mm cover panel 25 mm</p> <p>All drawers with full pull-out</p>		<p>U2-1E.R</p> <p>U2-4E.R </p>
<p>Roller container</p> <p>H = 631 mm W = 424 mm D = 600 mm</p> <p>Equipment: pull-out shelf 3 drawer 2HE 1 drawer 3HE 4 swivel castors Ø 50 mm cover panel 25 mm</p> <p>All drawers with full pull-out</p>		<p>U2-1F.R</p> <p>U2-4F.R </p>

Undertable cabinets

PC-undertable cabinet

Technical data

Description		Order-no.
<p>PC-undertable cabinet</p> <p>H = 541 mm W = 297 mm D = 587 mm</p> <p>Equipment: leaf door left, side door right both lockable (single key for all locks) 1 ventilation grille in the rear wall</p>		<p>U1-1S U1-4S</p> 
<p>PC-undertable cabinet</p> <p>H = 541 mm W = 297 mm D = 587 mm</p> <p>Equipment: leaf door right, side door left both lockable (single key for all locks) 1 ventilation grille in the rear wall</p>		<p>U1-1R U1-4R</p> 
<p>Undertable cabinet</p> <p>H = 541 mm W = 418 mm D = 587 mm</p> <p>Equipment: leaf door right, lockable 1 shelf unit, height-adjustable</p>		<p>U1-1J U1-4J</p> 
<p>Undertable cabinet</p> <p>H = 541 mm W = 418 mm D = 587 mm</p> <p>Equipment: leaf door left, lockable 1 shelf unit, height-adjustable</p>		<p>U1-1K U1-4K</p> 

Undertable cabinets







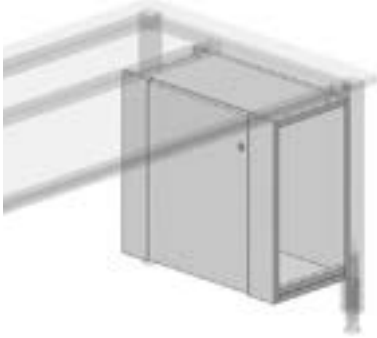

Technical data

Description		Order-no.
<p>Undertable cabinet</p> <p>H = 541 mm W = 418 mm D = 587 mm</p> <p>Equipment 1 hinged door with 90° opening, hinged on the right side 1 shelf adjustable in height in Euro grid 1 lockable safety lock with folding key folding key</p>		<p>U2-1J</p> <p>U2-4J</p> 
<p>Undertable cabinet</p> <p>H = 541 mm W = 418 mm D = 587 mm</p> <p>Equipment 1 hinged door with 90° opening, hinged on the left side 1 shelf adjustable in height in Euro grid 1 lockable safety lock with folding key folding key</p>		<p>U2-1K</p> <p>U2-4K</p> 

PC base cabinets

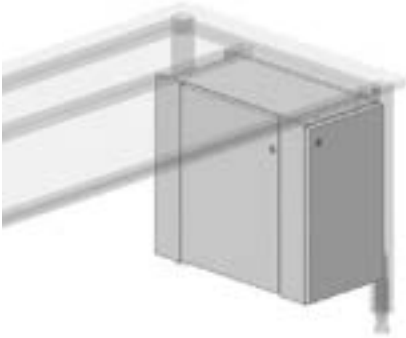
PC base cabinets are available for safe storage of PCs which can also be supplied with lockable front doors. The side door available in the standard series means that PCs always remain accessible for installation.







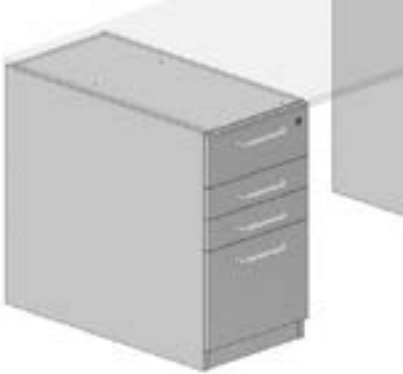

Technical data

Description		Order-no.
<p>PC base cabinet</p> <p>Left side wall with lockable door for access to the PC plug connectors. The rear wall has a ventilation grille. Clearance height inside 500 mm.</p> <p>H = 540 mm W = 300 mm D = 600 mm</p>		<p>E5-1R</p> <p>E5-4R</p> 
<p>PC base cabinet</p> <p>Right side wall with lockable door for access to the PC plug connectors. The rear wall has a ventilation grille. Clearance height inside 500 mm.</p> <p>H = 540 mm W = 300 mm D = 600 mm</p>		<p>E5-1S</p> <p>E5-4S</p> 
<p>PC base cabinet</p> <p>With front door lockable</p> <p>Right-hand front door and left-hand side wall with doors for access to the PC plug connectors. Both doors are lockable. The rear wall has a ventilation grille. Clearance height inside 500 mm.</p> <p>H = 540 mm W = 300 mm D = 600 mm</p>		<p>E5-1R X01</p> <p>E5-4R X01</p> 
<p>PC base cabinet</p> <p>With front door lockable</p> <p>Left-hand front door and right side wall fitted with doors for access to PC plug connectors. Both doors are lockable. The rear wall has a ventilation grille. Clearance height inside 500 mm.</p> <p>H = 540 mm W = 300 mm D = 600 mm</p>		<p>E5-1S X01</p> <p>E5-4S X01</p> 

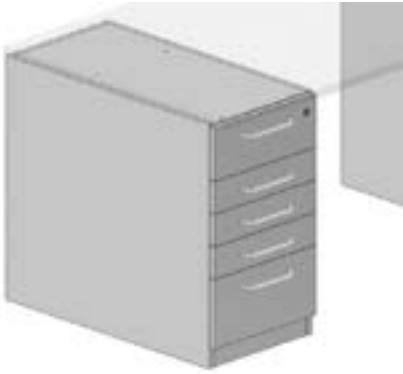
Base cabinets with base

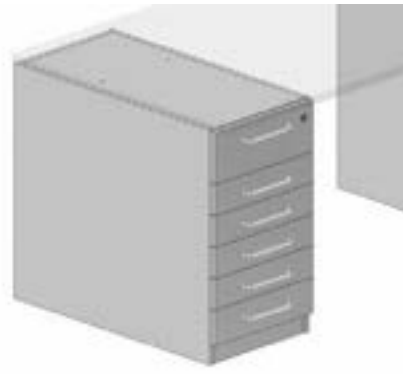
The floor cabinets have a unit depth of 850 mm; the steel plate drawers have an effective depth of 690 mm. They can be used to build compact function units together with individual tabletops from the Primus One and Primus Basic range.

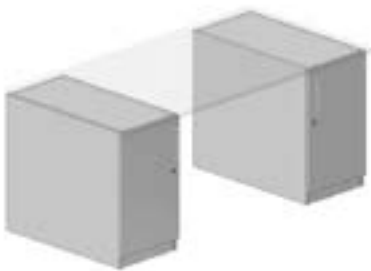
Technical data

Description		Order-no.
<p>Base cabinet with base</p> <p>1 drawer 3 HU 1 drawer 2 HU 1 drawer 2 HU 1 drawer 6 HU 1 formed compartment 1 lock</p> <p>H = 750 mm W = 420 mm D = 850 mm</p>		<p>E5-5F</p> <p>E5-9F</p> 
<p>Base cabinet with base</p> <p>1 drawer 3 HU 1 drawer 2 HU 1 drawer 2 HU 1 drawer 2 HU 1 drawer 4 HU 1 formed compartment 1 lock</p> <p>H = 750 mm W = 420 mm D = 850 mm</p>		<p>E5-5G</p> <p>E5-9G</p> 
<p>Base cabinet with base</p> <p>1 drawer 3 HU 1 drawer 2 HU 1 drawer 2 HU 1 drawer 2 HU 1 drawer 2 HU 1 drawer 2 HU 1 formed compartment 1 lock</p> <p>H = 750 mm W = 420 mm D = 850 mm</p>		<p>E5-5H</p> <p>E5-9H</p> 
<p>Base cabinet with base</p> <p>1 folding door, right 1 adjustable shelf 1 lock</p> <p>1 folding door, left 1 adjustable shelf 1 lock</p> <p>H = 750 mm W = 420 mm D = 850 mm</p>		<p>E5-5J</p> <p>E5-9J</p>  <p>E5-5K</p> <p>E5-9K</p> 

PC-holder

Technical data

Description		Order-no.
<p>PC-holder 3 mm thick sheet steel, for attaching to the table leg, on the left or right inner side.</p> <p>The holder is adjustable from 100 mm to 220 mm to take PCs of different width. Maximum load 25 kg.</p> <p>W = 100...220 mm D = 300 mm H = 220 mm</p>		<p>78-3T</p> 
<p>PC-holder hanging Maximum load 25 kg.</p> <p>W = 70...230 mm H = 310...550 mm</p> <p>Colour black</p>		<p>A9-2B</p>
<p>Assembly brackets for mounting on the outside of table legs</p>		<p>78-3T ZAdapter</p> 
<p>PC-holder for mounting on the rear cross-beam of C-foot system tables, height-adjustable, Series Primus One and Primus Basic. Infinitely adjustable in width.</p> <p>W = 200 mm, D = 600 mm, H = 250 mm.</p> <p>(setting dimensions: W = 190 mm, H = 500, D = 520 mm)</p>		<p>K9-0P.EC</p>

C Undertable cabinets



Undertable cabinets
Accessories

C2

Undertable cabinets

Accessories

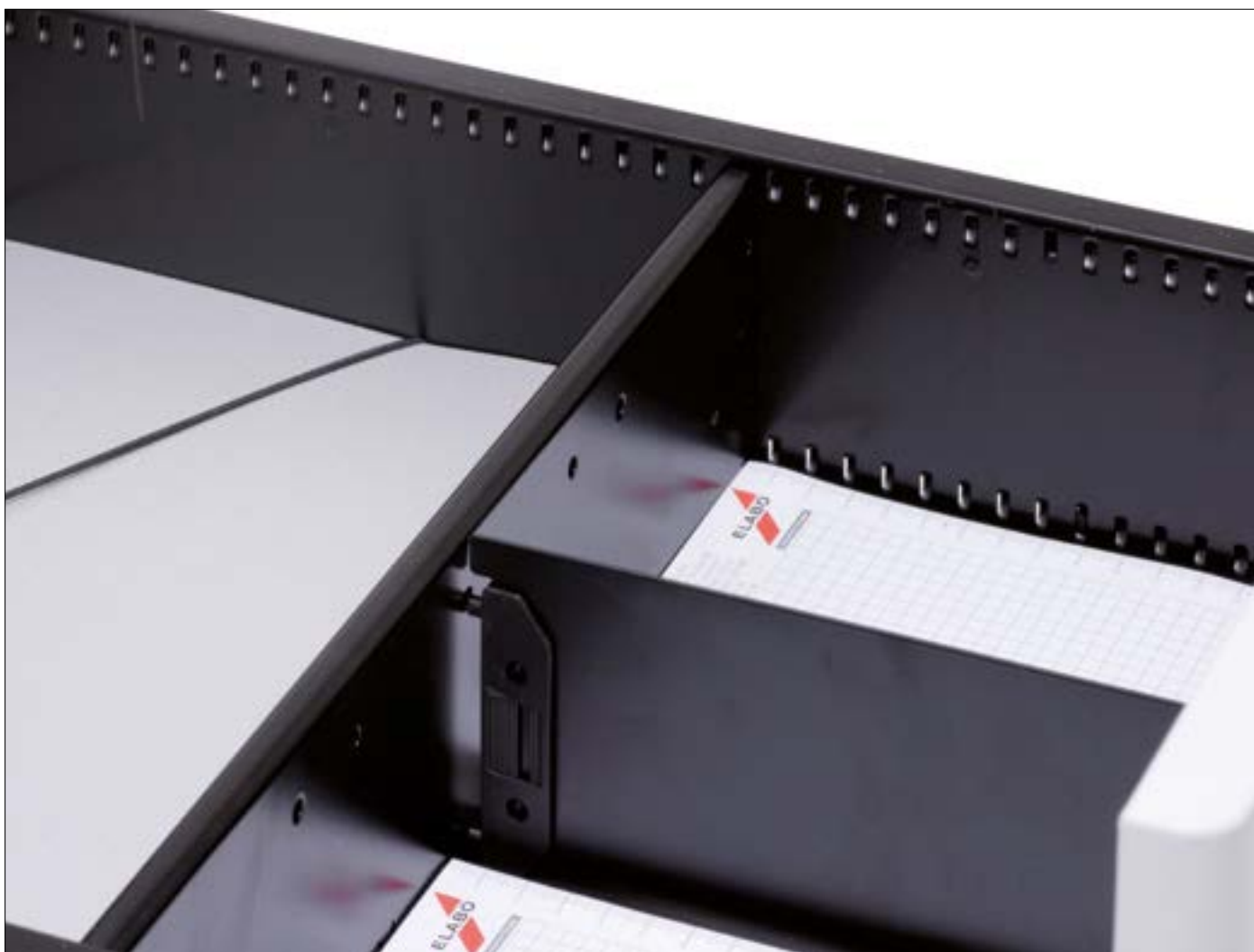



Technical features

- Set of castors for conversion of a suspended container to a roller container
- Dividers for organizing the drawers
- Sets of tools according to purpose
- Insert trays for the storage of small parts

Undertable cabinets

Accessories

Technical data

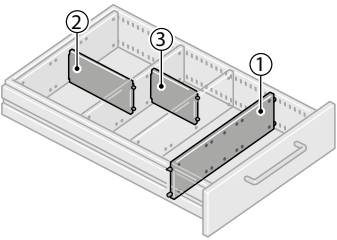
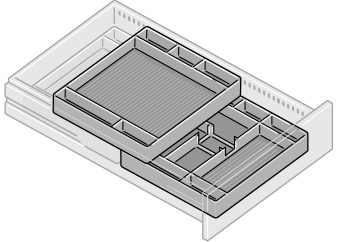
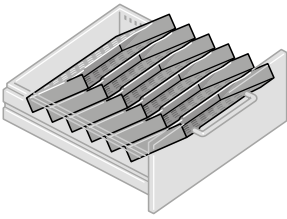
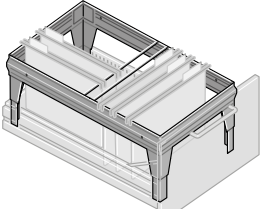
Description			Order-no.
<p>Telescopic guide</p> <p>for all undertable cabinets (see page 143)</p>		<p>Usable depth 490 mm (undertable cabinet 600 mm) 690 mm (undertable cabinet 800 mm)</p>	<p>07-9A 07-9B</p>
<p>Set of castors suitable for Primus One undertable cabinets for subsequent conversion of suspended containers to roller containers</p> <p>Consisting of 4 swivel castors Ø 50 mm Cover panel 25 mm Including assembly material</p>		<p>Standard design</p> <p>ESD design</p>	<p>07-7W 07-7W ESD</p> 
<p>Divider</p> <p>black metal, for sub-dividing drawers</p>		<p>326 mm x 7 mm x 73 mm</p> <p>213 mm x 7 mm x 73 mm</p> <p>153 mm x 7 mm x 73 mm</p>	<p>07-7A 07-7D 07-7E</p>
<p>Insert tray</p> <p>black plastic with four 4-sub divisions 9-sub divisions</p>		<p>325 mm x 325 mm x 40 mm</p> <p>325 mm x 325 mm x 40 mm</p>	<p>07-7M 07-7N</p>
<p>Form-holder system A4,</p> <p>plastic, 6 trays, for useful drawer depth of 490 mm, required drawer height 4HE</p>		<p>326 mm x 450 mm x 212 mm</p>	<p>07-7P</p>
<p>Hanging file system</p> <p>Insertable A4 metal hanging file frame with 1 intermedia- te support, black, for useful drawer depth of 490 mm, required drawer height 6HE</p>		<p>332 mm x 483 mm x 250 mm</p>	<p>07-7S</p>

Undertable cabinets

Accessories

Technical data

Description			Order-no.
Moulded tray Polystyrene with 20 compartments		326 mm x 470 mm x 35 mm	07-8A
Moulded tray Polystyrene with 11 compartments for compo- nents, small parts, etc.		326 mm x 470 mm x 35 mm	07-8B
Moulded tray Polystyrene with 9 compart- ments for storing any combination of tools		326 mm x 470 mm x 35 mm	07-8C
Moulded tray Polystyrene with 8 compartments		326 mm x 470 mm x 35 mm	07-8D
Moulded tray Polystyrene with 5 compartments		326 mm x 470 mm x 35 mm	07-8E

Tool kits



Technical features

- The two-part tool sets "Mechanical" and "Universal" as well as the one-part tool set "Electronic" are optimally stored in two-coloured foam plastic inserts fitted in the 2HU drawers of Elabo's undertable cabinets and roller containers
- The recesses in the black-green insert are matched to the appropriate tools and prevent damage; if needed, to save space, the tool sets can also be stacked one above the other
- Dimensions: Width = 325 mm, Depth = 490 mm, Height = 40 mm
- High quality brand-name tools, with guaranteed ongoing availability
- Neatly arranged and always ready to hand

Tool kits

Technical data

Description		Order-no.
<p>Tool kits Electronic</p> <p>Foam plastic insert with:</p> <ul style="list-style-type: none"> 1 flat round pliers 1 heavy-duty combination pliers 180 mm 1 heavy-duty diagonal cutting pliers 1 wire-stripping pliers 1 screwdriver slotted-head 2,5 mm, 1 screwdriver slotted-head 4,0 mm 1 screwdriver slotted-head 5,5 mm, 1 screwdriver slotted-head 6,5 mm 1 screwdriver Philips head PH 0, 1 screwdriver Philips head PH 1 1 screwdriver Philips head PH 2 1 socket wrench with 3C handle, hexagonal 4,0 mm, 1 socket wrench with 3C handle, hexagonal 5,0 mm 1 socket wrench with 3C handle, hexagonal 5,5 mm, 1 socket wrench with 3C handle, hexagonal 6,0 mm, 1 socket wrench with 3C handle, hexagonal 7,0 mm, 1 socket wrench with 3C handle, hexagonal 8,0 mm 1 set of 6 key files 1 pair of precision tweezers, flat, non-glare, 130 mm long 		81-8R
<p>Tool kits Mechanical</p> <p>Foam plastic insert 1 with:</p> <ul style="list-style-type: none"> 1 hacksaw 1 scribe 250 mm 1 tool kit, set of 6 1 pocket slide calipers 1 nylon hammer 1 engineer's hammer ROTBAND-PLUS 1 wooden folding rule 2 m <p>Foam plastic insert 2 with:</p> <ul style="list-style-type: none"> 1 file brush 1 flat file 8", 200 x 20 mm, cut No. 2 1 triangular file 8", 200 x 14 mm, cut No. 2 1 half-round flat file, 8", 200 x 20 mm, cut No. 2 1 flat scraper 1 triangular hollow-ground scraper 1 set of 6 key files 		81-8S
<p>Tool kits Universal</p> <p>Foam plastic insert 1 with:</p> <ul style="list-style-type: none"> 1 hacksaw 1 universal pliers 10", 15 settings 1 single open-end wrench, adjustable, 10", 1 single open-end wrench, adjustable 6" 1 flat file 8", 200 x 20 mm, cut No. 2 1 triangular file 8", 200 x 14 mm, cut No. 2 1 half-round flat file, 8", 200 x 20 mm, cut No. 2 1 engineer's hammer ROTBAND-PLUS 1 wooden folding rule 2 m <p>Foam plastic insert 2 with:</p> <ul style="list-style-type: none"> 1 screwdriver slotted-head 3,0 mm, 1 screwdriver slotted-head 4,0 mm 1 screwdriver slotted-head 6,5 mm, 1 screwdriver slotted-head 8,0 mm 1 screwdriver, short-form, slotted-head 5,5 mm 1 screwdriver Phillips head PH 1, 1 screwdriver Phillips head PH 2 1 screwdriver Phillips head PH 3 1 screwdriver, short-form, Phillips head PH 2 1 screwdriver 150–250 V, slotted-head 3,0 mm 1 heavy-duty combination pliers 180 mm 1 heavy-duty diagonal cutting pliers 160 mm 1 flat round pliers, 1x flat round pliers 1 Triple pliers 		81-8T

D Illumination



Characteristic value L80/B10

What means the value L80 / B10?

There are various options on the market to indicate the quality and durability of an LED light. The characteristic value L80 / B10 can be used to make statements about the lifetime and luminosity of an LED. The identification specifically indicates the decrease in light output.

What do the values mean and how are they composed?

The characteristic value provides information on how many percent of the original light flux of an LED type is retained over the specified lifetime of the LED. The light flux is measured in the unit lumen and indicates the radiated brightness of a light. This tells you, the buyer, how much luminosity you can rely on during the lifetime of your LED. Or in other words: which LEDs meet a high standard - and which do not!

L80 / B10



Minimum 80% of the light flux is maintained for a defined period of time.

10% of LEDs reach a light flux value that is lower than 80% of the original value in the course of their lifetime



Characteristic value L80/B10

What does this mean for you as a consumer?

In the professional environment, the minimum requirement of L70/B10 should be met for long burning times. This applies, for example, to multi-shift operation in industry. However, a standard of L80/B10 is usually recommended for LEDs. It represents the highest possible level, provides the best reliability and is a sign of high quality. There are also LEDs that do not meet the minimum requirement and lose much more luminosity within their service life.

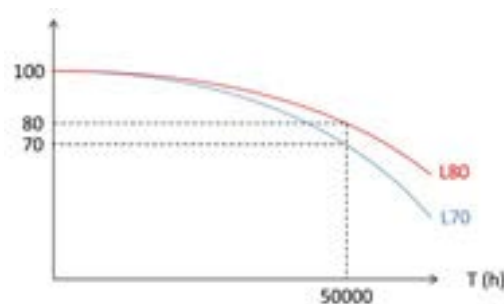

The chart above shows that after 50,000 hours of operation, LEDs are no longer 100% of their initial luminosity. After this lifetime, it is 80% if we follow the red line, 70% if we follow the blue line. Under normal conditions of use, 50,000 hours is equivalent to about 16 years. This is still considerably more than conventional light sources, which lose their luminosity at an early stage. For comparison:

- Fluorescent tubes last about 2 to 6 years,
- Halogen lamps 10 months
- traditional light bulbs only 4 to 8 months.

According to the technical rules for workplaces, illuminance is recommended for the following tables

- office workplace => 500 lx
- electronics workplace => 1.500 lx



Art. No. 75-9F Xxx

ELABO LED-Workstation light

different versions



Microprismen lens



60° LED optic

Technical information

- Perfect illumination with the LED workstation overhead light
- High-quality and robust luminaire body made of eloxated aluminium
- Easy mounting on a cross-beam
- Service life L80 / B10 at 50,000 h
- Standard with GST18 connection
- Various versions
 - microprism lens
 - 60 ° LED-optic

Variant information

- microprism lens

The microprism lens ensures homogeneous illumination, more visual comfort and less strain during general assembly and inspection work. And this especially with reflective surfaces. For general inspection work in accordance with workplace regulations.
- 60 ° LED-Optics

The high-quality 60° LED optic ensures uniform illumination with low system power as well as optimal glare control. This innovative LED optic reduces light diffusion and therefore achieves better illumination with less power.

Technical data

General data	
Colour temperature (CCT)	5000 K
Lifetime	L80 / B10 at 50.000 h
Protection class	IP40
Value	< 22
Mounting	Cross beam
Colour reproduction	Ra>80

Ordering no.

Light width	Light direction system	Version	Connection	Order number
900 mm	Microprism lens (28,9 Watt / 2867 lm)	ON / OFF	Schuko	75-9F X20
			hard wired	75-9F X20-V
		dimmable	Schuko	75-9F X20-D
			hard wired	75-9F X20-VD
	60° LED-optic (16,7 Watt / 2427 lm)	ON / OFF	Schuko	75-9F X21
			hard wired	75-9F X21-V
		dimmable	Schuko	75-9F X21-D
			hard wired	75-9F X21-VD
1200 mm	Microprism lens (37,8 Watt / 3822 lm)	ON / OFF	Schuko	75-9F X30
			hard wired	75-9F X30-V
		dimmable	Schuko	75-9F X30-D
			hard wired	75-9F X30-VD
	60° LED-Optic (21,6 Watt / 3239 lm)	ON / OFF	Schuko	75-9F X31
			hard wired	75-9F X31-V
		dimmable	Schuko	75-9F X31-D
			hard wired	75-9F X31-VD

LED Orga light with Orga-panel and touch unit



Technical features

- LED Orga light is operated via touch unit in closing cap
- The light color is steplessly adjustable from „warm white“(3000K) to „cold white“ (5000K) via touch unit
- Continuously dimmable 0-100%
- The number of light segments is determined by the width of the panel
- Lighting can be individually adjusted to the working area
- Optional LAN interface for remote control of lighting via tablet available
- Optional touch control unit for additional operation of the LED light on the available
- Lockable drawer, optionally centrally lockable
- Small parts container optionally available
- Optimal cable routing using cable guides

Fits the following product ranges:

- K4-2... / R4-2...
- K4-4... / R4-4...
- K4-5... / R4-5...
- K4-6... / R4-6...
- K4-7... / R4-7...
- K4-8... / R4-8...

LED Orga light with Orga-panel and touch unit

Technical data

Colour temperature	
LED-lighting	2700-5000 K (warm white)
Maximum load	
Weight loading Orga panel	10 kg surface load capacity
Dimensions	
Width	1200 mm, 1500 mm, 1600 mm, 1800 mm, 2000 mm
Depth	164 mm
Height	90 mm

Ordering no. control unit left

Width	Number of light segments	For shelf element	For superstructure
1200 mm	2	K4-1E.A5-LI	K4-1E.T5-LI
1500 mm	3	K4-1D.A5-LI	K4-1D.T5-LI
1600 mm	3	K4-1C.A5-LI	K4-1C.T5-LI
1800 mm	4	K4-1B.A5-LI	K4-1B.T5-LI
2000 mm	4	K4-1A.A5-LI	K4-1A.T5-LI

Ordering no. control unit left and right

Width	Number of light segments	For shelf element	For superstructure
1200 mm	2	K4-1E.A5-LI+RE	K4-1E.T5-LI+RE
1500 mm	3	K4-1D.A5-LI+RE	K4-1D.T5-LI+RE
1600 mm	3	K4-1C.A5-LI+RE	K4-1C.T5-LI+RE
1800 mm	4	K4-1B.A5-LI+RE	K4-1B.T5-LI+RE
2000 mm	4	K4-1A.A5-LI+RE	K4-1A.T5-LI+RE

Suitable Options

Touch unit for right side	K4-1X
LAN interface	K4-1Y

Suitable Accessories

<p>Accessories boxes (set) consisting of: 2 x W = 52 mm, D = 52 mm, H = 35 mm 2 x W = 52 mm, D = 78 mm, H = 35 mm 2 x W = 52 mm, D = 104 mm, H = 35 mm</p>		<p>K9-4B</p> 
---	---	--

LED Orga light with Orga-panel



Technical features

- Optimal wide-area workplace lighting using LED technology
- Choice between light colours "warm white" and "cold white"
- Optimal cable routing using cable guides
- Lighting can be individually adjusted to the working area
- Lockable drawer, optionally centrally lockable
- Small parts container optionally available

Fits the following product ranges:

- K4-2... / R0-2...
- K4-4... / R0-4...
- K4-5... / R0-5...
- K4-6... / R0-6...
- K4-7... / R0-7...
- K4-8... / R0-8...

LED Orga light with Orga-panel



Technical data

Colour temperature	
LED-lighting	4000 K (warm white) or 6000 K (cold white)
Maximum load	
Weight loading Orga panel	10 kg surface load capacity
Dimensions	
Width	1200 mm, 1500 mm, 1600 mm, 1800 mm, 2000 mm
Depth	164 mm
Height	90 mm

Ordering no.

Width	For shelf element 4000 K	For shelf element 6000 K	For superstructure 4000 K	For superstructure 6000 K
1200 mm	K4-1E.A2	K4-1E.A3	K4-1E.T2	K4-1E.T3
1500 mm	K4-1D.A2	K4-1D.A3	K4-1D.T2	K4-1D.T3
1600 mm	K4-1C.A2	K4-1C.A3	K4-1C.T2	K4-1C.T3
1800 mm	K4-1B.A2	K4-1B.A3	K4-1B.T2	K4-1B.T3
2000 mm	K4-1A.A2	K4-1A.A3	K4-1A.T2	K4-1A.T3

Suitable Accessories

	<p>Accessories boxes (set) consisting of: 2 x W = 52 mm, D = 52 mm, H = 35 mm 2 x W = 52 mm, D = 78 mm, H = 35 mm 2 x W = 52 mm, D = 104 mm, H = 35 mm</p>	<p>K9-4B </p>
---	---	---

LED-lighting

Light for assembly underneath function shelf



Technical features

- Slim LED-cabinet luminaire
- CRI of 83,1 (X01) / 94,7 (X11) guarantees accurate color rendering
- Low power consumption by latest LED-technology
- Expandable modularly
- Sensor-controlled dimmer module
- Swiveling and without glare due to special lens shape

LED-lighting

Light for assembly underneath function shelf

Technical data

Specifications	X01 (X02)	X11 (X12)
Width	1000 mm	1000 mm
LED-lighting	4000 K	4000 K
LED Spacing	5 mm	0,5 mm
Radiation angle	ca. 90°	ca. 90°
Power assumption	11 W(3 W)	24,6 W
Light flux	650 lm (190 lm)	2000 lm (600 lm)
CRI (4000K)	83,1	94,7
Operating voltage	24 V	24 V
Features		
Sensor-controlled dimmer module	Yes	Yes
Mains power supply	Yes	Yes
Continuous line of light (Prism structure)	No	Yes
Colour accuracy for quality control	No	Yes
Expandable	Yes	Yes

Basic module



Scope of delivery:

1x Luminaire 1000 mm
1x Mains power supply
1x Power supply 36 W
1x Dimmer module (Touch)
2x Mounting clip
1x Set of fixing material

Ordering no.
75-9D X01

75-9D X11

Extension module



Scope of delivery:

1x Luminaire 300 mm
1x Connecting piece
2x Mounting clip
1x Set of fixing material

Ordering no.
75-9D X02

75-9D X12

Workplace lighting



Technical features

- Additional lamp for crossbeam, consisting of self-supporting aluminum profile, anodized
- Power supply via WIELAND-plug-in system GST 18/3 (1 x IN, 3 x OUT)
- With 2 x T5 fluorescent lamp 39W/840, neutral-white
- High luminous efficiency by shiny-anodized reflector
- Electronical ballast (EVG) for flicker free high frequency operation at about 40 kHz, flicker free instant start and prevention of stroboscopic effects.
- Including On-/ Off-switch (dimmer function optionally available on request)

Workplace lighting

Technical data

Specifications	
Width (luminaire)	899 mm
LED-lighting	Neutral white 4000 K
Power rating	82 W
Light flux	6200 lm
Socket	2x T5 HO 39/840
Operating voltage	230 V
Service life (lamps)	24.000 h

Scope of delivery:

- 1x Workplace lighting including electrical ballast (EVG)
- 1x Fixing device (adjustable in inclination)

Ordering no.
75-9F X01

Technical data (LED-version)

Specifications	
Width (luminaire)	870 mm
LED-lighting	Neutral white 4000 K
Power rating	30 W
Operating voltage	230 V
Service life (lamps)	50.000 h

Scope of delivery:

- 1x Workplace lighting including electrical ballast (EVG)
- 1x Fixing device (adjustable in inclination)

Ordering no.
75-9F X02

LED-lighting

Magnifying light

Technical data

Description		Order no.
<p>LED-magnifying lamp Including mains power supply</p> <p>1 x LED module 4W, neutral white, dimmable</p> <p>The ring-shaped LED magnifier lamp permits an object to be enlarged and illuminated with targeted accuracy. The item being examined is enlarged with a magnification of 2.3 by means of a distortion-free Eschenbach plastic lens having a diameter of 70 mm and a power of 5.3 diopters.</p> <p>Note: Suitable rotary adapter P3-5N-3</p>		85-1E
<p>LED-magnifying lamp, dimmable for ESD-areas</p> <p>Consisting of luminaire head, stand pipe with joint. Operating by sensor switch. Dimmer function by pushing button for longer.</p> <p>Including plastic foot for screw connection to work surface. Clamping foot optionally available.</p> <p>Technical data: Mains power: 100 - 240 V 50/60 Hz Protection class: IP20 LED-module: 14 Watt, neutral white 48 premium SMD-LEDs</p> <p>Magnifier strenght: 3,5 diopter Magnifier: diameter 160 mm Material: Aluminum, plastic Joint arm: 500/484 mm</p> <p>Plug-in transformer Clamp adapter for magnifying luminaire ESD-version</p>		<p>85-1EZESD</p> <p>85-1F ZESD</p> 
<p>Rotation adapter to mount on system profile for LED desk light</p> <p>cone diameter 13 mm or 16 mm</p>		K9-4D

E Mobiles



Table of contents

E1 Carrier Cart	173
E2 Power Cart	181
E3 Laboratory Cart Tool Trolley	189
E4 System-Laboratory Cart	193

Carrier Cart

primus one



Carrier Cart



E1

primus one

Carrier Cart Back



Technical features

- Height profiles mounted offset to the rear
- Can be individually fitted with transverse elements
- Robust base plate
- 4 large double swivel castors 125 mm diameter, 2 of them lockable

Technical data

Dimensions	
Width	823 mm
Depth	685 mm
Height	1187 mm, 1667 mm, 1907 mm
Equippable height for transverse elements	980 mm, 1459 mm, 1700 mm
Castors	
Number	4
Diameter	125 mm
Lockable	2
Base plate	
Thickness	19 mm
Coating	Melamine coating, resistant to organic solvents, weak acids, gasoline and oil
ESD variant	
Castors	ESD Configuration
Configuration	DIN EN 61340-5-1 Part 5-1

Ordering no.

Height	Width	Depth	Ordering no.	Ordering no. for ESD 
1187 mm	823 mm	685 mm	K7-1E	K7-1E.ESD
1667 mm	823 mm	685 mm	K7-1C	K7-1C.ESD
1907 mm	823 mm	685 mm	K7-1A	K7-1A.ESD

primus one

Carrier Cart Center



Technical features

- Height profiles mounted in the centre
- Can be individually fitted with transverse elements
- Robust base plate
- 4 large double swivel castors 125 mm diameter, 2 of them lockable

Technical data

Dimensions	
Width	823 mm
Depth	685 mm
Height	1187 mm, 1667 mm, 1907 mm
Equippable height for transverse elements	980 mm, 1459 mm, 1700 mm
Castors	
Number	4
Diameter	125 mm
Lockable	2
Base plate	
Thickness	19 mm
Coating	Melamine coating, resistant to organic solvents, weak acids, gasoline and oil
ESD variant	
Castors	ESD Configuration
Configuration	DIN EN 61340-5-1 Part 5-1

Ordering no.

Height	Width	Depth	Ordering no.	Ordering no. for ESD 
1187 mm	823 mm	685 mm	K7-1L	K7-1L.ESD
1667 mm	823 mm	685 mm	K7-1J	K7-1J.ESD
1907 mm	823 mm	685 mm	K7-1G	K7-1G.ESD

primus one

Accessories Carrier Cart

Technical data

Description		Order-no.
<p>Function shelf for Carrier Cart back Infinitely tiltable to 30° Anti-slip edge at front and back side Heavy load slot at top and bottom</p> <p>W = 704 mm, D =400 mm</p>		<p>K7-3C K7-3C.ESD </p>
<p>Function shelf for Carrier Cart center</p> <p>not tiltable</p> <p>Anti-slip edge at front and back side Heavy load slot at top and bottom</p> <p>W = 704 mm, D =500 mm</p>		<p>K7-3D K7-3D.ESD </p>
<p>Edging strip for function shelf</p> <p>W = 694 mm, H = 50 mm</p>		<p>K7-5C </p>
<p>Shelf element for Carrier Cart back</p> <p>W =776 mm, D =400 mm, H = 90 mm</p> <p>Note: Orga panel available separately Including system carrier</p>		<p>K7-3A.S K7-3A.S_ESD </p>
<p>Interchangeable frame profile made of anodized aluminum</p> <p>W =704 mm, D =18 mm, H = 35 mm</p> <p>Note: 1 Set = 2 pieces</p>		<p>K7-4H</p>

primus one

Accessories Carrier Cart

Technical data

Description		Order-no.
<p>Perforated plate with Euro-standard holes</p> <p>9,2 mm x 9,2 mm</p> <p>made of sheet steel, conductive powder coating</p> <p>W = 704 mm, D = 24 mm, H = 341 mm</p>		<p>K7-4M</p> 
<p>Conductive powder coating suitable for all types of carts</p> <p>W = 704 mm, D = 400 mm, H = 150 mm</p> <p>Load-bearing capacity 30 kg</p> <p>Drawer with locking handle and partial extension</p>		<p>K7-4L</p> 
<p>Universal carrier rail</p> <p>W = 703 mm, D = 25 mm, H = 100 mm</p> <p>Note: For attaching open-front storage containers manufactured by Bosch, Kappes, Schäfer and Treston, cable reels, etc. Stepless height adjustment</p>		<p>K7-2U</p>
<p>PC-holder made of sheet steel, conductive powder coating</p> <p>suitable for all types of carts</p> <p>W = 190 mm, D = 450 mm, H = 200 mm</p> <p>Height-adjustable on the system profile</p>		<p>K7-5A</p> 
<p>TFT traverse made of anodized aluminum profile</p> <p>W = 704 mm, D = 23 mm, H = 92 mm</p> <p>For mounting between the system profiles, stepless height adjustment For accepting accessories, such as TFT brackets</p>		<p>K7-5B</p>

primus one

Accessories Carrier Cart

Technical data

Description		Order-no.
<p>System 60 carrier rail</p> <p>System 60 metal carrier rail for holding sockets and data bars as well as compresSet air supplies. Height-adjustable, made of powder-coated sheet steel.</p> <p>W = 704 mm, D = 74 mm, H = 62 mm</p>		<p>K7-3H</p> 
<p>Storage tray</p> <p>made of powder-coated sheet steel height-adjustable</p> <p>W = 704 mm, D = 200 mm, H = 30 mm</p>		<p>K7-3G</p> 
<p>Socket strips System 60</p> <p>Plastic strip with mains input plug and directly bridged mains output socket System GST-18, sockets rotated 45° for angled plugs Colour: black 3 shock-free sockets 5 shock-free sockets On/Off switch, 3 shock-free sockets On/Off switch, 5 shock-free sockets</p>		<p>C1-8A C1-8B C1-8C C1-8D</p>
<p>Mains connecting cable for socket strips system 60</p> <p>3-pole cable. 1.5 mm² cross section for mains connection and for connecting the system 60 socket strips and the 1 HE.</p> <p>Safety plug – GST-18 socket L = 200 cm Safety plug – GST-18 socket L = 300 cm Safety plug – GST-18 socket L = 400 cm</p> <p>GST-18 plug – GST-18 socket L = 50 cm GST-18 plug – GST-18 socket L = 100 cm GST-18 plug – GST-18 socket L = 250 cm</p>		<p>C1-8V ZL200 C1-8V ZL300 C1-8V ZL400</p> <p>C1-8W ZL50 C1-8W ZL100 C1-8W ZL250</p>
<p>Keyboard tray with lateral ball-bearing guides, extensible up to 230 mm. Lockable in end positions.</p> <p>Height-adjustable in 11 mm grid Clearance dimensions of the tray: W = 600 mm, D = 267 mm</p> <p>W = 680 mm, D = 300 mm, H = 85-110 mm</p>		<p>85-4F-2</p>

E Mobile



Power Cart

primus one



Power Cart



E2

primus one

Power Cart back



(Equipment not contained in package)

Technical features

- Electrical wiring can be provided in the profile
- Lockable access to bottom assembly
- 4 large double swivel castors Ø 125 mm, 2 of them lockable

Note:

Electrical lead (see chapter accessories) and fuse protection (see chapter Primus One panels) have to be ordered additionally.

Technical data

Dimensions	
Width	975 mm
Depth	685 mm
Height (mounting height)	1187 / (960) mm, 1667 / (1440) mm, 1907 / (1680) mm
Castors	
Number	4
Diameter	125 mm
Lockable	2
Bottom assembly	
Storage volume	Width = 840 mm, Depth = 280 mm, Height = 85 mm
Theft protection	Lockable flap
ESD variant	
Castors	ESD Configuration
Configuration	DIN EN 61340-5-1 Part 5-1

Ordering no.

Height	Width	Depth	Ordering no.	Ordering no. for ESD 
1187 mm	975 mm	685 mm	K7-2E	K7-2E.ESD
1667 mm	975 mm	685 mm	K7-2C	K7-2C.ESD
1907 mm	975 mm	685 mm	K7-2A	K7-2A.ESD

primus one

Power Cart 3HU



(Equipment not contained in package)

Technical features

- With 3HU electrical bench-rack
- Can be fitted with Elabo devices or third-party devices
- Electrical wiring can be provided in the profile
- Lockable access to bottom assembly
- 4 large double swivel castors Ø 125 mm, 2 of them lockable

Note:

Electrical lead (see chapter accessories) and fuse protection (see chapter Primus One panels) have to be ordered additionally.



Technical data

Dimensions	
Width	975 mm
Depth	685 mm
Height (mounting height)	1689 / (1260) mm
Mounting width bench rack	162HP
Mounting option	480 / 480 / 300 mm
Castors	
Number	4
Diameter	125 mm
Lockable	2
Bottom assembly	
Storage volume	Width = 840 mm, Depth = 280 mm, Height = 85 mm
Theft protection	Lockable flap
ESD variant	
Castors	ESD Configuration
Configuration	DIN EN 61340-5-1 Part 5-1

Ordering no.

Height	Width	Depth	Ordering no.	Ordering no. for ESD 
1689 mm	975 mm	685 mm	K7-2N	K7-2N.ESD

primus one

Power Cart 6HU



Technical features

- With 6HU electrical bench rack
- Can be fitted with Elabo devices or third-party devices
- Electrical wiring can be provided in the profile
- Lockable access to bottom assembly
- 4 large double swivel castors Ø 125 mm, 2 of them lockable

Note:

Electrical lead (see chapter accessories) and fuse protection (see chapter Primus One panels) have to be ordered additionally.



(Equipment not contained in package)

Technical data

Dimensions	
Width	975 mm
Depth	685 mm
Height (mounting height)	1844 / (1260) mm
Mounting width bench rack	162HP
Mounting option	480 / 480 / 300 mm
Castors	
Number	4
Diameter	125 mm
Lockable	2
Bottom assembly	
Storage volume	Width = 840 mm, Depth = 280 mm, Height = 85 mm
Theft protection	Lockable flap
ESD variant	
Castors	ESD Configuration
Configuration	DIN EN 61340-5-1 Part 5-1

Ordering no.

Height	Width	Depth	Ordering no.	Ordering no. for ESD 
1844 mm	975 mm	685 mm	K7-2Q	K7-2Q.ESD

primus one

Power Cart accessories

Technical data

Description		Order-no.
<p>Function shelf for Power Cart</p> <p>Infinitely tiltable to 30° Anti-slip edge at front and back side Heavy load slot at top and bottom</p> <p>W = 704 mm, D = 400 mm</p>		<p>K7-4C K7-4C.ESD </p>
<p>Edging strip for function tray</p> <p>W = 694 mm, H = 50 mm</p>		<p>K7-5C </p>
<p>Shelf element for Power Cart</p> <p>W = 928 mm, D = 400 mm, H = 90 mm</p> <p>Note: Orga panel available separately Including system carrier</p>		<p>K7-4.S K7-4A.S_ESD </p>
<p>Orga-panel for assembly under a superstructure or shelf element</p> <p>W = 880 mm, D = 164 mm, H = 90 mm</p> <p>Pull-out drawer with cable routing Integrated LED lighting Light colour 6000K</p>		<p>K7-4P</p>
<p>Drawer block made of steel sheet suitable for all types of carts</p> <p>conductive, powder-coated</p> <p>W = 704 mm, D = 400 mm, H = 150 mm Load-bearing capacity 30 kg</p> <p>Drawer with locking handle and partial extension</p>		<p>K7-4L </p>
<p>Storage tray made of powder-coated sheet steel height-adjustable</p> <p>W = 704 mm, D = 200 mm, H = 30 mm</p>		<p>K7-3G </p>

primus one

Power Cart accessories

Technical data

Description		Order-no.
<p>Power Cart Add-on table</p> <p>with fold-away cable flap and cable duct</p> <p>W = 928 mm, D = 650 mm, H = 180 mm</p> <p>For note: Add-on table for mounting between the system profiles, stepless height adjustment.</p>		<p>K7-4T</p> <p>K7-4T.ESD</p> 
<p>Perforated plate</p> <p>with Euro-standard holes 9,2 mm x 9,2 mm made of sheet steel, conductive powder coating</p> <p>W = 704 mm, D = 24 mm, H = 341 mm</p>		<p>K7-4M</p> 
<p>Interchangeable frame profile made of anodized aluminum</p> <p>W = 704 mm, D = 18 mm, H = 35 mm</p> <p>Note: 1 Set = 2 pieces</p>		<p>K7-4H</p>
<p>PC-holder suitable for all types of carts</p> <p>made of sheet steel, conductive powder coating</p> <p>W = 190 mm, D = 450 mm, H = 200 mm</p> <p>Height-adjustable on the system profile</p>		<p>K7-5A</p> 
<p>TFT traverse made of anodized aluminum profile</p> <p>W = 704 mm, D = 23 mm, H = 92 mm</p> <p>For mounting between the system profiles, stepless height adjustment For accepting accessories, such as TFT brackets</p>		<p>K7-5B</p>

primus one

Power Cart accessories

Technical data

Description		Ordering no.
<p>Universal carrier rail</p> <p>W = 703 mm, D = 25 mm, H = 100 mm</p> <p>Note: For attaching open-front storage containers manufactured by Bosch, Kappes, Schäfer and Treston, cable reels, etc. Stepless height adjustment</p>		<p>K7-2U</p> 
<p>Keyboard tray with lateral ball-bearing guides, extensible up to 230 mm. Lockable in end positions.</p> <p>Height-adjustable in 11 mm grid Clearance dimensions of the tray: W = 600 mm, D = 267 mm</p> <p>W = 680 mm, D = 300 mm, H = 85-110 mm</p>		<p>85-4F-2</p>
<p>Connecting lead 5 m TKW-Purflex</p> <p>VDE 5G2,5 mm² yellow Page 1: CEE-Plug-C516 IP44 - 5-pole 16 A Page 2: stripped 12 cm with cable end sleeves</p> <p>VDE 3G1,5 mm² yellow Page 1: Schuko plug 3-pole 16 A Page 2: stripped 12 cm with cable end sleeves</p> <p>Print: ELABO GmbH 07951/307-0 www.elabo.de</p>		<p>7406CEE16A 5X2,5-5PF</p> <p>7406SCH 3X1,5-5PF</p>
<p>Warning lamp LED red to indicate that the mains voltage has been released Red Red / Green Red / Yellow / Green</p> <p>mounted on Primus One® system profile. Mounting either left or right, Primus Basic profile and table structure wood</p>		<p>red 01-94.L101 red / green 01-94.L201 red / green / yellow 01-94.L301</p>
<p>Warning lamp mounting kit for mounting of Warning lamp LED 01-94.Lx</p>		<p>Primus One® right 01-94.HP01</p> <p>Primus One® left 01-94.HP02</p> <p>Primus Basic 01-94.HB01</p> <p>wooden structure 01-94.HA01</p>

E Mobile



Laboratory Cart Tool Trolley

E3

Laboratory cart

Tool trolley



Technical features

- Two 3 HU Orga-steel sheet drawers
- Two swing doors with lock
- Seven integrated pull-outs for Clip-O-Flex® profile rails
- Storage compartment at right side for containers W = 160 mm
- Four Clip-O-Flex® profile rails over the whole width, fixed on the rear side
- ESD [Electrostatic Discharge] variant for EPA [Electrostatic Protective Area] facilities
- Shelf with rim and rubber mat at the top

Laboratory cart

Tool trolley

Technical data

Table top	
Thickness	30 mm
Frontedge	Edge strip 3 mm thick
Coating	HPL laminate 0.8 mm, non-glare, abrasion-resistant in accordance with EN 438, heat-resistant for short periods
Colour	Light grey RAL 7035
Castors	
Diameter	75 mm
Configuration	4 double swivel castors, 2 of them lockable, with polyurethane tyres
Maximum load	
Maximum weight	180 kg
ESD variant	
Table top	Same properties as standard model but volume-conductive
Configuration	DIN EN 61340-5-1 Part 5-1
Double swivel castors	Electrically conductive
Dimensions	
Width	937 mm
Depth	685 mm
Height	1600 mm

Ordering no.

Standard	ESD 
K7-4W	K7-4W.ESD

Suitable accessories

Standard	Description	Dimension
K7-4W.Tablar	Tablar	W = 520 mm, D = 345 mm

E Mobiles



System-Laboratory Cart

E4

System-Laboratory Cart



Edge strip



F-edging

Technical features



- System function shelf with transverse profile, height adjustable
- 4 double swivel casters (low wear) with precision ball wearing for easy handling, 2 of them lockable
- Highly durable table top with exchangeable front edge
- ESD [Electrostatic Discharge] variant for EPA [Electrostatic Protective Area] facilities
- Width 510 mm (suitable for holding undertable cabinets)

System-Laboratory Cart

Technical data

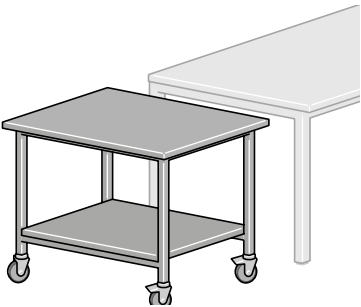

Table top	
Thickness	30 mm
Frontedge	Edge strip 3 mm thick or Flexi-Line edging, exchangeable (F-edging)
Coating	HPL laminate 0.8 mm, non-glare, abrasion-resistant in accordance with EN 438, heat-resistant for short periods
Colour	light grey RAL 7035
Castors	
Diameter	75 mm
Configuration	4 double swivel castors, 2 of them lockable, with polyurethane tyres
Maximum load	
Maximum weight	180 kg
ESD variant	
Table top	Same properties as standard model but volume-conductive
Configuration	DIN EN 61340-5-1 Part 5-1
Double swivel castors	Electrically conductive
Dimensions	
Width	510 mm
Depth	800 mm / 900 mm / 1000 mm
Height	750 mm

Ordering no.

Depth	Width	F- Edging	Edge stripe	F-edging ESD 	Edge stripe ESD 
800 mm	510 mm	K7-7A	K7-7A.S	K7-7D	K7-7D.S
900 mm	510 mm	K7-7B	K7-7B.S	K7-7E	K7-7E.S
1000 mm	510 mm	K7-7C	K7-7C.S	K7-7F	K7-7F.S

System-Laboratory Cart

Technical data

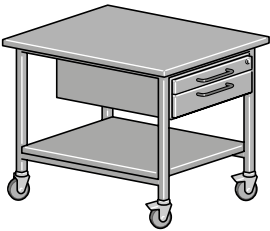
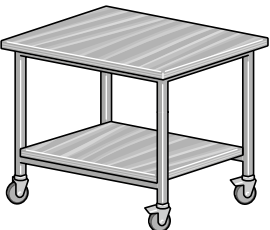
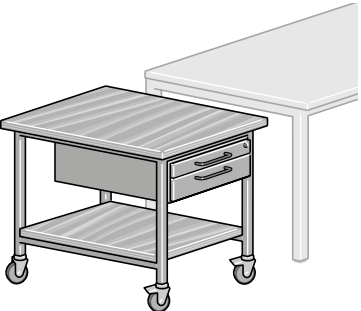
Description		Order-no.
<p>Laboratory Cart</p> <p>Tabletop and storage shelf 30 mm thick, covered with laminate, edges with impact-resistant edge strips</p> <p>W = 600 mm, D = 900 mm, H = 780 mm</p> <p>W = 600 mm, D = 1000 mm, H = 780 mm</p>		<p>01-6A</p> <p>01-5U</p>  <p>01-6U</p> <p>01-5V</p> 
<p>Laboratory Cart with drawer</p> <p>With single drawer Type 71-1A, tabletop and storage shelf 30 mm thick, covered with laminate, edges with impact-resistant edge strips</p> <p>W = 600 mm, D = 900 mm, H = 780 mm</p> <p>W = 600 mm, D = 1000 mm, H = 780 mm</p>		<p>01-6S</p> <p>01-6V</p>
<p>Laboratory Cart multiplex plate</p> <p>Multiplex tabletop and storage shelf made of 14 glued plywood layers, 30 mm thick</p> <p>W = 600 mm, D = 900 mm, H = 780 mm</p>		<p>01-6C</p>
<p>Laboratory Cart Multiplex panel with drawer</p> <p>Laboratory trolley with single drawer, Multiplex tabletop and storage shelf made of 14 glued plywood layers, 30 mm thick</p> <p>W = 600 mm, D = 900 mm, H = 780 mm</p>		<p>01-6T</p>

F General accessories



F

Interchangeable frame technology



Technical features

The interchangeable frame technology makes it possible to have individualized adjustment and allocation for alternating work processes. The suspension elements can be adjusted easily and accessibly, depending on the task at hand. The interchangeable frame rails made of extruded aluminium profile are mounted between the vertical profiles. The suspension elements can be simply inserted into the grooves of the aluminium H profiles and slide without difficulty laterally along the entire width of the table or also be replaced with one another.

The support rails can be attached within the vertical profiles at any required position. DIN A4 experiment boards from all common teaching systems can also be attached.

Interchangeable frame technology

Technical data

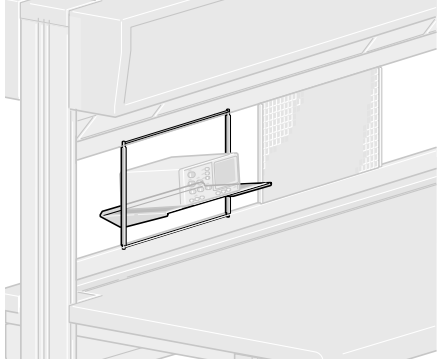
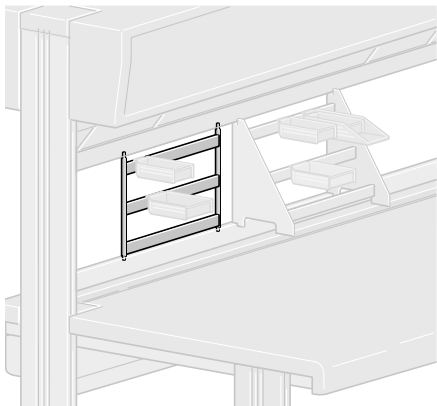
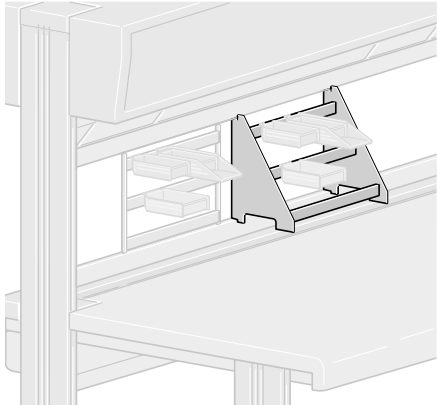
Description		Order-no.
<p>Measuring device platform</p> <p>A stable frame with pivotable storage surface and anti-slip mat, suitable for setting up measuring devices, soldering stations, etc.</p> <p>W = 378 mm, D = 290 mm, H = 297 mm</p>	 A 3D perspective rendering of a measuring device platform. It consists of a rectangular metal frame with a flat top surface. The platform is mounted on a workbench, and a small electronic device is placed on top of it. The workbench has a vertical support post and a horizontal shelf above the platform.	76-1D
<p>Grab container rack</p> <p>for mounting in the interchangeable frame</p> <p>W = 378 mm, D = 20 mm, H = 297 mm</p>	 A 3D perspective rendering of a grab container rack. It is a rectangular metal frame with three horizontal bars. The rack is mounted on a workbench, and three small rectangular containers are placed on the bars. The workbench has a vertical support post and a horizontal shelf above the rack.	76-1E
<p>Grab container</p> <p>holder for mounting in the interchangeable frame or for placing on the table or on a pivot arm. For 3 rows of grab containers.</p> <p>W = 378 mm, D = 250 mm, H = 297 mm</p>	 A 3D perspective rendering of a grab container holder. It is a rectangular metal frame with three horizontal bars. The holder is mounted on a workbench, and three small rectangular containers are placed on the bars. The workbench has a vertical support post and a horizontal shelf above the holder.	76-1F

Interchangeable frame technology

Technical data

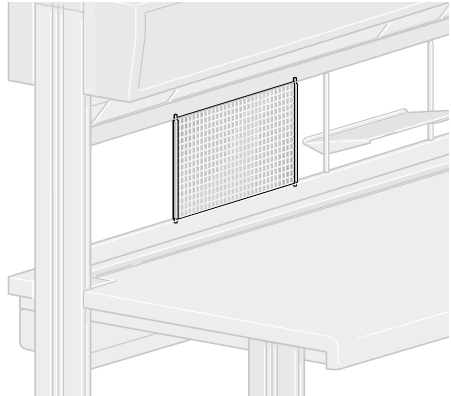
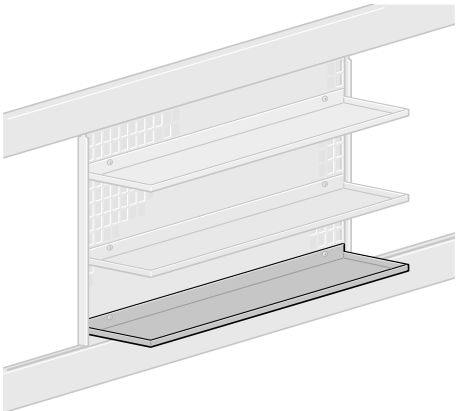
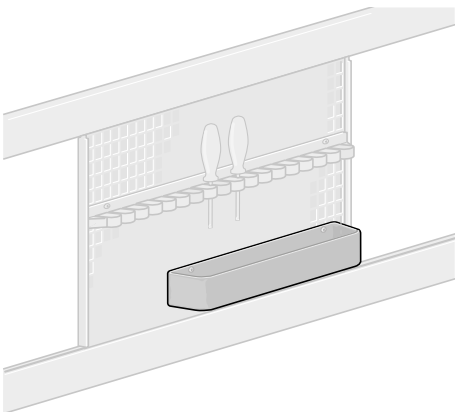
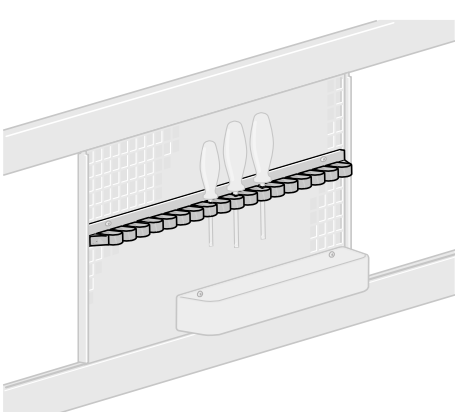
Description		Order-no.
<p>Perforated grid</p> <p>suitable for the mounting of storage boards, storage trays, tool holders and other assembly aids.</p> <p>Perforation 5 mm x 10 mm</p> <p>with 3 mm bridge</p>		76-1G
<p>Patchboard</p> <p>suitable for mounting shelf boards, storage trays, tool holders and other assembly aids</p> <p>W = 448 mm, D = 115 mm, H = 10 mm</p>		76-1H
<p>Storage tray</p> <p>made of polystyrene for mounting on the function shelf or on the perforated panel</p> <p>W = 390 mm, D = 80 mm, H = 45 mm</p>		83-6L
<p>Tool holder</p> <p>for rapid storage of various tools within easy Reach . To save space, the individual clips can be removed. For mounting on the perforated panel or on the function shelf.</p> <p>with 6 Clips, W = 150 mm, D = 40 mm, H = 30 mm</p> <p>with 20 Clips, W = 440 mm, D = 40 mm, H = 30 mm</p>		81-8Q 81-8P

Interchangeable frame technology



Technical features

Grab containers provide small parts close hand in the assembly area or the equipment work station. Our grab tray range (1) is available in 2 widths, and grab trays, grab containers and grab tongues of the same width can be combined according to your purposes.

The grab containers (2) can be used with the aid of three different elements:

1. Hanger profile
2. Grab container shelf for hanging in the InForm variable frame
3. Grab container tray for hanging in the variable frame as well as for placing on the worktable or on a swivel arm.

Grab containers allow you to keep parts close at hand at your work station. They are inserted into the grab tongue. The grab tongue facilitates quick and secure part removal due to its separating area. You can also remove parts directly from the grab container.

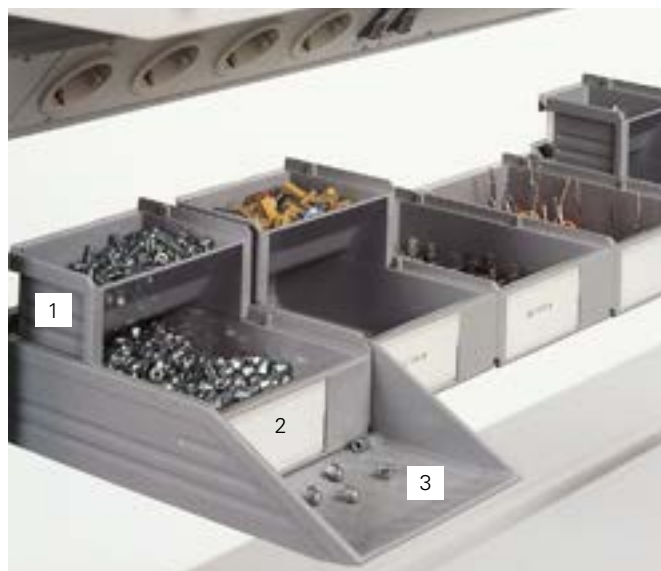

The integrated lip allows quick and safe removal of parts.







Grab tongues (3) consist of two functional parts: The grab container with the equipment components is placed in the rear compartment. The front part corresponds with ergonomic requirements for quick and safe removal of parts. A small number of parts are scooped onto the removing area. These pre-sorted parts can be easily recognised and removed quickly and safely.

Advantages:

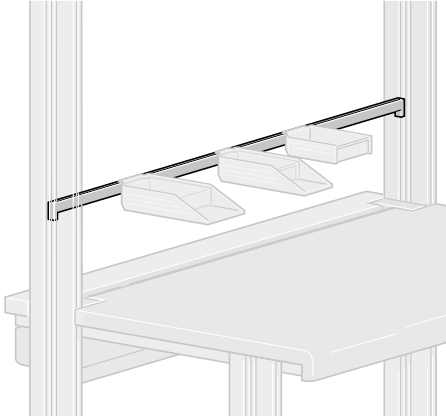
- Optimum provision of parts kept within reach
- Ergonomic grab tongue for picking up parts quickly and safely
- System elements can be combined in a multitude of ways
- Clear marking of parts

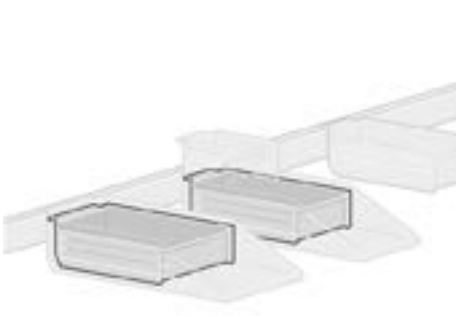

Grab container

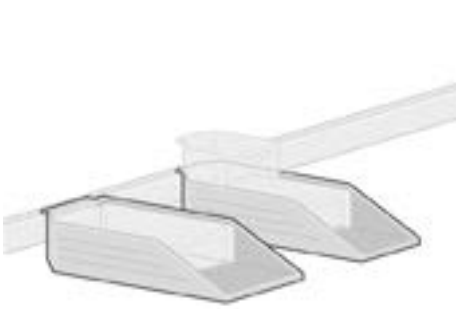
Technical data

Description		Order-no.
<p>Hanger profile (Primus Basic) For quick attachment and removal of grab containers</p> <p>For table width 2000 mm : W = 1928mm x D = 15 mm, H = 30 mm For table width 1800 mm : W = 1728mm x D = 15 mm x H = 30 mm For table width 1600 mm : W = 1528mm x D = 15 mm x H = 30 mm For table width 1500 mm : W = 1428mm x D = 15 mm x H = 30 mm For table width 1200 mm : W = 1128mm x D = 15 mm x H = 30 mm</p> <p>Also available in ESD design </p>		<p>R9-4G.B1200 R9-4G.B1500 R9-4G.B1600 R9-4G.B1800 R9-4G.B2000</p>
<p>Grab container Standard</p> <p>W = 82 mm x D = 86 mm x H = 50 mm W = 123 mm x D = 86 mm x H = 50 mm</p> <p>W = 82 mm x D = 86 mm x H = 50 mm W = 123 mm x D = 86 mm x H = 50 mm</p> <p>Also available in ESD design </p>		<p>76-2E 76-2F</p> <p>76-2G 76-2H</p>
<p>Grab container Standard</p> <p>W = 82 mm x D = 173 mm x H = 50 mm W = 123 mm x D = 173 mm x H = 50 mm</p> <p>W = 82 mm x D = 173 mm x H = 50 mm W = 123 mm x D = 173 mm x H = 50 mm</p> <p>Also available in ESD design </p>		<p>76-2J 76-2K</p> <p>76-2L 76-2M</p>
<p>Grab tongue Standard</p> <p>W = 90 mm x D = 277 mm x H = 54 mm W = 131 mm x D = 277 mm x H = 54 mm</p> <p>W = 90 mm x D = 277 mm x H = 54 mm W = 131 mm x D = 277 mm x H = 54 mm</p> <p>Also available in ESD design </p>		<p>76-2N 76-2P</p> <p>76-2Q 76-2R</p>





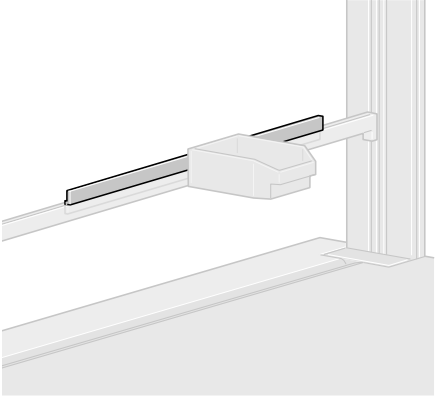

Grab container

Technical data

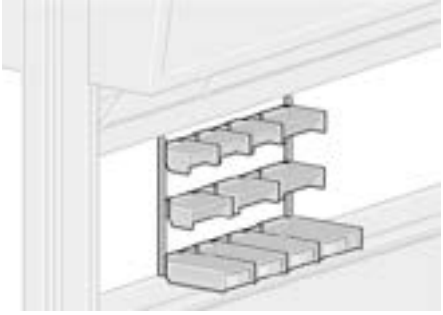
Description		Order-no.
<p>Labelling clip</p> <p>With the labelling clip, the material can be marked easily and securely; the labelling clip fits all grab containers</p> <p>Set of 10 pieces</p>		76-2S
<p>Adaptor rail</p> <p>made of PVC, for insertion on the hanger profiles The adaptor rail allows storage containers of various brands to be hung up on the hanger profile</p> <p>W = 500 mm x D = 6 mm x H = 24 mm</p> <p>Also available in ESD design </p>		76-2D

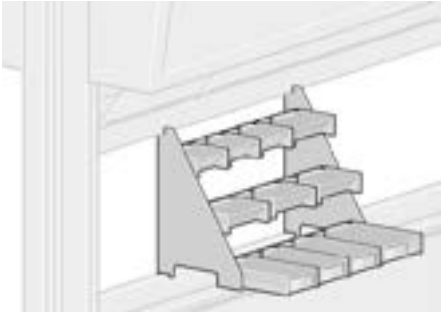
Grab container

Technical data

Description		Order-no.
<p>Grab container- set</p> <p>incl. hanger profile rail 76-1E</p> <p>Set consists of:</p> <p>3 x Grab trays 76-2E, W = 82 mm x 86 mm x 50 mm</p> <p>4 x Grab trays 76-2F, W = 123 mm x 86 mm x 50 mm</p> <p>3 x Grab containers 76-2J, W = 82 mm x 86 mm x 50 mm</p> <p>1 x Grab container 76-2K, W = 123 mm x 86 mm x 50 mm</p> <p>1 x Labelling clip 76-2S</p> <p>Also available in ESD design</p>		<p>76-2W</p> <p>76-2W ZESD</p> 
<p>Grab container- set</p> <p>incl. hanger profile rail 76-1F</p> <p>Set consists of:</p> <p>9 x Grab containers 76-2J, W = 82 mm x 173 mm x 50 mm</p> <p>3 x Grab containers 76-2K, W = 123 mm x 173 mm x 50 mm</p> <p>1 x Labelling clip 76-2S</p> <p>Also available in ESD design</p>		<p>76-2X</p> <p>76-2X ZESD</p> 
<p>Accessory box (Set)</p> <p>Set consists of:</p> <p>2 pieces accessory box black W = 52 mm, D = 52 mm, H = 35 mm</p> <p>2 Pieces accessory box black W = 52 mm, D = 78 mm, H = 35 mm</p> <p>2 Pieces accessory box black W = 52 mm, D = 104 mm, H = 35 mm</p> <p>Material: Conductive Polypropylen</p>		<p>K9-4B</p> 



Accessories

Technical data

Description		Order-no.
<p>Adapter for mounting accessories at the front side of Primus One functional shelf.</p> <p>For screws of 5 mm diameter.</p> <p>Made of sheet steel powder coated. Colour black grey RAL 7021.</p>		K9-9F
<p>Spring nuts for mounting accessories</p> <p>for M5</p> <p>for M6</p> <p>for M8</p> <p>Set consists of 4 nuts with accessories</p>		<p>78-2HZM5</p> <p>78-2H</p> <p>78-2J</p>
<p>TFT-holder</p> <p>for mounting on the TFT traverse</p> <p>For VESA mounting 75 / 100 mm including Quick release, load-bearing capacity 8 kg, Reach 125 mm</p>		P3-5L-2
<p>TFT- swivel arm</p> <p>for mounting on the TFT traverse</p> <p>For VESA mounting 75 / 100 mm including Quick release, load-bearing capacity 8 kg, Reach 275 mm</p>		P3-5K-2



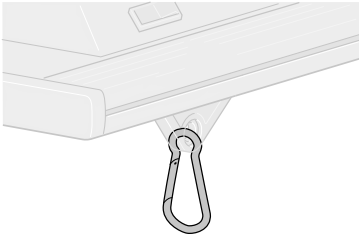

Accessories

Technical data

Description		Order-no.
<p>Pivot arm for balancer with inserted slide.</p> <p>Mounted on the height profile at the front or at the side.</p> <p>W = 630 mm, D = 18 mm, H = 35 mm</p>		78-4S
<p>Balancer</p> <p>Steel housing with a load-bearing capacity of 1 ... 2 kg</p> <p>Spring force adjustment by means of adjusting wheel.</p> <p>Maximum cable extension 1.5 m, including 1 snap hook</p> <p>W = 106 mm, D = 43 mm, H = 180 mm</p>		78-4Q
<p>Balancer for compressed air tools</p> <p>Spring mechanism with hose system and rapid-action valve coupling.</p> <p>W = 145 mm, D = 80 mm, H = 230 mm</p> <p>Hose extension 800 mm. Load capacity adjustable 0.4 ... 0.8 kg</p>		78-4R
<p>Snap hook made of steel, for hanging the balancer in the balancer slide</p>		78-4P

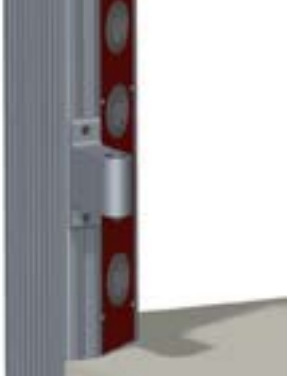
Accessories

Technical data

Description		Order-no.
<p>TFT pivot arm rotation adapter</p> <p>for mounting series P3-5M</p> <p>monitor support arms as well as magnifier lamp</p>		<p>P3-5N-3 for Ø 16 mm</p>
<p>Rotating sleeve</p> <p>for 16 mm insertion pin for mounting on the front profile of a function shelf</p>		<p>K9-4C.D16</p> 
<p>TFT pivot arm rotation adapter</p> <p>Rotation adapter for mounting on Primus One system profile</p>		<p>P3-5N-5</p>
<p>Monitor support arm (aluminium)</p> <p>Height and Reach infinitely adjustable. Gas pressure technology to facilitate height adjustment. Monitor connection by quick release. Reach 365 mm VESA-standard 75/100 Load-bearing capacity 7-15 kg</p>		<p>P3-5M-1</p>

Accessories

Technical data

Description		Order-no.
<p>Monitor support arm (aluminium)</p> <p>Height and reach infinitely adjustable. Gas pressure technology for facilitate height adjustment. Monitor connection by quick release. Reach 515 mm VESA-standard 75/100 Load-bearing capacity 7-15 kg</p>		P3-5M-2
<p>Monitor support arm (aluminium)</p> <p>Height and reach infinitely adjustable. Gas pressure technology to facilitate height adjustment. Monitor connection by quick release. Reach 515 mm VESA-standard 75/100 Load-bearing capacity 7-15 kg</p>		P3-5M-3
<p>Monitor support arm (aluminium)</p> <p>Continuously height-adjustable 2-part articulated arm with articulated arm with VESA standard monitor attachment and pivot function via universal joint. Compensation mechanism at the front part for optimal positioning of the monitor.</p> <p>Reach 415 mm VESA-standard 75/100 Load-bearing capacity 6 kg</p>		P3-5K-10
<p>Tablet holder</p> <p>Tablet holder for easy inserting and removing of various tablets. Holder for tablets of size 7 bis 10 inches. (clamping length 160-300 mm) Tablets of size 10 inches can be optionally fixed vertically or horizontally. Tablet connection by quick release.</p> <p>Suitable for all VESA-standard connections 75/100.</p>		P3-5K-10





Accessories

Technical data

Description		Order-no.
<p>TFT-swivel arm</p> <p>for height-adjustable installation on the narrow or broad sides of the profile, for monitors up to 15 kg</p> <p>D = 455 mm, H = 200 mm</p> <p>Consisting of: 1 VESA adapter 75/100 for mounting monitor 2 horizontal pivoting joints 1 ball couplin</p>		P3-5K
<p>TFT bracket</p> <p>for height-adjustable mounting on the front side of profile, for monitors up to 15 kg</p> <p>D = 125 mm, H = 115 mm</p> <p>Consisting of: 1 VESA adapter 75/100 for mounting monitor 1 horizontal pivoting joint 1 ball couplin</p>		P3-5L
<p>Keyboard tray</p> <p>with lateral ball-bearing guides, extensible up to 230 mm. Lockable in end positions</p> <p>Height-adjustable in 11 mm grid</p> <p>Clearance dimensions of the tray: W= 600 mm, D = 267 mm W= 680 mm, D = 300 mm, H = 85...110 mm</p>		85-4F-1
<p>Keyboard tray</p> <p>with lateral ball-bearing guides, extensible up to 230 mm. Lockable in end positions.</p> <p>Height-adjustable in 11 mm grid</p> <p>Clearance dimensions of the tray: W = 600 mm, D = 267 mm W = 680 mm, D = 300 mm, H = 85-110 mm</p>		85-4F-2
<p>Swivel Storage Arm</p> <p>Suitable for measuring instruments, tools, bins shelf, tablets, etc.</p> <p>Platform made from sheet aluminium with non-slip finish.</p> <p>Platform: W = 390 mm, H = 300 mm load-bearing capacity 7 kg 25° tiltable</p>		78-3M.K

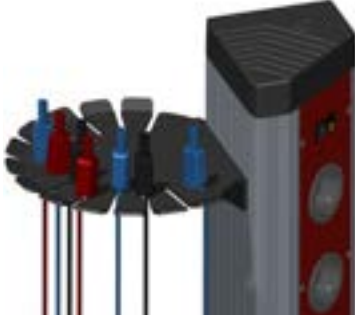

Accessories

Technical data

Description		Order-no.
<p>Cable suspension device 2 fold</p> <p>W = 220 mm, D = 61 mm, H = 120 mm</p> <p>Plastic half-shells, white Suitable for storing cables and measuring cables at the Primus One system profile. Including mounting material</p>		K9-9K.Z01
<p>Holder for measuring cables 13 fold</p> <p>W = 380 mm, D = 200 mm, H = 25 mm</p> <p>Consisting of a semicircular measuring cable holder made from aluminium sheet metal, coated with synthetic resin.</p> <p>With 13 slots for hanging up laboratory-type and connecting cables of various diameters, including mounting</p>		K9-9N 
<p>Cable reel holder made of powder-coated sheet metal suitable for universal carrier rail</p> <p>W = 137 mm, D = 220 mm, H = 95 mm</p> <p>For accepting cable reels with a maximum diameter of 200 mm, a width of 105 mm and an internal diameter of 18 mm or 16 mm</p>		T3-7A
<p>Cable reel holder made of powder-coated sheet metal suitable for universal carrier rail</p> <p>W = 105 mm, D = 220 mm, H = 95 mm</p> <p>For accepting cable reels with a maximum diameter of 200 mm, a width of 80 mm and an internal diameter of 18 mm or 16 mm</p>		T3-7B

Accessories

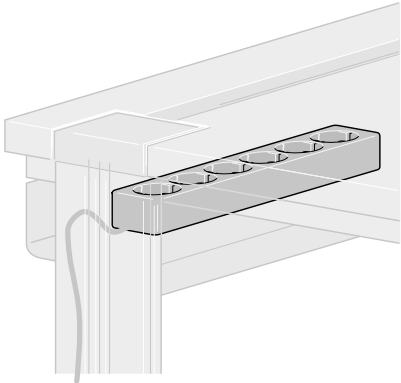
Technical data

Description		Order-no.
<p>5-fold table socket</p> <p>with switch and 1.5 m connection line, colour white. Fits in the table channel or for installation on the profile.</p> <p>1 set of mounting plates</p> <p>W = 290 mm, T = 50 mm, H = 40 mm</p>		<p>81-2C Z01</p> <p>81-2E</p>
<p>6-fold table socket</p> <p>with 1.5 m connection line, colour white. Fits in the table channel or for installation on the profile.</p> <p>W = 330 mm, D = 50 mm, H = 40 mm</p>		<p>81-2D Z01</p>
<p>Socket Strip „Turn3“</p> <p>for assembly in table-tops</p> <p>W = 270 mm, D = 109 mm, H = 92 mm</p>		<p>81-2D ZTURN</p>
<p>Socket Strip Axial</p> <p>for assembly in table-tops</p> <p>Lid opens and closes automatically by pressure</p> <p>W = 305 mm, D = 162,5 mm, H = 71 mm</p>		<p>81-2D ZAXIAL</p>

Accessories

Technical data

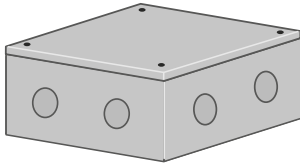
Description		Best-Nr.
<p>Mains connection</p> <p>2.5 m 3 x 1.5 mm² with shockproof plug</p>		83-2A
<p>Mains cable</p> <p>2.5 m 5 x 2.5 mm² with 5-pin Cekon plug 400 V 16 A</p>		83-2C
<p>Cable outlet</p> <p>2-part cable admission box, D = 80 mm, installation on the left, centre or right.</p> <p>Z=Please indicate mounting</p>		81-2K Z
<p>Connection housing</p> <p>connection housing for the mains connection in the cable tray. Sturdy plastic housing with fixed integrated 8-pole series terminal strip.</p> <p>W = 95 mm, D = 95 mm, H = 55 mm</p>		78-4V
<p>EMERGENCY-OFF switch</p> <p>mounted in the plastic housing, incl. fastening angle for installation on the vertical profile.</p> <p>Connection cable preassembled with ferrules.</p> <p>W = 68 mm, D = 68 mm, H = 50 mm</p>		78-4W

G Electronics



Table of contents

G1 Software and networking technology	215
G2 System 3HU	228
G3 System 6HU	309
G4 System 3HU Training	382

G Electronics



Software and networking technology

G1

ELABO elution suite

elution



Highlights

Elabo Elution® Device simplifies the testing of electrical and electronic components used in research and development, production and quality assurance, as well as for service and repair. In addition to measuring electrical parameters, the software can also process digital and analog signals.

General data

- Scope of delivery: 1 DVD box including Elution® Device, SQL Server Express, operating instructions and online help
- License: single workstation
- Languages: German and English, other languages available on request
- Login: password-protected or as Windows user
- Operation: mouse, touch, with Windows look & feel; multiple monitoring possible
- SQL platform; local database or server solution
- Data export in csv-, xls files for further processing



ELABO elution suite

elution



For research and development

- Elabo Elution® Device can reproduce values for you at any time
- The recording function gives you continuous logging of all measured values, without any gaps
- With Elution® Device you can carry out long-term test runs fully automatically
- The measured values are stored in an SQL database, which means that you can transfer all data at any time to other platforms
- Long-term tests and stress tests
- Clock generator
- Setpoint/actual value comparison in graphs and tables

For automatic end of line test and quality assurance

- With Elabo Elution® you can define a test sequence with chronological processing of test steps that subsequently runs in semi-automatic or fully automatic mode
- As required, you can integrate test instructions, digital images or wait steps into the test sequence
- You can work with product identifiers such as bar codes, etc. and, as a result, you can track the values of a device throughout its entire lifetime

We also offer the Elution® System software package as part of the Elution® Suite for use in production and quality assurance. Please contact us, if necessary, to determine which program is better suited for your needs.

For service and repair

- Elabo Elution® can reproduce values for you at any time
- The recording function gives you continuous logging of all measured values, without any gaps
- With Elution® Device you can carry out long-term test runs fully automatically
- The measured values are stored in an SQL database, which means that you can transfer all data at any time to other platforms
- You can work with product identifiers such as bar codes, etc. and, as a result, you can track the values of a device throughout its entire lifetime
- Troubleshooting is simplified by means of predefined test sequences
- Setpoint lists can be programmed for calibration purposes

Requirements

Operating systems supported: Windows

Additional requirements: Devices with Ethernet interfaces, additional equipment licenses, .NET framework must be installed on the computer(s)

ELABO elution suite

elution device

Module: System

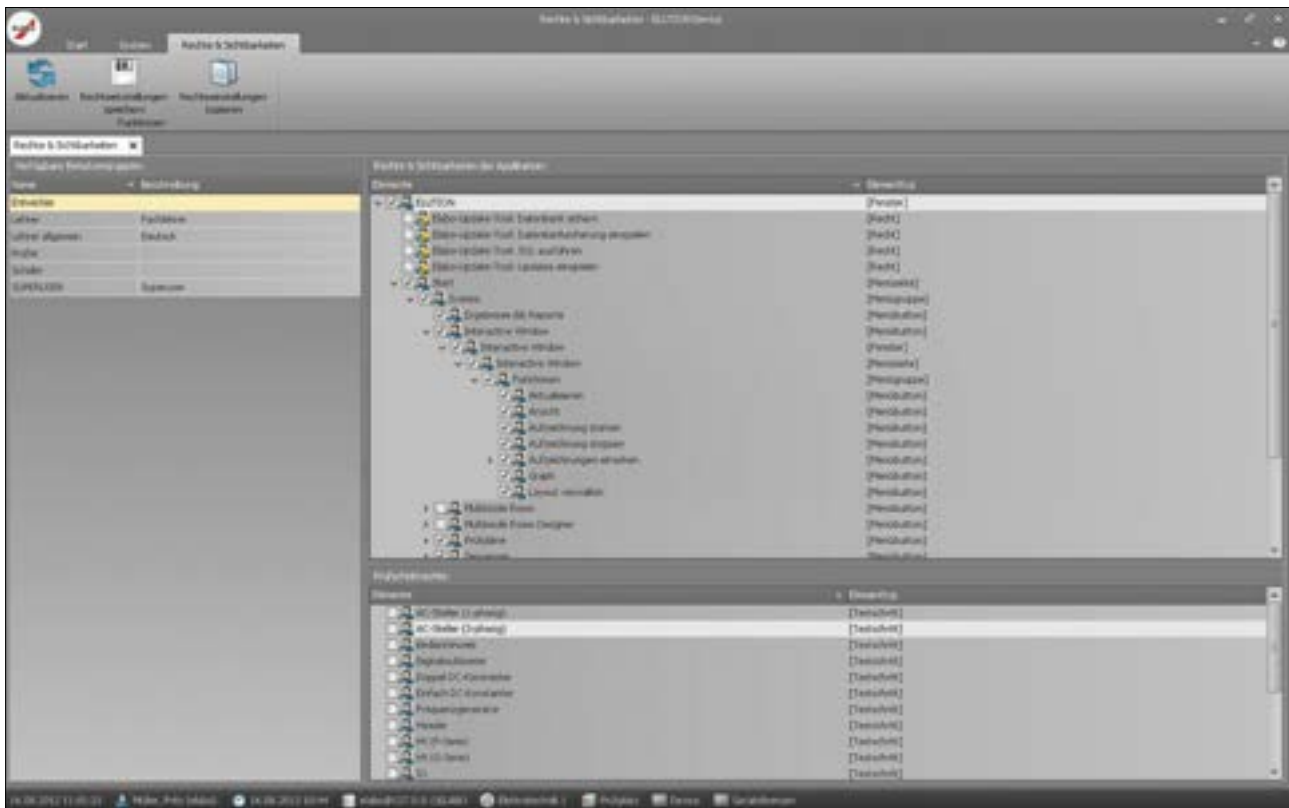

- System administration
- User administration
- Group administration
- Update

Features

1. Fine-tuned granting of user rights
2. User-dependent menu structures
3. Central configuration of all equipment and systems

Functions

- Assignment of names for devices and equipment
- Administration of product types, number ranges
- Administration of licenses
- Determination of network configuration
- Selection of language
- Create users and assign rights to them
- Create user groups, allocate users and assign rights to them

ELABO elution suite

elution device

Module: Interactive Window



- Direct operation of devices
- Graphic display
- Logging
- Export function

Features

1. Graph scaling freely adjustable
2. Each individual decimal point can be selected and modified
3. All devices viewable at a glance

Functions

- All active devices displayed
- All measured values displayed in one or more graphs
- Measuring of Delta X and Delta Y values in the graphic display with possibility of directly comparing the time curves
- Data logging function with adjustable measurement rate
- Storage of measured values in an SQL database (manually, automatically)
- On-top function for using individual devices in other applications

ELABO elution suite

elution device

Module: Sequencer

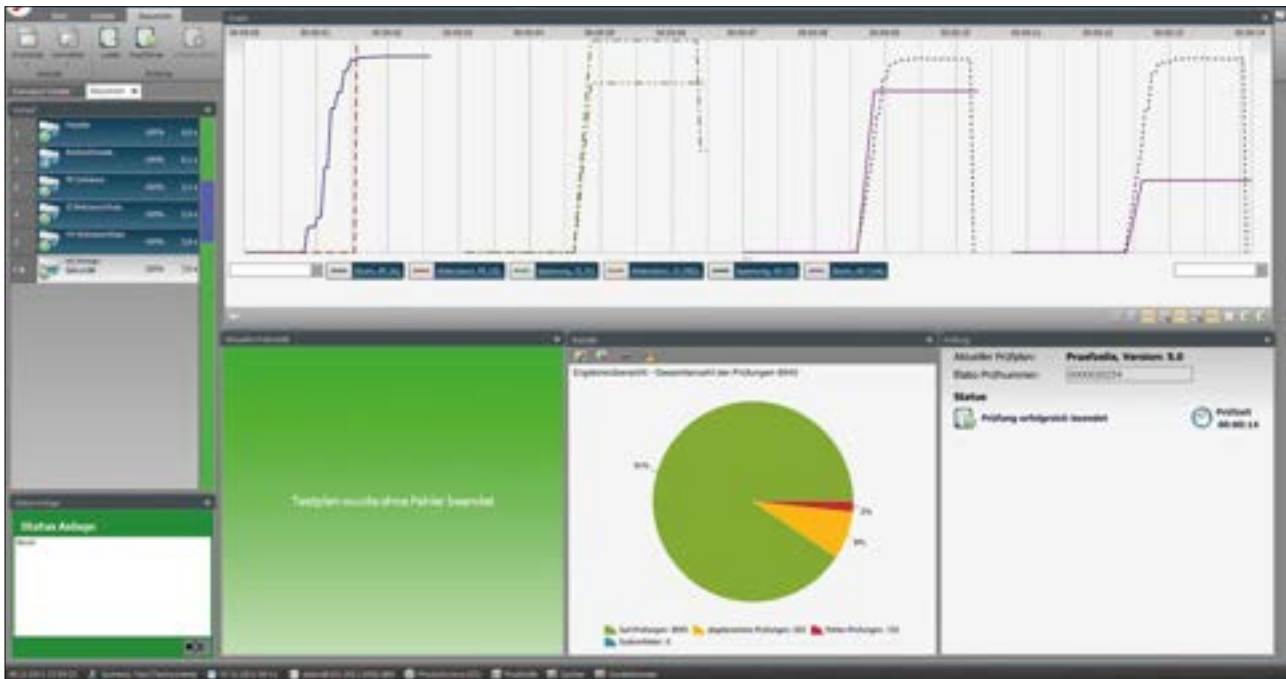

- Sequential test sequence
- Statistics
- Graphic display

Features

1. Chronological, graphic display of the test sequence
2. Permanent display of the current measured values and limit values
3. Permanent logging of all values and storage in the SQL database
4. Showing of instructions
5. Colored display of history with defect identification

Functions

- Selection of test plans (manually, automatically)
- Fully automatic test sequence
- Status and error reports
- Display of all current results
- Identification of test object (manually, bar code, RFID)
- Visualization of all parameters
- Display of all GOOD/FAULT statistics
- Storage of measured values in an SQL database (automatically)

ELABO elution suite

elution device

Module: Test plans

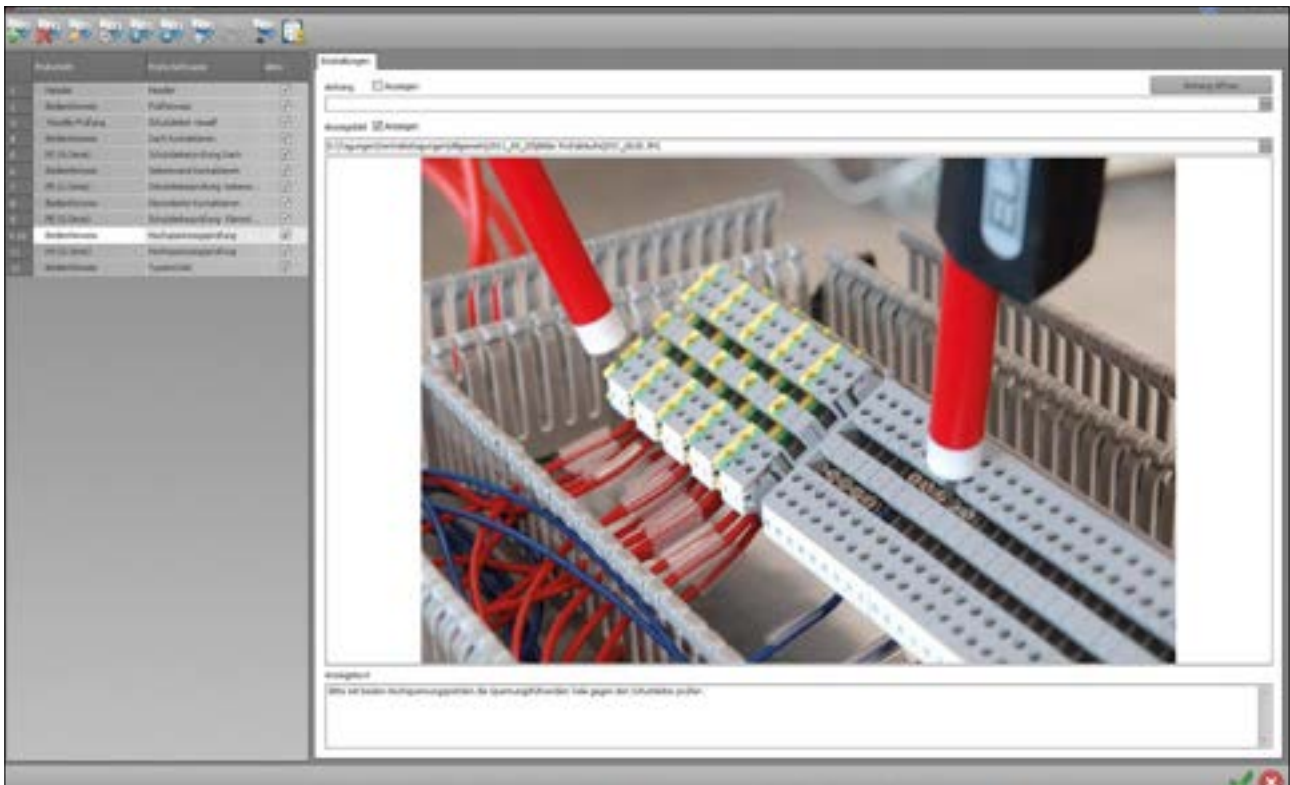

- Preparation of test plans
- Block administration
- Template administration

Features

1. Input of test parameters is in some cases graphically supported
2. Definition of polarity/connection to the test object required for the test step
3. Incorporation of images is possible
4. Full-screen display of all test results, also as a chart

Functions

- Input of basic settings such as test setup, description part, test object identifiers for automatic selection of a test plan
- Input and parameterization of test steps such as current consumption or required voltage
- Incorporation into parameterization of user instructions/visual test steps/wait steps
- Determination of the sequence of the inputted test steps
- Programming of voltage steps and voltage curves for circuit analysis
- Programming of automated measurement routines

ELABO elution suite

elution device

Module: Results & Reports

Prüfnummer	Prüfgerätenummer	Geräte	Ergebnis	Startdatum	Enddatum	Prüfzeit [s]	Prüfkitznummer	Kundenreferenznummer	Ergebnisfarbe
000001040	Leistungsleitbalk_S	S4	abgebrochen	18.11.2011 14:31:02	18.11.2011 14:57:49	460			Cancelled
000001190	Leistungsleitbalk_S	S4	abgebrochen	18.11.2011 12:24:02	18.11.2011 14:24:02	701			Cancelled
000001190	Leistungsleitbalk_S	S4	abgebrochen	18.11.2011 12:23:02	18.11.2011 12:24:02	33			Cancelled
000001220	Leistungsleitbalk_S	S4	abgebrochen	18.11.2011 11:55:20	18.11.2011 12:25:08	1794			Cancelled
000001990	Leistungsleitbalk_S	S4	abgebrochen	18.11.2011 11:29:07	18.11.2011 11:52:17	1617			Cancelled
000001994	Leistungsleitbalk_S	S4	abgebrochen	18.11.2011 11:29:17	18.11.2011 11:29:18	62			Cancelled
000001990	Leistungsleitbalk_S	S4	Fehler	18.11.2011 11:22:36	18.11.2011 11:25:39	63			Failed
000001990	Leistungsleitbalk_S	S4	abgebrochen	18.11.2011 10:49:38	18.11.2011 11:22:58	1940			Cancelled
000001790	Leistungsleitbalk_S	S4	gut	18.11.2011 10:17:04	18.11.2011 10:18:12	108			Passed
000001810	Leistungsleitbalk_S	S4	gut	18.11.2011 09:54:25	18.11.2011 09:55:20	58			Passed
000001949	Leistungsleitbalk_S	S4	abgebrochen	18.11.2011 09:07:58	18.11.2011 09:34:17	1719			Cancelled
000001918	Leistungsleitbalk_S	S4	gut	18.11.2011 09:07:05	18.11.2011 09:07:05	78			Passed
000001918	Leistungsleitbalk_S	S4	abgebrochen	17.11.2011 17:00:59	17.11.2011 17:37:19	2231			Cancelled
000001919	Leistungsleitbalk_S	S4	gut	17.11.2011 16:58:25	17.11.2011 16:58:26	35			Passed
000001914	Leistungsleitbalk_S	S4	gut	17.11.2011 16:58:19	17.11.2011 16:58:21	711			Passed
000001910	Leistungsleitbalk_S	S4	Fehler	17.11.2011 16:42:08	17.11.2011 16:48:05	178			Failed
000001940	Leistungsleitbalk_S	S4	abgebrochen	17.11.2011 16:32:35	17.11.2011 16:40:23	428			Cancelled
000001930	Leistungsleitbalk_S	S4	gut	17.11.2011 16:09:01	17.11.2011 16:10:17	87			Passed
000001940	Leistungsleitbalk_S	S4	abgebrochen	18.11.2011 17:03:02	18.11.2011 17:39:49	348			Cancelled
000001940	Leistungsleitbalk_S	S4	abgebrochen	18.11.2011 17:58:58	18.11.2011 17:52:40	134			Cancelled
000001914	Leistungsleitbalk_S	S4	gut	18.11.2011 17:07:06	18.11.2011 17:10:21	188			Passed
000001917	Leistungsleitbalk_S	S4	gut	18.11.2011 17:09:44	18.11.2011 17:10:10	76			Passed
000001949	Leistungsleitbalk_S	S4	gut	18.11.2011 17:01:37	18.11.2011 17:04:28	82			Passed
000001949	Leistungsleitbalk_S	S4	gut	18.11.2011 17:01:39	18.11.2011 17:02:05	490			Passed
000001944	Leistungsleitbalk_S	S4	abgebrochen	18.11.2011 17:02:00	18.11.2011 17:21:06	2108			Cancelled
000001939	Leistungsleitbalk_S	S4	abgebrochen	18.11.2011 17:14:40	18.11.2011 17:33:49	944			Cancelled
000001880	Leistungsleitbalk_S	S4	Fehler	18.11.2011 17:30:59	18.11.2011 17:34:40	223			Failed
000001949	Leistungsleitbalk_S	S4	gut	18.11.2011 17:12:39	18.11.2011 17:18:49	218			Passed
000001938	Leistungsleitbalk_S	S4	abgebrochen	18.11.2011 16:51:30	18.11.2011 16:42:33	1282			Cancelled
000001919	Leistungsleitbalk_S	S4	gut	18.11.2011 17:41:32	18.11.2011 17:45:13	271			Passed

- Measured value browser
- Report printout
- Export function

Features

1. 3 templates for test logs included
2. Database organized by automatically allocating test numbers, also test plans are provided with titles and comments
3. Timeframe for preparation of statistics can be freely selected

Functions

- Subsequent access to all stored test results
- Export of all data, SQL, CSV, text
- Output of setpoint/actual values, test person ID, date stamp, serial number, equipment number
- Preparation of test logs
- Traceability of test results

ELABO elution suite

elution device

Good to know

Convenience assured

It's the end of the working day, and you're not quite finished? With Elabo Elution® that's not a problem. When you start up the computer and the software the next day, you will be exactly at the same point where you left off the day before.

Usefulness assured

For task A you only need device B? Then simply drag the device onto the desktop, close the software and continue working conveniently and easily via remote control. This is ideal if you have other programs open or if you just want to avoid having to adjust the speed all the time.

Security assured

Elabo devices are frequently connected not just to each other but also to other devices, systems and programs. To make sure that you do not lose any data even in an emergency, we have incorporated numerous security mechanisms. Even in the event of a total outage, you can rest assured that your test results will not be lost and you can continue to work locally with peace of mind.

Functionality assured

Elabo not only offers you all the functions of your devices via the software but goes even further when it comes to power supply panels/power supply systems/variable power supply units. Here, for example, you also have arbitrary functionality and pre-settings.

Order number for package N2-1D

Software packages Elution® Device with the modules:

- Interactive Window Sequencer
- Test plans
- Results & reports
- System

Order number for individual device drivers

Device driver for Smart DC	N2-5A	
Device driver for AC source	N2-5D	
Device driver for digital multimeter	N2-5G	
Device driver for frequency generator	N2-5N	
Device driver for BestPerformance	N2-7A	HV device
Device driver for BestPerformance	N2-7B	combi-tester
Device driver for HighPerformance	N2-7D	HV device
Device driver for HighPerformance	N2-7E	combi-tester
Device driver for Device drivers PE / IS / LC	N2-7G	

ELABO elution suite

elution Training

Control and monitoring of classrooms

Modern classrooms are now centrally controlled and monitored. Functions such as two-stage voltage release or the operation of foldaway systems can be easily selected by mouse click for either a single table or entire rooms. The operation of an emergency STOP button is immediately visually indicated.



The Elabo software allows classrooms to be faithfully and realistically reproduced and controlled. At all times, a perfect overview of the individual tables guarantees that instruction can proceed smoothly. The monitors at the individual student workstations can be remotely viewed and, if necessary, the instructor can intervene.

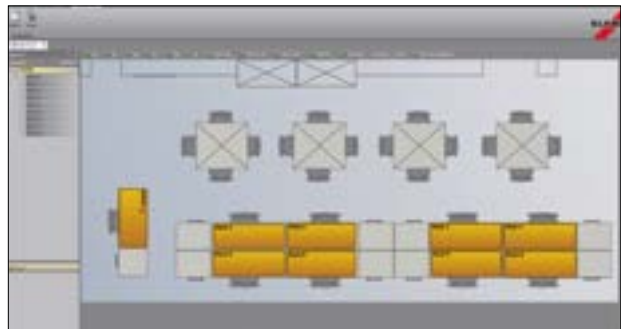

Limitation of devices and organization of experiments

In the course of training, it can perfectly well happen that devices or components become damaged as a result of incorrect wiring or excessively high supply voltages. This is where technology now makes it possible to limit the output power of devices for specific experimental setups. This means that sensitive components remain protected. Also, the devices can be placed under central remote control from the instructor's desk. For example, where necessary, a variable voltage supply can be turned into a fixed voltage source.

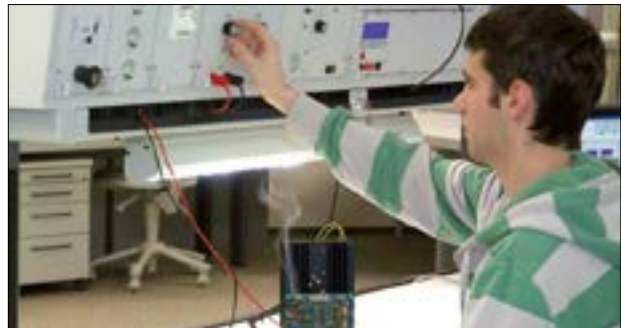

Once they have been created, experimental setups can be selected at any time and sent to the devices in the room. New setups can be created quickly and transparently and distributed through the network to the devices.



ELABO elution suite

elution Training

Measuring like a professional

Why not use the same tools for training as those used by a professional? Modern-day development laboratories employ networked devices and systems. Automated series of measurements and circuit analyses, combined with continuous documentation, facilitate the functional checking of components and circuits.



Direct input of setpoint values, graphic display of actual values and programming of voltage curves are just a few of the highlights offered by the Elabo software. All networked devices can be represented and controlled by dragging and dropping on the monitor.



Structured preparation and documentation of measurement sequences

Automated quality assurance with complete documentation provides the guarantee of product quality in industry. With just a few mouse clicks, simple measurement sequences can be generated and automatically executed. The existing devices can be used as measuring devices.



Laboratory experiments for the determination of component characteristics can be easily prepared and executed. The result includes the prepared measurement sequence and the achieved measured values.



ELABO elution suite

elution training

Available devices

Elabo offers a wide range of networkable devices.

AC power supplies, 1- and 3-phase

DC-stabilizers, 1x and 2x

Digital multimeters

Function generators

I/O modules



System environment

The Elution® software is designed for use with Windows 7 and XP operating systems.

The data are stored in an SQL database, from where data can be exported at any time.

Software package

Elabo software package for vocational training.

The package contains the following modules:

- Interactive Window Sequencer
- Multimode Room (instructor's version only)
- Measured value printout
- User administration and configuration

Order number: N2-4T.S Site license

N2-4T.L Instructor's license for installation on an instructor's computer

Network modules

Technical data

Description		Order no.	
Assembly integration 		Assembly integration Basic - 8-way switch industry standard - power supply unit - cable set for installation in the Elabo assembly	N3-1A
Assembly integration 		Assembly integration 8x10/100/1000Base-T - 8-way switch with holder - power supply unit - patch cable 3 m - cable set for installation in the Elabo assembly	N3-1D
Assembly integration 		Assembly integration with optical fibre waveguide technology - 6-way gigabit Ethernet switch with 2x SFP LWL modules Multimode LC - power supply unit - cable set for installation in the Elabo assembly	N3-1L
Assembly integration 		Assembly integration with VLAN - 8-way switch for VLAN industry standard - power supply unit - cable set for installation in the Elabo assembly	N3-1V
Assembly integration 		Assembly integration with WLAN - Access point - 8-way switch including WLAN - power supply unit - cable set for installation in the Elabo assembly	N3-1W
Duplex patch cable Optical fibre waveguide 		LWL duplex patch cable 2 x 1G50/125µm, mini Plug on both sides, each LC/PC dx Casing colour orange Lenth 5 m Lenth 7,5 m Lenth 10 m Lenth 12 m Lenth 15 m Lenth 23 m	N3-1K Z05M N3-1K Z075M N3-1K Z10M N3-1K Z12M N3-1K Z15 M N3-1K Z23 M

If racks and network equipment are ordered at the same time, then the networking is preinstalled, which means that it then only needs to be connected to the PC. However, customers also have the option of carrying out the assembly integration themselves – e.g. if they already have Elabo racks.

System 3HU



Table of contents

G2.1 Security and protection modules	229
G2.2 AC power supply fixed	234
G2.3 AC power supply, adjustable	237
G2.4 DC-Power supply, fixed	243
G2.5 DC-Power supply, adjustable	246
G2.6 Measuring- and signal devices	259
G2.7 Insulation resistance	
measuring devices	273
G2.8 PE conductor resistance	
measuring devices	281
G2.9 Pneumatics	289
G2.10 Decades & logades	293
G2.11 Interfaces	295
G2.12 Soldering station	299
G2.13 Housing and accessories	303

G2

The logo consists of the letters '3HU' in a white, sans-serif font, centered within a solid grey square.

Security and protection modules

G2.1

System overview 3HU

All modules belonging to the Elabo eurocassette system have a uniform front panel height of 3HU = 128.5 mm. The equipment components comprise insert panels or cassettes for which the width is given in horizontal pitch = HP.



Installation variants

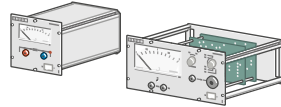

3HU-eurocassettes



System 3HU housing

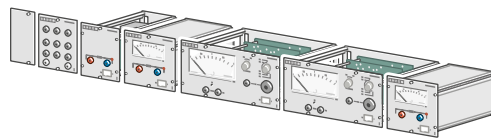

3HU eurocassettes and insert panels

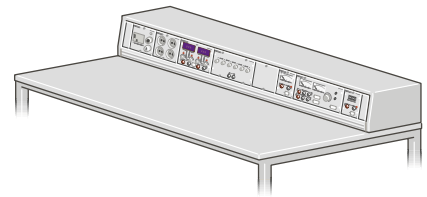

System 3HU bench rack

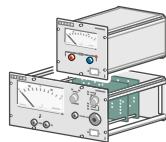

3HU eurocassettes

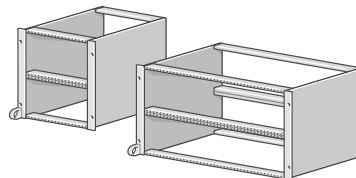

6HU system subrack

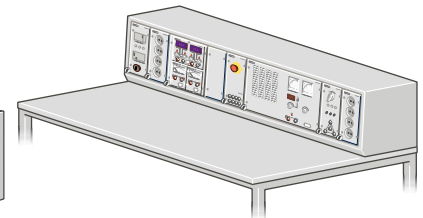

System 6HU bench rack

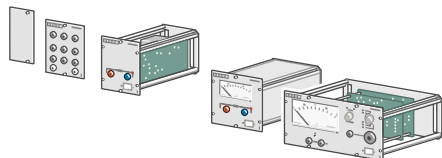

3HU eurocassettes and insert panels

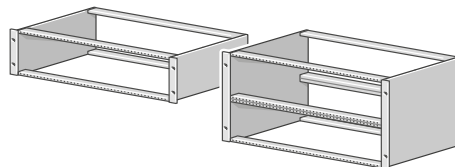

19" system subrack

Technical information

System 3HU modules

Dimensions according to DIN 41494
1 high unit = 1 HU = 44.45 mm.
The width is determined in pitches:

4HP	=	20,3 mm
6HP	=	30,4 mm
8HP	=	40,3 mm
12HP	=	60,9 mm
18HP	=	91,4 mm
24HP	=	121,9 mm
36HP	=	182,9 mm
42HP	=	213,3 mm
48HP	=	243,8 mm
52HP	=	264,1 mm
60HP	=	304,4 mm
66HP	=	334,8 mm

Front panels:

The front panels are manufactured from 3 mm thick hardened aluminium, powder finish, colour "light grey" (similar to RAL 7035). The labeling is screen printed. Fixed panels carry simple components for which a subdrawer construction is not required. Euro-Subdrawers are equipped with 4 sectional panels rails as well as rear panel and an 11-pole multiple connector to DIN 41612. There are also completely closed subdrawers available.

Subracks:

Subracks are required in order to mount fixed panels, subdrawers or other system compatible plug-in assemblies in the back uprights of the system 6HU and 19".

It is also possible to integrate modules of other manufacturers, providing they are made according to the DIN 41494 standard.











Central protection- and release module







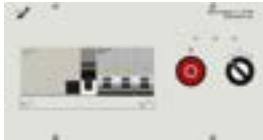



Elabo mains panels are used to turn the central power supply on and off and provide protection for bench racks. They may be mounted in any convenient location in the bench rack but are normally fitted on the left side. All cassettes and insert panels are fitted at the factory and are wired ready for operation.



Technical data

Description			Order no.
<p>Mains supply panel 3HU / 24HP</p>  <p>Fits into 3HU alu-channel</p> <p>1~phase</p>		<p>Insert panel with</p> <ul style="list-style-type: none"> 1 earth-leakage circuit breaker type A 2-pole 25 A / 30 mA 1 Automatic circuit breaker 16 A 1 exterior control indicator lamps 1 Off button 1 key-operated On button 1 predictor 	42-0B
<p>Mains supply panel 3HU / 36HP</p>  <p>Fits into 3HU alu-channel</p> <p>1~phase</p>		<p>Insert panel with</p> <ul style="list-style-type: none"> 1 earth-leakage circuit breaker type B 25 A / 30 mA 1 Automatic circuit breaker 16 A 1 key-operated On button 1 Off button 1 contactor 1 phase indicator lamp 	42-0C
<p>Mains supply panel 3HU / 24HP</p>  <p>Fits into 3HU alu-channel</p> <p>1~phase</p>		<p>Insert panel with</p> <ul style="list-style-type: none"> 1 earth-leakage circuit breaker type A 2-pole 16 A / 10 mA 1 Automatic circuit breaker 16 A 1 exterior control indicator lamps 1 Off button 1 key-operated On button 1 predictor 	42-0D
<p>Mains supply panel 3HU / 60HP</p>  <p>Fits into 3HU alu-channel</p> <p>3~phase</p>		<p>Insert panel with</p> <ul style="list-style-type: none"> 1 earth-leakage circuit breaker 4pole type A 25 / 30 mA 1 motor protection circuit breaker 10...16 A with undervoltage trip 230 V / 50 Hz 1 key switch I/O 5 safety lab terminals L1, L2, L3, N, PE 1 CEE socket red 16 A 3 phase indicator lamps 	42-0F
		<p>like type 42-0F, but with earth-leakage circuit breaker type B</p>	42-0G
<p>Mains supply panel 3HU / 48HP</p>  <p>Fits into 3HU alu-channel</p> <p>3~phase</p>		<p>Insert panel with</p> <ul style="list-style-type: none"> 1 earth-leakage circuit breaker type A 25 A / 30 mA 1 Automatic circuit breaker 3pole C 16 A 1 key-operated On button 1 Off button 1 predictor 3 exterior control indicator lamps 	42-0H
		<p>like type 42-0H, but with earth-leakage circuit breaker type B</p> <p>Type B, sensitive to universal current, also for plain DC residual currents</p>	42-0J

Technical data

Description		Order no.
Circuit breaker 3HU / 18HP 		Insert panel with 1 earth-leakage circuit breaker type A 2-pole 25 A / 30 mA 42-0K
		like type 42-0K, but earth-leakage circuit breaker type B, 24HP 42-0L
Circuit breaker 3HU / 24HP 		Insert panel with 1 Earth-leakage circuit breaker Type A 4-pole 25 A / 30 mA 42-0M
		like type 42-0M, but earth-leakage circuit breaker type B, sensitive o universal current, also for plain DC residual currents, 24HP 42-0N
Fuse predection and switch panel 3HU / 36HP 		Insert panel with 1 Automatic circuit breaker 1-pole C 16 A 1 key switch I/O/II 1 Off button 2 predectors 1 exterior control indicator lamps 1 signal lamp group I 1 signal lamp group II 42-0 V
Fuse predection and switch panel 3HU / 36HP 		Insert panel with 1 Automatic circuit breaker 3-pole 16 C A 1 key switch I/O/II 1 Off button 2 predectors 3 exterior control indicator lamps 1 signal lamp group I 1 signal lamp group II 42-0W
Emergency off switch 3HU / 12HP 		Insert panel with 1 Emergency off switch red with a yellow signaling, not wired up 44-1J
		like Type 44-1J but with open contact for remote access by Elution software (networking module necessary) 44-1J Z701
		like Type 44-1J but with key shut off switch 44-1J Z702
like Type 44-1J but with second break contact 44-1J Z010		

ESD Monitor

to monitor standard compliant work at the EPA workstation



Technical features

- The daily check of the armband and proper connection of the table grounding will be carried out by the ESD-monitor automatically
- Control of persons grounding by two satellites (left + right)
- Both satellites equipped with park position for armband
- 8 LEDs showing status of monitored components
- Acoustic signal in case of incomplete grounding of a monitored component
- If fault won't be corrected within a specific time slot, table switches off automatically
- Individual colour available

3 HU Insert panel

	Type	Colour	Dimension	
42-0X.3	1 / N / PE	Insert panel light grey	W = 213,3, H = 128,5 mm	42 HP
42-0Y.3	3 / N / PE	Insert panel light grey	W = 264,2, H = 128,5 mm	52 HP

AC power supply fixed













G2.2

AC- and AC/DC-power supply

1-phase fixed

3HU

Technical data

Description		Order no.
AC power supply 1-phase 3HU / 36HP 		Insert panel with 4 Schuko sockets 230 V 1 Schuko Socket with line current filtered 230 V / 4 A (high attenuation) 1 Illuminated rocker switch 44-1K
AC power supply 1-phase 3HU / 24HP 		Insert panel with 4 Schuko sockets like Type 44-1L but sockets Switzerland like Type 44-1L but sockets Denmark like Type 44-1L but sockets France like Type 44-1L but sockets Great Britain like Type 44-1L but sockets US 44-1L 44-1L ZC00 44-1L ZD00 44-1L ZF00 44-1L ZG00 44-1L ZU00
AC power supply 1-phase 3HU / 36HP 		Insert panel with 5 Schuko sockets 1 Illuminated rocker switch 44-1L Z817
AC power supply 1-phase 3HU / 36HP 		Insert panel with low AC voltage floating 230 V / 100 VA 1 Illuminated rocker switch 1 Thermic-magnetic circuit breaker 1 Transformer with separated windings 1 socket like 44-4B, but transformer 230 VA but transformer 460 VA (3HU / 42HP) but transformer 690 VA (3HU / 48HP) 44-4B 44-4B Z302 44-4B Z303 44-4B Z301
AC power supply 1-phase 3HU / 36HP 		Insert panel with low AC voltage floating 2, 4, 6, 8, 10, 12 V / 10 A 1 Illuminated rocker switch 1 Transformer with separated windings 3 Thermic-magnetic circuit breakers 4 Safety lab terminals 44-4C
		like 44-4C, but with floating small alternating current voltage 6, 12, 18, 24, 36, 42 V / 3 A 44-4D
Safety lab terminals 3HU / 12HP 		Insert panel with Mains supply L / N / PE 3 Safety lab terminals 44-1W

AC power supply

1-and 3-phase fixed

3HU

Technical data

Description			Order no.
AC / DC-power supply 3HU / 24HP		Eurocassette with floating AC low voltage supply 6,12,18, 24, 30, 36 und 42 V / 3 A 1 externally switchable bridge rectifier (B2) 4 thermic-magnetic circuit breakers 9 Safety lab terminals 1 Illuminated rocker switch	44-1B
AC / DC-power supply 3HU / 36HP 		Eurocassette with floating AC low voltage supply 6,12,18, 24, 30, 36 und 42 V / 3 A 1 externally switchable bridge rectifier (B2) 4 thermic-magnetic circuit breakers 9 Safety lab terminals 1 Illuminated rocker switch	44-1B.3Z610
CEE-Socket 3HU / 18HP 		Insert panel with Mains supply 1 / N / PE ~ 50 Hz with 1 CEE-Socket 16 A, blue	44-1L.3Z605
CEE-Socket 3HU / 24HP 		Insert panel with Mains supply 3 / N / PE ~ 50 Hz with 1 CEE-Socket Insert panel with Mains supply 3 / N / PE ~ 50 Hz with 1 CEE-Socket 5 Safety lab terminals L1, L2, L3, N, PE	44-2C 44-2C Z001
Safety lab terminals 3HU / 12HP 		Insert panel with Mains supply 3 / N / PE ~ 50 Hz with 5 Safety lab terminals L1, L2, L3, N, PE	44-1X
AC power supply 3-phase 3HU / 60HP 		Insert panel with three-phase current supply 3~ 10 /173,3 V 5 A 1 Rotary switch I/O 3 Incandescent bulbs 1 Three-phase transformer with microfuses 3 Thermic-magnetic circuit breakers 4 Safety lab terminals	44-4E

3HU











AC power supply, adjustable

G2.3

AC- and AC/DC-power supply 1-phase 1-phasig controllabile

3HU

Technical data

Description			Order no.
AC / DC-power supply 1-phase 3HU / 84HP 		Insert panel 84 HP with direct and alternating current 0..24 V / 4 A ungrounded, Ripple DC 48 %, with analog displays 1 Voltmeter 1 Ammeter 1 Transformer with separated windings 1 Economical variable transformer 1 thermic-magnetic circuit breaker 1 Illuminated rocker switch 2 Safety lab terminals	44-4F
AC power supply 1-phase 3HU / 84HP 		Insert panel with AC grounded 0...260 V / 1 A and current 1 / N / PE ~ 50 Hz 1 Illuminated rocker switch 1 Economical variable transformer 1 thermic-magnetic circuit breaker 3 Safety lab terminals 2 Schuko sockets	44-4K
AC power supply 1-phase 3HU / 84HP 		Insert panel with AC grounded 0...260 V / 1 A and current 1 / N / PE ~ 50 Hz with analog displays 1 Illuminated rocker switch 1 Economical variable transformer 1 thermic-magnetic circuit breaker 1 Voltmeter 1 Ammeter 3 Safety lab terminals 2 Schuko sockets	44-4L
AC / DC-power supply 1-phase 3HU / 84HP 		Insert panel with direct and alternating current grounded 0...260 V / 1 A and current 1 / N / PE ~ 50 Hz 1 Illuminated rocker switch 1 Economical variable transformer 1 thermic-magnetic circuit breaker 6 Safety lab terminals 2 Schuko sockets	44-4M
AC power supply 1-phase 3HU / 76HP 		Insert panel with AC grounded 0...260 V / 2 A and floating low voltage 0...12 V / 12 A, 0...24 V / 6 A with externally wired jumper rectifier 1 Illuminated rocker switch 1 Economical variable transformer 1 Transformer with separated windings 3 thermic-magnetic circuit breaker 10 Safety lab terminals 1 Jumper rectifier	44-4N





Cassette for AC and AC / DC-power supply

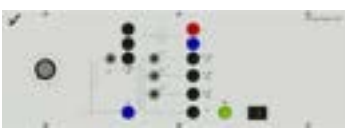

1-phasing controllable

Elabo cassettes can supply direct and alternating voltage to laboratory and test bay equipment. The voltage is set on a variable toroidal transformer via a Rotary knob with 100% scale. Analogue moving-iron instruments with root-mean-square indication are fitted.





Technical data

Description			Order no.
AC power supply 1-phase 3HU / 76HP 		Insert panel with AC grounded 0...260 V / 2 A and low voltage grounded supply 0...6 V / 15 A, 0...18 V / 6 A, 0...42 V / 3 A switchable external jumper rectifier 1 Illuminated rocker switch 1 Economical variable transformer 1 Transformer with separated windings 4 thermic-magnetic circuit breakers 11 Safety lab terminals 1 Jumper rectifier	44-4P
Adjustable AC power supply 3HU / 36HP		Eurocassette with floating, adjustable alternating current voltage 0...260 V / 0,8 A 1 analogue Voltmeter 0...300 V 1 analogue Ammeter 0...1 A 1 thermic-magnetic circuit breakers 1 Shock-proof socket 1 Illuminated rocker switch	44-1D
Adjustable AC / DC-power supply 3HU / 36HP		Eurocassette with floating alternating current voltage 0...260 V / 0,8 A, selectable to DC voltage 0... 260 V / 0,8 A, RW 48 % 1 Voltmeter 0...300 V 1 Ammeter 0...1 A 1 Rocker Switch 1 thermic-magnetic circuit breaker 2 Safety lab terminals 1 Illuminated rocker switch	44-1E
Adjustable AC / DC-power supply 3HU / 36HP		Eurocassette with floating alternating current voltage 0...30 V / 4 A, selectable to DC voltage 0...30 V / 4 A, RW 48 % 1 Voltmeter 0...30 V 1 Ammeter 0...4 A 1 Rocker Switch 1 thermic-magnetic circuit breaker 2 Safety lab terminals 1 Illuminated rocker switch	44-1G
Adjustable AC power supply 3HU / 52HP		Eurocassette with floating, adjustable alternating current voltage 0...260 V / 3 A Load: 0...3 A, transient 4 A over the complete setting range 1 analogue Voltmeter 0...300 V 1 analogue Ammeter 0...4 A 1 thermic-magnetic circuit breaker 1 Shock-proof socket 1 Illuminated rocker switch	44-1M

Cassette for AC- and AC/DC-power supply

3HU

Technical data

Description			Order no.
Adjustable AC / DC-power supply 3HU / 36HP		Eurocassette with stepless adjustable AC and DC 0...260 V / 2 A not floating 0... 42 V / 3 A floating 0... 18 V / 6 A floating 0... 6 V / 15 A floating 1 separate bridge rectifier (B2) 4 thermic-magnetic circuit breakers 10 Safety lab terminals 1 Illuminated rocker switch	44-1F
Adjustable AC / DC-power supply 3HU / 52HP		Eurocassette with adjustable floating AC voltage 0...260 V / 3 A or 0...50 V / 10 A switchable to DC with RW 48 % 0...260 V / 3 A bzw. 0...50 V / 10 A 1 Voltmeter 1. Range 0... 300 V 2. Range 0... 50 V 1 Ammeter 1. Range 0... 4 A 2. Range 0... 10 A Additional precaution: when switching from DC to AC or from extra low to low voltage, or vice versa, the load must be disconnected from the safety lab terminals. 2 thermic-magnetic circuit breakers 2 x 3 Safety lab terminals 2 rocker switches 1 Illuminated rocker switch	44-1P
Smart AC Stabilization with follower control 3HU / 66HP 		Eurocassette with floating alternating current voltage 2...260 V / 2A, stabilization by electric motor with follower control. Two illuminated LCD displays. Display shows voltage, current and power. 4 programmable voltage values. Output limitation, password-protected Including ethernet and USB interface.	44-7A

AC power supply 3-phase adjustable

Elabo-cassettes with direct- and alternating current voltage for the supply of devices in labs and test bay. Voltage adjustment via toroidal variable transformer with turning knob, analog moving iron instruments with RMS display.



Technical data

Description	Order no.
<p data-bbox="118 427 427 483">AC power supply 3-phase 3HU / 66HP</p>  <p data-bbox="836 427 1292 804">Eurocassette with not floating three phase voltage 0...400 V / 3 A with analogue displays 1 illuminated push button 3 External conductor indicator lamps 1 Three-phase toroidal with variable transformer with autowindings 3 Thermic-magnetic circuit breakers 1-pole 3 A 1 Three-phase voltmeter 0...400 V class 2,5 1 Voltmeter switch 1 Moving iron ammeter 0...4 A Klasse 2,5 1 Ammeter switch 5 Safety lab terminals</p>	<p data-bbox="1342 427 1410 450">44-1R</p>

G Electronics



System 3HU

3HU

DC-Power supply, fixed









G2.4

DC-Power supply fixed

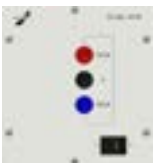
Elabo provides also a wide product range in power supply units.

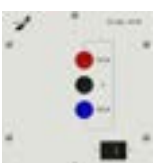
3HU



Technical data

Description		Order no.
DC stabilizer 3HU / 24HP 		Insert panel DC stabilizer in switching regulator version Transient time: maximum 500 μ s 2-3 safety lab terminals 1 Illuminated rocker switch voltage / current Residual ripple 5 V / 5 A 80 mVp-p
DC stabilizer 3HU / 24HP 		Insert panel DC stabilizer in switching regulator version Output voltages ± 15 V / 2 A Output on 3 safety lab terminals Output: 2 x 30 W Residual ripple: 120 mVp-p Voltage tolerance: ± 1.0 % Line regulation: $\pm 0,5$ % Load regulation: $\pm 0,5$ % overload protection
DC stabilizer 3HU / 24HP 		Insert panel with switching power supply with clocked output voltages ± 12 V / 3 A Output on 3 safety lab terminals Specification: Output: 2 x 36 W Residual ripple: 120 mVp-p Voltage tolerance: ± 1.0 % Line regulation: ± 0.5 % Line regulation: ± 0.5 % Overload protection : Hiccup mode
DC stabilizer 3HU / 24HP		Insert panel DC stabilizer in switching regulator version Transient time: maximum 500 μ s 3 Safety lab terminals 1 Illuminated rocker switch 24 V / 6 A 150 Vp-p Note: Can't be mounted into 3HU alu channel
DC stabilizer 3HU / 42HP 		Insert panel with clocked output voltage 24 V / 6 A outputs to 2 safety lab terminals Rated power: 150 W Residual ripple: 150 mVp-p Voltage tolerance: ± 1.0 % Line regulation: $\pm 0,5$ % Load regulation: $\pm 0,5$ % Overload protection

Regulated DC power supplies with stabilization byzed DC output in voltage and current regulated versions. Fixed output supplies for logic circuits, microprocessors and peripheral module s include up to four different sources. The outputs are galvanically isolated and floating.

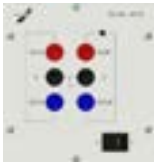

Technical data

Description			Order no.
DC stabilizer 3HU / 18HP		Eurocassette with DC stabilizer with fixed voltage output Ripple of output voltage: < 5 mV Transient time: 100 µs Load smoothing: 0,1 % Temperature coefficient: 0,01 %/°C 2 Safety lab terminals 1 Illuminated rocker switch Voltage / Current 5 V / 3 A	45-1A
DC stabilizer for microprocessors 3HU / 24HP		Eurocassette with DC stabilizer for generating all needed voltages for microprocessors and peripheral modules: All supplies are equipped with a fixed voltage limitation and a voltage surge predection (OVP). Rest Ripple of output voltage: < 20 mV Transient time: ca. 100 µs 6 Safety lab terminals 1 Illuminated rocker switch 1: + 5 V / 5 A, floating, galvanically isolated from output terminals 3 and 4 2: -5 V / 0,5 A, floating 3: +12 V / 1 A, floating 4: -12 V / 1 A, floating	45-1G
DC stabilizer for microprocessors 3HU / 24HP		like Type 45-1G, but with voltage / current 1: +5 V / 5 A, floating, galvanically isolated from output terminals 3 and 4 2: -5 V / 0,5 A, floating 3: +15 V / 1 A, floating 4: -15 V / 1 A, floating	45-1H
DC stabilizer 3HU / 18HP		Eurocassette with DC stabilizer with fixed voltage output Ripple of output voltage: < 5 mV Transient time: 100 µs Load stabilization byzation: 0,1 % Temperature coefficient: 0,01 %/°C 2 Safety lab terminals 1 Illuminated rocker switch Voltage / Current 24 V / 2,5 A (24HP)	45-2M

3HU

DC-Power supply, adjustable

G2.5

Smart DC Lab Power Supply Systems

with arbitrary function

3HU



Highlights

- Master-slave operation
- Parallel operation (0–4A)
- Serial operation (0–60V)
- Tracking operation ($\pm 30V$)
- Predefined curve progressions for sine, square, triangle, sawtooth, PWM
- Arbitrary function for free programming of voltage and current progressions
- Output limitation, password-protected
- Predefinable power-ON values
- Ethernet and USB interfaces
- Integrated web server for simple remote control via web browser
- 1 or 2 channels

Smart DC Lab Power Supply Systems

with arbitrary function

3HU

3 control concepts



Automatic version



Rotary switch version



Touch version

Operating modes

The different operating modes of dual-output power supply units offer the option to control the output voltage of Part 2 as a function (0–100%) of Part 1 while complying with all control characteristics. Output voltage in serial and parallel operation is drawn from the left channel.

- Master-slave operation
Both power modules are electrically isolated from one another, but are controlled together.
- Parallel operation
Both power modules are connected internally in parallel, so that the double output current can be drawn from the output terminals of power module 1
- Serial operation
Both power modules are connected internally in series. The double output voltage can be drawn from the respective external terminals.
- Tracking operation
Both power modules are connected internally in series, so that, with reference to the two terminals in the middle, plus (+30V) or minus (–30V) voltage can be drawn.

Power supply unit with measuring function

Elabo power supply units, in addition to supplying power, are also perfectly suited for the accurate measurement of actual values. Current and voltage values are measured at intervals of 50 ms and can be read out on the interface of the device.

Device limitation

Output voltage and output current can be limited via remote control or also in local mode. This is particularly useful in a training environment or for protecting sensitive components. Such settings are password-protected.

Smart DC Lab Power Supply Systems



with arbitrary function

Arbitrary function

The lab power supply units have an arbitrary function that makes it possible to program and execute pre-determined functions or freely definable voltage and power curves.

The following functions can be selected:

- Sine
- Square
- Triangle
- Sawtooth
- PWM



The freely programmable mode makes it possible to program up to 6 curves each with 99 support points. In this mode, one always presets the start value and end value for current and voltage, and also the duration. In the automatic and rotary switch versions, the arbitrary function can be used only via the interface.

Power class	120W	120W	300W	600W
Feature				
Channel	2	2	1	1
Voltage	2x0...30V	2x0...30V	0...30V	0...60V
Current	2x0...2A	2x0...2A	0...10A	0...10A
Size	3HU / 42HP	6HU / 2WU	3HU / 66HP	6HU / 2WU
Version:				
Automatic	45-6R	–	45-6G	–
Digital	45-7R	34-7T	45-7G	34-7L
Touch	45-8R	34-8T	45-8G	34-8L

Smart DC Lab Power Supply System

2x0...30V / 0...2A / 120W



45-6R



45-7R



45-8R

Highlights

- 4 operating modes for master-slave operation/dual output voltage (0–60V)/dual output current (0–4A)/ symmetrical voltage supply ($\pm 30V$)
- Output limitation, password-protected
- Predefinable power-ON values
- Direct and remote control operation in parallel possible
- Interference voltage protection
- Ethernet and USB interfaces
- Integrated web server
- Arbitrary function

Scope of delivery

45-xR.3 Cassette 3HE / 42HP

Accessories:

83-5B ZBL Safety test lead, blue, 100mm
 83-5B ZRT Safety test lead, red, 100mm



Smart DC Lab Power Supply System

2x0...30V / 0...2A / 120W

3HU

Recommended additional products:

N2-1A Elabo software package Elution® Device
 N2-5A Elution® device driver for Smart DC

Voltage	
Output voltage	2 x 0...30V
Adjusting resolution	10mV
Adjusting precision	± 3 digits (typ. ± 2 digits)
Measuring accuracy	0.15% (display ± 3 digits)
Residual ripple	typ. 0,75mV _{eff} max. 1mV _{eff}
Current	
Output current	2 x 0...2A
Adjusting resolution	1 mA
Adjusting precision	± 3 digits (typ. ± 2 digits)
Measuring accuracy	0.15% (display ± 3 digits)
Arbitrary function	
Number of support points	6 x 99 support points
Structure of support points	Start- / stop voltage, start / stop current, time
Predefined curves for	Sine,, triangle, square, sawtooth and more (up to 10Hz)
Operation	Rotary switch version, automatic version: via interface/Elution® software, Touch version: via display
General information	
Regulation	Longitudinal controller with stepwise pre-control
Adjusting resolution	12bit
Protection	Short circuit-proof, thermal overload protection, interference voltage protection
Output insulation	Ungrounded and isolated ± 250 V to ground
Humidity	25–75% rel. humidity
Operating temperature range	0...50°C
Line voltage	230V ± 10%, 49–61Hz
Display	Rotary switch version 2x two-line LCD, blue Touch operation 4.3" x 128 pixels, blue
Interface	Ethernet and USB, RS232 alternative to USB
Degree of protection	Protection class I (EN61010-1)
Power consumption	140W
Cassette dimensions	W = 213.3mm, D = 196.0mm, H = 128.5mm
Weight	5.3kg

Smart DC Laboratory Power Supply System

0...30V / 0...10A / 300W



45-6G



45-7G



45-8G

Highlights

- Output limitation, password-protected
- Display for voltage, current and power
- Predefinable power-ON values
- Direct and remote control operation in parallel possible
- Interference voltage protection
- Ethernet and USB interfaces
- Integrated web server
- Arbitrary function

Scope of delivery

45-xG.3 Cassette 3HU / 66HP

Accessories:

83-5B ZBL Safety test lead, blue, 100mm
83-5B ZRT Safety test lead, red, 100mm

Smart DC Laboratory Power Supply System

0...30V / 0...10A / 300W

Recommended additional products:

N2-1A Elabo software package Elution® Device

N2-5A Elution® device driver for Smart DC

Voltage	
Output voltage	0...30V
Adjusting resolution	10 mV
Adjusting precision	± 3 digits (typ. ± 2 digits)
Measuring accuracy	0.15% (display ± 3 digits)
Residual ripple	<2mV _{eff}
Current	
Output current	0...10A
Adjusting resolution	10mA
Adjusting precision	± 3 digits (typ. ± 2 digits)
Measuring accuracy	0.15% (display ± 3 digits)
Residual ripple	< 1mA _{eff}
Arbitrary function	
Number of support points	6 x 99 support points
Structure of support points	Start / stop voltage, start / stop current, time
Predefined curves for	Sine, triangle, square, sawtooth and more (up to 10Hz)
Operation	Rotary switch version, automatic version: via interface/Elution® software, Touch version: via display
General information	
Regulation	Longitudinal controller with stepwise pre-control
Stability over 8 hours	0,3 %
Adjusting resolution	12 bit
Protection	Short circuit-proof, thermal overload protection, interference voltage protection
Output insulation	Ungrounded and isolated ± 250V to ground
Humidity	25 - 75% relative humidity
Operating temperature range	0...50°C
Line voltage	230 V ± 10%, 49 - 61Hz
Display	Rotary switch version 2 x two-line LCD, blue Touch operation 4.3" x 128 pixels, blue
Interface	Ethernet and USB, RS232 alternative to USB
Degree of protection	Protection class I (EN61010-1)
Power consumption	345 W
Cassette dimensions	W = 334.8 mm, D = 196.0 mm, H = 128.5 mm
Weight	12.7kg

Smart DC Laboratory Power Supply System

0...60 V / 0...10 A / 300 W



45-6K



45-7K



45-8K

Highlights

- Output limitation, password-protected
- Display for voltage, current and power
- Predefinable power-ON values
- Direct and remote control operation in parallel possible
- Interference voltage protection
- Ethernet and USB interfaces
- Integrated web server
- Arbitrary function

Scope of delivery

45-xG.3 Cassette 3HU / 66HP

Accessories:

83-5B ZBL Safety test lead, blue, 100mm
83-5B ZRT Safety test lead, red, 100mm



Smart DC Laboratory Power Supply System

0...30 V / 0...10 A / 300 W

Recommended additional products:

N2-1A Elabo software package Elution® Device

N2-5A Elution® device driver for Smart DC

Voltage	
Output voltage	0...30V
Adjusting resolution	10mV
Adjusting precision	± 3 digits (typ. ± 2 digits)
Measuring accuracy	0.15% (display ± 3 digits)
Residual ripple	<2mV _{eff}
Current	
Output current	0...10A
Adjusting resolution	10mA
Adjusting precision	± 3 digits (typ. ± 2 digits)
Measuring accuracy	0.15% (display ± 3 digits)
Residual ripple	< 1mA _{eff}
Arbitrary function	
Number of support points	6x99 support points
Structure of support points	Start/stop voltage, start/stop current, time
Predefined curves for	Sine, triangle, square, sawtooth and more (up to 10Hz)
Operation	Rotary switch version, automatic version: via interface/Elution® software, Touch version: via display
General information	
Regulation	Longitudinal controller with stepwise pre-control
Stability over 8 hours	0,3 %
Adjusting resolution	12 bit
Protection	Short circuit-proof, thermal overload protection, interference voltage protection
Output insulation	Ungrounded and isolated ± 250V to ground
Humidity	25 - 75% relative humidity
Operating temperature range	0...50°C
Line voltage	230 V ± 10 %, 49–61 Hz
Display	Rotary switch version 2x two-line LCD, blue Touch operation 4.3" x 128 pixels, blue
Interface	Ethernet and USB, RS232 alternative to USB
Degree of protection	Protection class I (EN61010-1)
Power consumption	345 W
Cassette dimensions	W =334.8 mm, D =196.0 mm, H =128.5 mm
Weight	12,8 kg



Highlights

- Mikroprocessor controlled
- Output power ratings: 100 W, 160 W oder 320 W
- Output voltages: 0...42V oder 0...84 V
- convection or fan cooling
- Four-digi display for voltage and current
- Supports ModBus RTU and SCPI

Art.No.	2002EA-PS2042-06B	2002EA-PS2042-10B	2002EA-PS2042-20B	2002EA-PS2084-05B	2002EA-PS2084-10B
Output voltage	0...42 V	0...42V	0...42V	0...84V	0...84V
Ripple	<100 mV _{PP} <4 mV _{RMS}	<63 mV _{PP} <5 mV _{RMS}	<150 mV _{PP} <2 mV _{RMS}	<96 mV _{PP} <24 mV _{RMS}	<150 mV _{PP} <2 mV _{RMS}
Output current	0...6A	0...10A	0...20A	0...5A	0...10A
Ripple	<100 mA _{PP} <4 mA _{RMS}	<13 mA _{PP} <5 mA _{RMS}	<15 mA _{PP} <6 mA _{RMS}	<9 mA _{PP} <3 mA _{RMS}	<3,8 mA _{PP} <1,4 mA _{RMS}
Output power	100 W	160 W	320 W	160 W	320 W
Cooling	Natural convection	Natural convection	Fan	Natural convection	Fan
Dimensions (WxHxD)	174x82x240 mm	174x82x240 mm	174x82x320 mm	174x82x240 mm	174x82x320 mm
Weight	1.9kg	2kg	2.3kg	2kg	2.3kg
plug in module 3HU	45-00.3EBS-20XX				



Highlights

- Mikroprocessor controlled
- Output power ratings: 212 W oder 332 W
- Output voltages: 0...42V oder 0...84 V
- convection or fan cooling
- Four-digi display for voltage and current
- Supports ModBus RTU and SCPI









Art. No.	2002EA-PS2342-06B	2002EA-PS2342-10B
Output voltage	Output 1+2: 0...42V Output 3: 3...6V	Output 1+2: 0...42V Output 3: 3...6V
Ripple	<100 mV _{pp} / <4 mV _{RMS}	<63 mV _{pp} / <5 mV _{RMS}
Output current DC	Output 1+2: 0...6V Output 3: max. 4A	Output 1+2: 0...10V Output 3: max. 4A
Ripple output 1+2	<10 mA _{pp} / <4 mA _{RMS}	<13 mA _{pp} / <5 mA _{RMS}
Output power	2x100W+1x12W	2x160W+1x12W
Cooling	Fanless, natural convection	
Weight (WxHxD)	Gehäuse 282x/2x243 mm	
Weight	3.8 kg	4 kg
plug in module 3HU	45-00.3EBS-23XX	

Insert panel DC-power supply adjustable

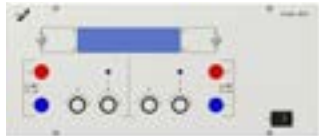
Elabo offers a wide range of products, not only in testing devices and meters but also in power supply systems.



Technical data

Description		Order no.	
<p>Adjustable DC stabilizer 3HU / 60HP</p> 		<p>Insert panel with DC stabilizer 0...30V / 0...1,5 A</p> <ul style="list-style-type: none"> 1 Digital display V/A switch-selected 2 10-turn potentiometers 	45-5F
<p>Adjustable DC stabilizer 3HU / 60HP</p> 		<p>Insert panel with DC stabilizer</p> <ul style="list-style-type: none"> 2 x 0...30 V / 0...1 A 2 Voltmeter and ammeter, digital 2 x 2 10-turn potentiometers 	45-5U
<p>Adjustable DC stabilizer 3HU / 84HP</p> 		<p>Insert panel with DC stabilizer 0...30V / 0...3 A</p> <ul style="list-style-type: none"> 2 Digital displays 2 10-turn potentiometers 	45-5G
<p>Adjustable DC stabilizer 3HU / 84HP</p>  		<p>Insert panel with DC stabilizer</p> <ul style="list-style-type: none"> 2 x 0...30 V / 0...2 A 2 Digital display, switch-selected 2 presets for voltage limitation and current limitation voltage and current are continuously adjustable 2 x 2 10-turn potentiometers 2 Rocker pushbutton switch for output on/off <p>Option: Ethernet Interface 2-fach</p>	<p>45-5U Z801</p> <p>N3-4Q Z102</p>

Technical data

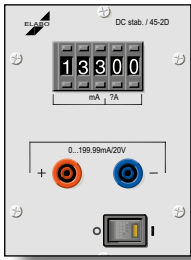
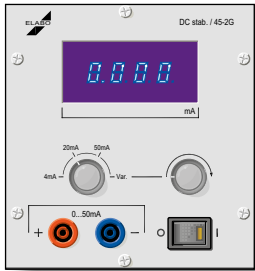
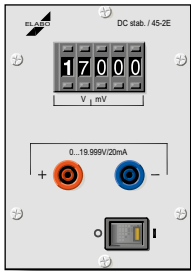
Description			Order no.
Stabilised power source 3HU / 18HP		Insert panel for drawing constant current Current range: 0...199.99 mA Resolution: 10 μ A Setting: with 4½-digit digital potentiometer Output voltage swing: maximum 28 V Internal resistance: > 10 M Ω Non-linearity: 0.15 % Temperature coefficient: 100 ppm / K 2 laboratory safety sockets 1 illuminated rocker switch	45-2D
Stabilised power source 3HU / 24HP		Insert panel for drawing constant current in fixed values Current ranges: 4 mA, 20 mA, 50 mA, can be selected via stepping switch Continuously adjustable current adjustment range: 0...50 mA adjustable with ten turn potentiometer Display: 4-digit LED, 11 mm high Resolution with variable operation: 0.1 mA Voltage swing: 20 V Internal resistance: > 5 M Ω Non-linearity: 0.15 % Temperature coefficient: 150 ppm / K Constant current ripple: 0.02 % 2 laboratory safety sockets 1 illuminated rocker switch	45-2G
Stabilised power source 3HU / 18HP		Insert panel for drawing constant voltage. Setting range: 0...19.999 V Resolution: 1 mV Setting: with 4½-digit digital potentiometer Output current: maximum 20 mA Short-circuit current: 40 mA Internal resistance: > 3 Ω Non-linearity: 0.15 % Temperature coefficient: 50 ppm / K Load control: 0.015 % Ripple: maximum 0.3 mV 2 laboratory safety sockets 1 illuminated rocker switch	45-2E

G Electronics





System 3HU



Measuring- and signal devices

G2.6

Technical data

Description		Order no.
<p>Digital-multimeter 3HU / 24HP</p>  		<p>Insert panel with 5½ digit digitalmultimeter Display: LC with blue background lighting</p> <p>DC voltage measuring Range: 0,2 - 2 - 20 - 200 - 1000 V max. Resolution: 0,01 mV (in 200 mV-Range)</p> <p>DC voltage measuring Range: 0,2 - 2 - 20 - 200 - 2000mA - 20A max. Resolution: 0,0001 mA (nm 200 µA-Range)</p> <p>Alternating current voltage measuring Range: 0,2 - 2 - 20 - 200 - 750 V max. Resolution: 0,01 mV (in 200 mV-Range)</p> <p>AC voltage measuring Range: 0,2 - 2 - 20 - 200 - 2000 mA - 20 A max. Resolution: 0,0001 mA (in 200 µA-Range)</p> <p>Resistance measurement Range: 0,2 kΩ–2 kΩ–20 kΩ–200 kΩ–2 MΩ- 20 MΩ max. Resolution: 0,00 1kΩ (in 200 kΩ- Range) max. allowed measuring voltage: 230 V AC</p> <p>Temperature measurement Range -100...+250 (with PT100 probe; please order probe additionally)</p> <p>Frequency measurement Range 0...50 kHz</p> <p>Diode test</p> <p>Range switching: automatic / manual switching basic accuracy: 0,05 %</p> <p>Further specifications on request.</p> <p>Suitable temperature sensor: 42-1S Z41-1N</p> <p>Immersion temperature sensor 42-1U Z41-1N</p> <p>Surface temperature sensor N3-4P Z102</p> <p>Accessories: Measuring leads / test probes / alligator chips etc.</p>

Technical data

Description		Order no.
<p>Multimeter 3HU / 60HP</p>	 <p>Digital - Multimeter Type Keysight 34461A -Interfaces: LXI, USB, GPIB</p> <p>TECHNICAL DATA:</p> <p>Measuring range A/AC: 100 μA - 10 A Measuring range V/AC: 100 mV - 1000 V Measuring range A/DC: 100 μA - 10 A Measuring range V/DC: 100 mV - 1000 V Measuring range Frequency: 3 Hz - 300 kHz Measuring range resistance: 100 Ohm - 100 MOhm</p> <p>General:</p> <p>Operating Temperature -40°...70°C</p> <p>Mains supply 100/120(127)/220(230)/240 ACV \pm10%</p>	<p>41-1H.3-EBS-3446XA</p> <p>41-1H.3-34461A</p>
<p>Multimeter 3HU / 84HP</p> 	 <p>Insert panel with multifunctional display. Brand Janitza for measuring saving and monitoring of electrical values as: voltage, current, frequency, power factor, effective power, apparent power, reactive power, per phase and in total, active power, Cos Phi</p> <p>Measuring accuracy (related to nominal value) Current, Voltage \pm 0,2 %, Leistung \pm 0,5 % Power factor \pm 0,5 %, Energie \pm 0,5 % Frequenz \pm 0,02 Hz (absolut)</p> <p>Design: supply voltage connection and consumer via 2x5 safety lab terminals L1, L2, L3, N, PE; including Ethernet-Interface</p>	<p>41-1H.3Z803</p>

Smart FG Function generator

10 mHz – 20 MHz

3HU



43-1R



Special features for training



A3-6T (Training version)

Elabo Elution Software enables to control remotely and to program one or more devices in the network.

It is possible to adjust or to program each devices, a group of devices or the output signal of each device individually.

In order to prevent adjusted parameters to be read, display can be turned off remotely by software.

Highlights

- Quartz-stabilization byzed DDS function generator
- Signals: Sinus, Square, Triangle, Pulse, DC voltage
- AC output amplitude: 1 mV–20 Vss (no load)
- DC offset voltage: ± 10 V (idle)
- Operating modes: continuous, frequency sweep, amplitude ramp/offset ramp, pulse with module action
- Frequency and event counter
- Trigger/module ation internal/external
- Touch display with blue LED lighting, multilingual
- Ethernet and USB interfaces

Scope of delivery

43-1R / A3-6T

Cassette 3HU / 42HP

Recommended additional products:

N2-1A

Elabo software package Elution® Device

N2-5N

Elution® Device driver function generator

NET

networkable

Smart FG Function generator

10 mHz – 20 MHz

3HU

Signal types	
Sinus	10 mHz - 20 MHz
Square	10 mHz - 20 MHz
Triangle	10 mHz - 1 MHz
Pulse	10 mHz - 1 MHz, Duty cycle 5–95%, Resolution 1%
Frequency resolution	10 mHz ≤ 10 kHz 100 mHz ≤ 100 kHz 1 Hz ≤ 1 MHz 10 Hz ≤ 10 MHz 100 Hz ≤ 20 MHz
Frequency accuracy	25 ppm
AC output amplitude	1 mV – 20 V _{ss} (idle) Resolution: 1 mV ≤ 2,5 V, 2,5 mV > 2,5 V
DC offset voltage	± 10 V (idle) Resolution 1 mV ≤ 2,5 V, 2,5 mV > 2,5 V
Module ations	
Frequency sweep	Internal or external (input: 0–5V), controllable - Adjustment via start/stop frequency and sweep time, linear or logarithmic increments - Sweep individual (trigger: button, external, remotely controlled) or continuous (also with return)
Amplitude ramp (sweep) Offset ramp	Internal or external (input: 0–5V), controllable - Adjustment via start/stop amplitude and sweep time, linear increments - Sweep individual (trigger: button, external, remotely controlled) or continuous (also with return)
Pulse width module ation	Internal or external (input 0–5V), controllable - With internal control: adjustment via lowest/highest duty cycle and sweep time, linear increments - Sweep individual (trigger: button, external, remotely controlled) or continuous (also with return) - With external control: 0 V: 0%–5V: 100% duty cycle, adjustable
Frequency and event counter	
Measuring range	0,1 Hz - 30 MHz
Input voltage	0,5 V _{eff} - 100 V _{eff}
Event counter	Positive edge, switching threshold 1.6V Start, stop, pause, reset

Connections	
Outputs (BNC)	Main OUT: Impedance 50Ω, overvoltage protection, safety cutout TTL OUT: TTL/CMOS level Sync. OUT: TTL/CMOS level
Inputs (BNC)	Trigger IN: TTL/CMOS opto-decoupled, overvoltage protection Module ation IN: 0–5 V input level, overvoltage protection Counter IN: 0–100 V input level, overvoltage protection

Smart FG Function Generator

10 mHz – 20 MHz

3HU

General information	Short circuit protected, thermic overload protection
Stabilization by over 8 hours	0,5 %
Output insulation	Ungrounded and isolated ± 250 V to ground
Humidity	25–75 % rel. humidity
Operating temperature range	0...50 °C
Mains supply	230 V ± 10 %, 49–61 Hz
Display	Touch operation 4,3" 240x128 pixel, blue
Interface	Ethernet and USB, RS232 alternative to USB
Power consumption	40 W
Cassette dimensions	W =213,3 mm, D =196 mm, H = 128,5 mm
Weight	2,2 kg



Signal and modulation					
	Normal mode	Sweep linear	Sweep log.	DC-Offsetramp	Amplitudenramp
Sinus 0,01 mHz – 20 MHz					
Square 0,01 Hz – 20 MHz					
Triangle 0,01 Hz – 1 MHz					
Pulse 0,01 Hz – 1 MHz Tastverh. 5 – 95 %, Aufl. 1 %					
DC					

Function generator

Function generators form a versatile group of equipment useful for applications in low frequency engineering. The wide frequency range and many different output functions also allows tests to be carried out on electrical systems with non-sinusoidal voltage forms.



Technical data





Description		Order no.
<p>Function generator 3HU / 36HP</p>  <p>Fits into 3HU alu-channel</p>		<p>43-1V</p>
<p>Power amplifier 3HU / 24HP</p>		<p>43-1T</p>

PC-Oscilloscope





Oscilloscopes are easy to use and can be operated completely using the software provided. The user can thus take advantage of all of the advantages of the PC, such as large memory capacity and high-quality display. The Windows user interface, means that the device can be operated in the same familiar way as standard applications and programmes.

Technical data

Description		Order no.
<p>2-Channel PC-Oscilloscope 3HU / 52HP</p> 	 <p>Insert panel with PC oscilloscope, including Ethernet interface, manufactured by Metrix Bandwidth: 150MHz, bandwidth filter for 15MHz, 1.5MHz or 5kHz 2 channels, Class 1 Vertical: 2.5mV / div- 100 V / div up to 250iV / div with Yexpansion Time bases: 35 ranges from 1ns/div to 200s/div Horizontal zoom: from x 1 to x 100, sequence 1-2-5 (display of 500 for 10 div) Trigger: Auto; Triggered Single Shot Trigger source: CH1, CH2, EXT, network Type: Slope, Pulse width or Delay (40ns-10.5s), Counting (2-16384 events), TV (525 = NTSC, 625 = PAL/SECAM), Pretrigger adjustable from 0 to 100%, Hold-off (40ns-10.5s) Max. sampling rate: Repeating signals = 100MS/s, Single Shot=200MS/s Vertical resolution: 10bit (9 used) Memory depth: 50,000pts. (memory capacity depends on the PC used) Afterglow duration: 100ms, 200 ms, 500ms, 1s, 2s, 5s, 10s and infinite Acquisition rate: 50 kwaveforms / s / channel Display acquired samples: 19MS / s / channel FFT: calculation across 2048pts.), +, -, x, /- Editor for individual measurement functions Manual cursors: (dv, dt), PHASE and free Automat. measurements: 2-19 measurements of 19 + automatic phase, on all curve types, marker and limiter Sampling duration: from 2 s to 31 days Sampling rate: with intervals from 40µs to 53.57s Extent of analysis: basic speed up to 31st harmonic, in 1 to 2 channels and simultaneous fundamental harmonic oscillation of 40Hz to 1kHz Evaluation: continuous display of RMS value & THD- for selected harmonic: % F, Phase, Freq., VRMS Optionally available: differential voltage probes</p>	<p>41-1Q Z102-EBS 41-1Q Z102-Module</p>
<p>4-Channel Oscilloscope 3HU / 52HP</p> 	 <p>like Type 41-1Q Z102, but 4 channels, Class 1 Trigger source: CH1, CH2, CH3, CH4, EXT, mains</p>	<p>41-1R Z102-EBS 41-1R Z102-Module</p>

Technical data

Description			Order no.
Digital thermometer 3HU / 24HP		Insert panel with digital thermometer for Pt100 / Pt1000 1. Measurement range: -50,0 °C bis + 200,0 °C, Resolution 0,1 °C 2. Measurement range: - 200 °C bis + 850 °C, Resolution 1 °C Equipment: 1 Illuminated rocker switch I/O 1 Digital display 4 digits 1 Diodes connector socket 4-pole	42-1R Z601
Universal Temperature sensor		Pt100 immersion temperature sensor, suitable for the 42-1R.3Z601 Temperature range: - 50°C to + 400°C Length: 150mm Diameter: 3 mm	42-1S
Temperature sensor		Pt100 temperature sensor for gases, suitable for 42-1R.3Z601 Temperature range: - 50°C to + 400°C Length: 100mm Diameter: 3 mm	42-1T
Temperature sensor		Pt100 temperature sensor for surfaces, suitable for 42-1R.3Z601 Temperature range: - 50°C to + 400°C Lenth: 300 mm Diameter: 4 mm	42-1U
PT100-Simulator 3HU / 18HP		Insert panel with PT100-Simulator with 23 fixed temperature values and infinitely variable temperature simulation by trimmer. Values in °C: -100,-50,-30,-20,-10, 0, +10, +20, +30 +50, +70, +90, +100, +120, +140, +150, +170, +190, +200, +250, +300, +400, +600 variabel-40...+200 (82...182 Ohm) Accuracy: ±0,05% Temperature drift: 25ppm/K Load capacity: 0,5W max. Operating temperature: 0...+50°C Humidity 0...95 without dewing Service life: >25000 Switching cycles	42-2P

Technical data

Description		Order no.
<p>Continuity tester 3HU / 12HP</p>	 <p>Eurocassette with continuity tester and for rough testing of resistances, condensers and coils.</p> <p>The pitch of the generator declines as the resistance value of the test item increases. A change can be reliably detected up to several MOhm.</p> <p>Device input: voltage-proof up a maximum of 400 V AC</p> <p>Volume: continuously adjustable via potentiometer up to approx. 100 dB at a distance of 10 cm</p> <ul style="list-style-type: none"> 1 volume controller 2 laboratory safety sockets 1 illuminated rocker switch 	<p>42-1F</p>

Technical data

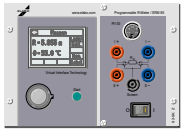
Description			Order no.
<p>Digital resistance tester 3HU / 36HP</p>		<p>Eurocassette with digital resistance tester for single operation in manufacturing, laboratory and receiving inspection as well as for operation in automatic test systems.</p> <p>Technical data: Measurement range: 8 Ranges from 200 mOhm...2 MOhm Display: 4½-digit LED 7-segment-display Measuring currents: 100 mA ...1 µA Measuring errors: 0,1 % v.M., + 0,005 % v.M./K, + 2 digits Fault detection: CURRENT; SENSE; OVERLOAD; POLARITY</p> <p>Temperature reference: 20 °C 4 Safety lab terminals 1 Illuminated rocker switch</p>	<p>90-3K</p>
<p>Digital resistance tester 3HU / 36HP</p>		<p>Eurocassette with digital resistance tester for operation in laboratory, manufacturing and test bay. Tester is equipped with TFT-display.</p> <p>Technical data: Measurement range: 8 Ranges from 200 mOhm...2 MOhm - 50 °C...200 °C Measuring currents: 100 mA ...1 µA Measuring errors: +/- 0,1 % v.M., + 0,05 % v.M./K, + 2 Digits Measurement clock: max. 3/s</p> <p>Memory: 300 Parameter records Interfaces: CAN/RS232 Connection: 5 connector sockets, 1 diode plug</p>	<p>92-5K</p>

I/O-Module

For digital and analog signals

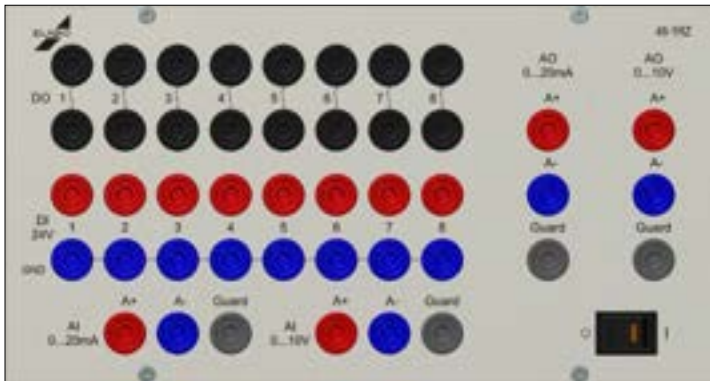

46-1RZ102

Highlights

- The I/O module is the ideal addition to Elabo network technology
- In the compact 3HU / 48HP type, the module can be used in both 3HU and 6HU systems
- It can be easily integrated even in the Elabo 3HU profile channel

Areas of application

Measuring	Remotely controlled switching from various measuring points to a central measuring device
Control	Activation of pneumatic components and reading-in of end positions
Measured data recording	Integration of analog signals in the measurement process and documentation of the result
Actuator control	Actuators with analog input signals can be integrated into measurement processes



I/O-Module

For digital and analog signals

Inputs/outputs

Digital:

8 digitale inputs	DI 1...8	24 V level
8 digitale outputs	DO 1...8	Floating relay contacts, switching capacity 260 V / 2 A

Analog:

1 analog input	AI	0...20mA
1 analog input	AI	0...10V
1 analog output	AO	0...20mA
1 analog output	AO	0...10V

All inputs and outputs routed to 4 mm safety lab sockets.

Functional example

When performing a measuring task, voltages can be measured at three different points using a multimeter. In automated form, without an I/O module this task would be possible only if 3 multimeters were used. With the help of the I/O module, the 3 measuring points can be connected to the multimeter one after the other and the measurements can be automatically recorded.

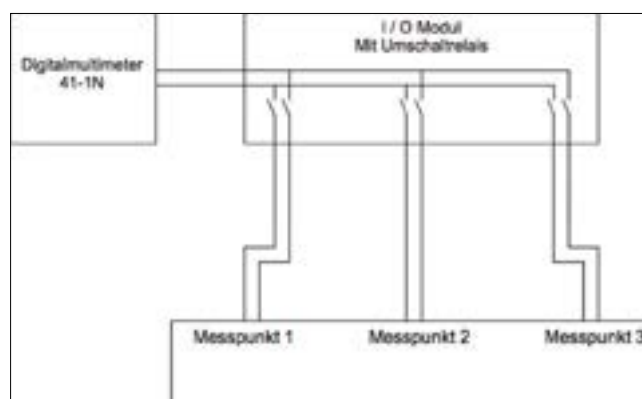

The Elabo I/O module is integrated directly into the extensive Elabo Elution software package. Each input/output can be activated/read in either individually or collectively.

Required additional products:

Software Elution, N2-1A Elution Device,
N2-5R device driver for I/O module



G Electronics



System 3HU

3HU

Insulation resistance measuring devices

G2.7

Insulation resistance measuring devices

High-ohm measuring technology



Why insulation resistance measurement?

Insulation resistance measurement of insulation materials and of electric devices and equipment. Insulation faults can result in leakage current, which can endanger the operator. In particular with devices in protection class II, but also with other protection classes, the test is used to ensure that the measurement results are within the acceptable range. Measurements also play an important role in the performance of repeat tests. The test can also be an important indicator of the quality of the manufacturing process when testing insulation materials (e.g. in the solar industry).

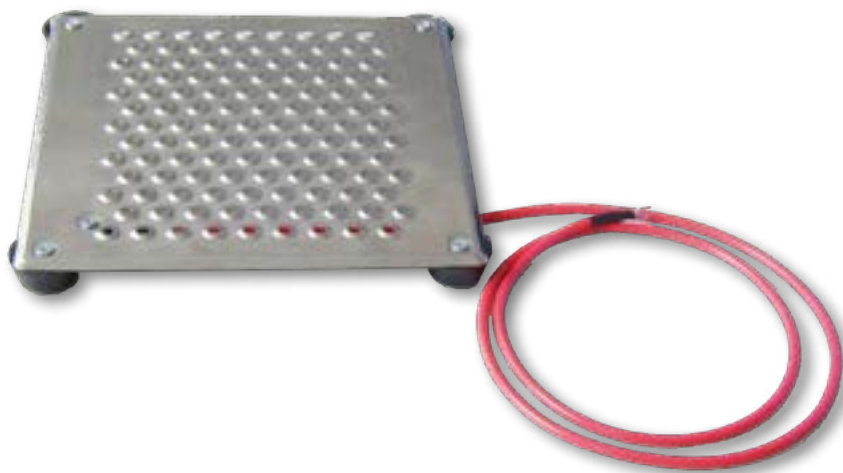

Insulation resistance measurement

Measurement of the insulation resistance assesses the actual effective resistance component of the insulation material. The test current used is generally 500 V DC, and it is applied between active and inactive parts of the test object. Applicable threshold values are usually in the 1 .. 100 M Ω range.

Variation of insulation resistance devices



Device	90-4K	90-2E
--------	-------	-------

Applications		
Manual use	●	●
Automated use	●	●

Operation		
Digital display, 3.5 digits	●	
Analog Display	●	●
Interface Digital		●
Start button	●	●
Potentiometer to set threshold value	●	●
Configurable test voltage (internal)	●	
Configurable measurement range (internal)	●	
Potentiometer to set voltage	●	
Selector for fixed/variable voltage	●	

Interfaces		
Digital interface	●	●
Analog output 0 .. 10 VDC (Measured value)	●	●

Connections		
Socket at front ¹	●	●
Laboratory receptacles at front	●	●
Shielding connection at front	●	
Measurement connections at back	●	●

Testing parameters		
Test voltage 1	50-550 VDC	500 VDC
Test voltage 2	500- 1000 VDC	
Test current	< 12 mA	< 3 mA
Measurement range 1	0 .. 10,00 MΩ	0 .. 10 MΩ
Measurement range 2	0 .. 100,0 MΩ	0 .. 100 MΩ
Measurement range 3	0 .. 1000 MΩ	
Measurement error display	< 3 % v.E.	< 5 % v.E.
Measurement error analog output	< 2 % v.E.	< 2 % v.E.

Principal technical data		
Mains connection	230 V ± 10 %	
Mains frequency	49 - 61 Hz	
Dimensions	3HU / 36HP	
Weight	2,8 kg	1,3 kg
Allowable humidity	25- 75 % rel.	
Working temperature	10- 50 °C	

Insulation resistance measuring devices

90-4K

50...1000 VDC

3HU



Front view 90-4K



Rear view 90-4K

Highlights

- Test voltage 1: 50...550 V / DC
- Test voltage 2: 500...1000 V / DC
- Measurement range: 0...10 / 100 / 1000 MΩ
(internally configurable measurement range 1+2 oder 2+3)
- Test current: <12 mA
- Measurement error display: < 3 % v.E.
- Measurement error analog output: < 2% v.E.
- Mains supply: 230 V +/- 10 %; 49 ... 61 Hz
- Interface: Digital / Analog output
- Dimensions: 3HU / 36HP
- Weight: 2,8 kg
- Allowable humidity: 25 ... 75 % rel.
- Working temperature: 10 ... 50 °C

Optional

- 90-4K E10 Ethernet instead of digital / analog
- 90-4K E11 RS232C instead of digital / analog
- 90-4K E12 USB instead of digital / analog
- 90-4K E99 Delivery with Elabo works calibration protocol

Recommended additional products

- Elabo software package Elution® Device
- Elution® Device driver Single test devices

Insulation resistance measuring devices

90-4K

50...1000 VDC

3HU

Technical data

Applications	
Manual use	•
Automated use	•
Operation	
Digital display, 3.5 digits	•
Interface Digital	•
Start button	•
Potentiometer to set threshold value	•
Configurable test voltage (internal)	•
Configurable measurement range (internal)	•
Potentiometer to set voltage	•
Selector for fixed/variable voltage	•
Interfaces	
Digital interface	•
Analog output 0 .. 10 VDC (measured value)	•
Connections	
Socket at front ¹	•
Laboratory receptacles at front	•
Shielding connection at front	•
Measurement connections at back	•
¹ Schuko socket, other country-specific installation sockets available on request.	

Insulation resistance measuring devices 90-2E

500 V / DC

3HU



Front view 90-2E



Rear view 90-2E

Highlights

- Test voltage: 500 VDC
- Measurement range: 0...10 / 100 MΩ
- Test current: < 3 mA
- Measurement error display: < 5 % v.E.
- Measurement error analog output: < 2% v.E.
- Mains supply: 230 V +/- 10 %; 49 ... 61 Hz
- Interface: Digital / Analog output
- Dimensions: 3HU / 36HP
- Weight: 1,3 kg
- Allowable humidity: 25 ... 75 % rel.
- Working temperature: 10 ... 50 °C

Optional

- 90-2E E10 Ethernet instead of digital / analog
- 90-2E E11 RS232C instead of digital / analog
- 90-2E E12 USB instead of digital / analog
- 90-2E E99 Delivery with Elabo works calibration protocol

Recommended additional products

- Elabo software package Elution® Device
- Elution® Device driver Single test devices

Insulation resistance measuring devices 90-2E

500 V / DC

3HU

Technical data

Applications	
Manual use	•
Automated use	•
Operation	
AnalogDisplay	•
Interface Digital	•
Start button	•
Potentiometer to set threshold value	•
Interfaces	
Digital interface	•
Analog output 0 .. 10 VDC (measured value)	•
Connections	
Socket at front ¹	•
Laboratory receptacles at front	•
Measurement connections at back	•
¹ Schuko socket, other country-specific installation sockets available on request.	

Sample configurations

Requirement:

Portable insulation resistance testing device for use at a test station or as a mobile unit. This example shows a typical configuration for this application.



Description	Quantity	Ordering no.
Insulation resistance measuring device 50 .. 1000 VDC	1	90-4K
Housing	1	30-6M
Calibration	1	90-4K E99

Requirement:

Test system for PE conductor and insulation resistance measurement in a practical portable housing. This unit is also available in a model with combined measurement function. You can find additional useful components such as test sensors and extra blank panels in our accessories program.



Description	Quantity	Ordering no.
Insulation resistance measuring device	1	90-4K
Blank panel	1	40-1A
PE conductor testing device 10 VAC / 10 .. 25 A	1	90-4F
Housing	1	30-6N
Calibration	1	90-4K E99
Calibration	1	90-4F E99

Requirement:

PE conductor testing device for use in automated systems. A 19" module rack allows the installation of a switching cabinet. You can find additional useful components such as test sensors and extra blank panels in our accessories program.

Description	Quantity	Ordering no.
Insulation resistance measuring device 50 .. 1000 VDC	1	90-4K
Subrack unwired	1	94-1R
Blank panel 12HP	1	40-1A
Blank panel 36HP	1	40-1D
Calibration	1	90-4K E99



3HU

PE conductor resistance measuring devices

G2.8

PE conductor resistance measuring devices

Robust building blocks with a high degree of availability

Whether as an individual workstation solution or as a component in a partially or fully automated testing system, in the workshop, the laboratory or in mass production – Elabo testing devices stand out because of their broad, flexible range of applications. Right from the start, the basic models of testing devices are adapted to their respective applications. Using appropriate accessories, they can also be customized at a later date to modified or expanded requirements, such as ongoing automation.

Elabo – long-term reliable solutions in all cases.

Why PE conductor resistance measurement testing?

PE conductor resistance measurement of devices in protection class 1 is one of the most important tests for household, medical and consumer devices as well as in the field of general mechanical engineering and plant engineering and construction. Verification of the efficacy of the protective earth connection between the mains connection and every exposed conductive (generally metal) housing part represents “life insurance” for users of electrical equipment. Only if this connection is 100% guaranteed for the long term the upstream safety element can safely disconnect the device from the power supply in the event of a short circuit to the housing, for instance. Inherent grounding of housing parts also prevents the creation of a dangerous voltage potential between the housing and the ground where the operator stands.



Measurement of PE conductor resistance

The principle of measuring PE conductor resistance in products in protection class 1 is simple to understand. A current is directed from a PELV current source (usually 6 or 12 VAC no-load voltage) from the PE connection to all exposed metal parts. The resistance is determined from the voltage drop and the flowing current. Typical threshold values are between 100 and 200 mW. However, other threshold values are also used depending on the product to be tested. Because of the low test voltage, no additional safety measures are necessary in the PE test.

Variants of PE conductor resistance measuring devices



Device	90-2A	90-2B	90-2C	90-4F	90-4G	90-4E
Applications						
Manual use	●	●	●	●	●	●
Automated use	●	●	●	●	●	●

Operation						
Digital display, 3.5 digits				● R/I	● R/I	● U/I
Analog display, selectable	● R/I	● R/I	● R/I			
Interface	●	●	●	●	●	●
Start button	●	●	●	●	●	●
Reset button	●	●	●			
Potentiometer to set test current				●		
Setting unit to set test current	●	●	●			
Potentiometer to set threshold value	●	●	●	●	●	●

Interfaces						
Digital interface	●	●	●	●	●	●
Analog output 0 .. 10VDC (Measured value)	●	●	●	●	●	●

Connections						
Test sensor at front	●	●	●	●	●	●
Socket at front ¹	●	●	●	●	●	●
Laboratory receptacles at front	●	●	●	●	●	●
Measurement connections at back	●	●	●	●	●	●

Testing parameters						
Test voltage	12 VAC	12 VAC	12 VAC	10 VAC	6 VAC	6 VAC
Test current programmable				10 .. 25 A	25 A	12 A
Test current adjustable	10 .. 25 A	10 .. 30 A	10 .. 50 A			
Measurement range	0 .. 300 mΩ	0 .. 300 mΩ	0 .. 200 mΩ	0 .. 350 mΩ	0 .. 200 mΩ	0 .. 3,5 V
Measurement error display	< 5 % v.E.			1,5 % v.E. / ± 2 digits		
Measurement error analog output	< 2 % v.E.			1,5 % v.E. / ± 2 digits		

Principal technical data						
Mains connection	230 V ± 10 %		230 V + 10 / - 5 %	230 V + 10 / - 5 %		
Mains frequency	49 .. 61 Hz					
Dimensions	3HU / 36HP	3HU / 42HP	19" / 4HU	3HU / 36HP	3HU / 36HP	3HU / 36HP
Weight	6 kg	7 kg	30 kg	6 kg	6 kg	6 kg
Allowable humidity	25 .. 75 % rel.					
Working temperature	10 .. 50 °C					
Test time			1 s .. 99 min			

PE conductor resistance measuring devices 90-2A / 90-2B

12 V / AC



Front view 90-2A



Front view 90-2B

Highlights

- Test voltage: 12 V / AC
- Measurement range: 0...300 mΩ
- Test current 90-2A: 10...25 A
- Test current 90-2B: 10...30 A
- Measurement error display: < 5 % v.E.
- Measurement error analog output:< 2% v.E.
- Mains supply: 230 V +/- 10 %; 49 ... 61 Hz
- Interface: Digital / Analog output
- Allowable humidity: 25 ... 75 % rel.
- Working temperature: 10 ... 50 °C

Optional

- 90-2A E10 / 90-2B E10 Ethernet instead of digital / analog
- 90-2A E11 / 90-2B E11 RS232C instead of digital / analog
- 90-2A E12 / 90-2B E12 USB instead of digital / analog
- 90-2A E99 / 90-2B E99 Delivery with Elabo works calibration protocol

Recommended additional products

- N2-1A Elabo software package Elution® Device
- N2-7G Elution® Device driver single test devices

PE conductor resistance measuring devices 90-2A / 90-2B

12 V / AC

3HU

Technical data

Device	90-2A	90-2B
Applications		
Manual use	•	•
Automated use	•	•
Operation		
Analog display, selectable	• R / I	• R / I
Interface	•	•
Start button	•	•
Reset button	•	•
Setting unit to set test current	•	•
Potentiometer to set threshold value	•	•
Interfaces		
Digital interface	•	•
Analog output 0 .. 10 VDC (measured value)	•	•
Connections		
Test sensor at front	•	•
Socket at front ¹	•	•
Laboratory receptacles at front	•	•
Measurement connections at back	•	•
Principal technical data		
Dimensions	3HU / 36HP	3HU / 42HP
Weight	6 kg	7 kg
¹ Schuko socket, other country-specific installation sockets available on request.		

PE conductor resistance measuring devices 90-4F / 90-4G / 90-4E

10 VAC / 6 VAC

3HU



Front view 90-4F



Front view 90-4G



Rear view 90-4E, 90-4G

Highlights

	90-4F	90-4G	90-4E
· Test voltage:	10 VAC	6 VAC	6 VAC
· Measurement range:	0 ... 350 mΩ	0 ... 200 mΩ	0 ... 3,5 V
· Test current:	10 ... 25 A	25 A	12 A
· Measurement error display:	1,5 % v.E. / +/- 2 digits		
· Measurement error analog output:	1,5 % v.E. / +/- 2 digits		
· Mains supply:	230 V + 10 % / - 5 %; 49 ... 61 Hz		
· Interface:	Digital / Analog output		
· Dimensions:	3HU / 36HP		
· Weight:	6 kg		
· Allowable humidity:	25 ... 75 % rel.		
· Working temperature:	10 ... 50 °C		

Optional

90-4F E10/90-4G E10/90-4E E10	Ethernet instead of digital / analog
90-4F E11/90-4G E11/90-4E E11	RS232C instead of digital / analog
90-4F E12/90-4G E12/90-4E E12	USB instead of digital / analog
90-4F E99/90-4G E99/90-4E E99	Delivery with Elabo works calibration protocol

Recommended additional products

Elabo software package Elution® Device
 Elution® Device driver Single test devices

PE conductor resistance measuring devices 90-4F / 90-4G / 90-4E

10 VAC / 6 VAC

3HU

Technical data

Device	90-4F Universal	90-4G Medical technology	90-4E Voltages (drop) tester
Applications			
Manual use	•	•	•
Automated use	•	•	•
Operation			
Digital display, 3.5 digits selectable	• R / I	• R / I	• U / I
Interface	•	•	•
Start button	•	•	•
Potentiometer to set test current	•		
Potentiometer to set threshold value	•	•	•
Interfaces			
Digital interface	•	•	•
Analog output 0 .. 10 VDC (measured value)	•	•	•
Connections			
Test sensor at front	•	•	•
Socket at front ¹	•	•	•
Laboratory receptacles at front	•	•	•
Measurement connections at back	•	•	•
¹ Schuko socket, other country-specific installation sockets available on request			

Sample configurations

Superior performance in practical applications

Requirement:

Portable PE conductor testing device for use at a test station or as a mobile unit. This example shows a typical configuration for this application.

Description	Quantity	Ordering no.
PE conductor testing device 12 VAC 10 .. 25 A	1	90-4F
Housing	1	30-6M
Test sensor	1	94-4S
Calibration	1	90-4F E99



Requirement:

PE conductor testing device for use in automated systems. A 19"-module rack allows the installation of a switching cabinet. You can find additional useful components such as test sensors and extra blank panels in our accessories program.

Description	Quantity	Ordering no.
PE conductor testing device 25 A	1	90-4G
Module rack with 24-pole system plug	1	94-1R
Blank panel 12HP	1	40-1A
Blank panel 36HP	1	40-1D
Calibration	1	90-4G E99



Requirement:

Test system for combined PE conductor and insulation resistance measurement in a practical portable housing. This unit is also available in a model with separate measurement functions. You can find additional useful components such as test sensors and extra blank panels in our accessories program.

Description	Quantity	Ordering no.
PE conductor testing device 12 VAC 10 .. 25 A	1	90-2A
Insulation resistance measuring device 500 VDC; 10/100 MΩ	1	90-2E
Housing (combined measurement)	1	30-6R
Test sensor	1	94-4S
Calibration	1	90-2A E99
Calibration	1	90-2E E99



Pneumatics







G2.9

Pneumatic supply

All insert panels can be supplied for different pressure ranges if required. Special designs can also be supplied for individual solutions: Special couplings, pressure reducing regulators, filters and controllers as requested.





Technical data

Description		Order no.	
<p>Compressed air supply 3HU / 6HP</p> 		<p>Insert panel with</p> <ul style="list-style-type: none"> 1 Quick coupling NW 5 1/8 1 Quick connectors NW 5 plastic hose 6/4 	<p>48-1K</p>
<p>Compressed air supply 3HU / 36HP</p> 		<p>Insert panel with</p> <ul style="list-style-type: none"> 1 Pressure regulator 0,5...10 bar, 1 Pressure gauge 0...10 bar 2 Quick coupling NW2,5 for input pressure and adjustable pressure 1 Quick connectors 	<p>48-1G</p>
<p>Compressed air supply 3HU / 36HP</p> 		<p>Insert panel with compressed air supply</p> <ul style="list-style-type: none"> 1 reducing valve of high precision to which the external supplied pressure is connected to 1 3/2- valve for directing the pressure to the output couplings or to disconnect the pressure 2 leakfree one- hand quick- acting couplings NW2,5 1 Quick connectors NW 2,5 <p>Pressure range</p> <ul style="list-style-type: none"> 0 ... 4 bar 0 ... 10 bar 	<p>48-1D Z01 48-1D Z02</p>

Pneumatic Accessories

Technical data

Description		Order no.
Connector hose 6/4 mm		single Quick connectors NW5 10 bar 500 mm single Quick connectors NW5 10 bar 1000 mm single Quick connectors NW5 10 bar 2000 mm single Quick connectors NW2,5 10 bar 500 mm single Quick connectors NW2,5 10 bar 1000 mm single Quick connectors NW2,5 10 bar 2000 mm
Manometer connectors		R 1/8" R 1/4" R 3/8" R 1/2"
High pressure hose DN4		Minimesh-Connections 400 bar 630 mm Minimesh-Connections 400 bar 1000 mm
Quick connectors for single-handed rapid-action connectors		NW5 for coupling hose 6/4 mm NW2,5 for coupling hose 6/4 mm
10 bar air supply for bench rack plug-in module s		Coupling type 3 take off points Coupling type 5 take off points

Cable will be laid in the back side of bench rack.

Z = Please specify associated bench rack

G Electronics



System 3HU

Decades & logades







G2.10

Load resistors, decade, logade

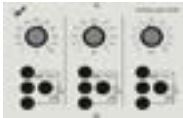
Rapid accessibility of such typical values as resistances, capacities and inductivities is particularly advantageous in the laboratory environment.



Technical data

Description		Order no.
<p>Load resistors 3HU / 36HP</p> 	<p>Eurocassette with 3 adjustable load resistors, each capable of bearing loads of 50W Resistance values: 0...100 Ohm / 50 W 0... 1 kOhm / 50 W 0...10 kOhm / 50 W</p> <p>3 Fine wire fuses 9 Safety lab terminals</p>	42-2N
<p>C decade 3HU / 24HP</p>  <p> Fits into 3HU alu-channel</p>	<p>Insert panel with C decade 100pF..9.9999µF, adjustable in 100pF increments via 5 preselection switches with large numbers in their display windows Tolerance: 100 pF...1000 pF: ± 10 % type ± 13 % max. 100 pF.. 9,9 nF: ± 5 % type ± 8 % max. 10 nF..99,9 nF: ± 3 % type ± 5 % max. 1 µF..9,99 µF: ± 2 % type ± 5 % max. Permissible operating voltage: 50 V DC</p>	42-2G
<p>Inductivity logade 3HU / 18HP</p>  <p> Fits into 3HU alu-channel</p>	<p>Insert panel with inductivity logade 1...4700µH Preselection: 23 values graded acc. to row E6, adjustable by rotary switch Imprecision: 1...33 µH, ± 10 % 47...4700 µH, ± 5 % Operating voltage: maximum 100 V DC Operating current: maximum 63 mA, secured with fine wire fuse 2 Safety lab terminals</p>	42-2R
<p>R decade 3HU / 24HP</p>  <p> Fits into 3HU alu-channel</p>	<p>Insert panel with R decade 1Ohm...999.999kOhm, adjustable in 1Ohm increments via 6 preselection switches with large numbers in their display windows Tolerance: 1 Ohm... 9 Ohm <10 % + 0,9 Ohm 10 Ohm...99 Ohm <2 % + 0,9 Ohm 100 Ohm...999 Ohm <1 % + 0,9 Ohm > 1000 Ohm <1 % Load: maximum 1 W Connection voltage: maximum 250 V AC maximum 50 V DC</p>	42-2F

Interfaces

G2.11

Technical data

Description		Order no.
<p>LPT-Interface 3HU / 6HP</p> 		<p>1 SUB-D 25-pole female with ca. 3 m connection cable and mating connector</p> <p>46-7A</p>
<p>COM-Interface / RS232 3HU / 6HP</p> 		<p>1 SUB-D 25-pole male 1 SUB-D 9-pole male</p> <p>both with ca. 3 m connection cable and mating connector</p> <p>46-7B 46-7C</p>
<p>VGA-Interface 3HU / 6HP</p> 		<p>1 SUB-D HD 15-pole female with ca. 3 m connection cable and mating connector</p> <p>46-7D</p>
<p>DVI-I-Interface 3HU / 6HP</p> 		<p>1 DVI-I female with ca. 3 m connection cable and mating connector</p> <p>46-7E</p>
<p>S-VHS-Interface 3HU / 6HP</p> 		<p>1 PS / 2 Mini-DIN, 4-pole female with ca. 2 m connection cable and mating connector</p> <p>46-7M</p>
<p>USB-Interface 3HU / 6HP</p> 		<p>2 USB, Type A, female with ca. 3 m connection cable and mating connector</p> <p>46-7F</p>
<p>PS/2-Interface 3HU / 6HP</p> 		<p>2 PS / 2 Mini-DIN, 6-pole female with ca. 3 m connection cable and mating connector</p> <p>46-7G</p>
<p>Audio-Interface 3HU / 6HP</p> 		<p>2 Audio, Cinch, red and white, female with ca. 2,5 m connection cable and mating connector</p> <p>46-7H</p>

Technical data

Description			Order no.
<p>Audio-Interface 3HU / 6HP</p> 		<p>1 stereo jack socket 3.5mm, stereo with ca. 3 m connection cable and mating connector</p>	46-7J
<p>FireWire-Interface 3HU / 6HP</p> 		<p>1 IEEE-1394, 6-pole with ca. 3 m connection cable and mating connector</p>	46-7K
<p>RJ-45-Interface 3HU / 6HP</p> 		<p>1 RJ-45-connector socket 8-pole Cat6 pluggable on both sides with ca. 3 m patch cable</p> <p>2 RJ-45-connector socket 8-pole Cat6 pluggable on both sides with ca. 3 m patch cable</p>	46-7L 46-7L Z002
<p>Data socket RJ-45 3HU / 18HP</p> 		<p>Insert panel with 1 double socket RJ45 Cat. 6 shielded non-wired</p>	44-2D
<p>Hollow wall socket 3HU / 18HP</p> 		<p>Insert panel with 1 hollow wall socket for installation of an antenna, mains or telephone socket</p>	40-1B Z004
<p>Antenna socket 3HU / 18HP</p> 		<p>Insert panel with 1 antenna socket for radio, TV, SAT</p>	44-2E
<p>IEEE 488-Interface 3HU / 6HP</p> 		<p>IEEE-488 centronics 24-pin female with approx. 3m connection cable and mating connector</p>	46-7N
<p>Supply strip 3HU / 6HP</p> 		<p>Insert panel with power supply with 2 BNC installation jack sockets 50 Ohm can be pluggable on both sides unwired</p>	46-7P

Technical data

Description			Order no.
<p>ASi-Interface 3HU / 6HP</p>  <p>Fits into 3HU alu-channel</p>		<p>Insert panel interface panel ASi with 4 laboratory safety sockets 4 mm yellow non-wired</p>	46-7Q
<p>PROFI NET-Interface 3HU / 6HP</p>  <p>Fits into 3HU alu-channel</p>		<p>Insert panel PROFI NET interface panel with 2 RJ45 connector, 8-pin, pluggable on both sides with approx. 3 m patch cable</p>	46-7R
<p>PROFI BUS-Interface 3HU / 6HP</p>  <p>Fits into 3HU alu-channel</p>		<p>Insert panel PROFI BUS interface panel with 1 Sub-D adapter 9-pin, male, with mating connector female un-wired</p>	46-7S
<p>HDMI-Interface 3HU / 6HP</p>  <p>Fits into 3HU alu-channel</p>		<p>Insert panel with 1 HDMI 1.3 feed-through with 19-pin HDMI connector on both sides</p>	46-7T
<p>Multiple interface panel 3HU / 24HP</p>		<p>Insert panel with</p> <ul style="list-style-type: none"> 2 USB connectors, type A female 2 PS/2 Mini-DIN 6-pin connectors, female 1 Sub-D connector 9-pin male 1 Sub-D connector 15-pin HD female each with approx. 2 m connection cable and mating connector 2 jack sockets, 3.5 mm stereo with approx. 3m connection cable and mating connector 1 RJ45 connector, 8-pin, pluggable on both sides 	46-7V
<p>Insert panel 3HU / 18HP</p>  <p>Fits into 3HU alu-channel</p>		<p>Insert panel with selective poles for interconnecting test stations</p> <ul style="list-style-type: none"> 9 not wired up safety lab terminals 16 A 2 not wired up BNC-jacks Z = 50 Ohm 	46-1D





Soldering station

G2.12

Technical data

Description		Order no.	
<p>Soldering station 3HU / 36HP</p>  <p>Fits into 3HU alu-channel</p>		<p>Insert panel with temperature-controlled soldering station, temperature in the range 150...400°C continuously adjustable by means of a rotary potentiometer analogue control technology ideal for lead-free soldering, RoHS-compliant</p> <ul style="list-style-type: none"> 1 soldering iron basis tool 810 CDJ 1 soldering tip 0832 CD 1 stand 0A 41 	<p>46-1F</p>
<p>Soldering station 3HU / 36HP</p>  <p>Fits into 3HU alu-channel</p>		<p>Insert panel with temperature-controlled soldering station, model Weller WS 81 Temperature in the range 150...400°C continuously adjustable by means of a rotary potentiometer analogue control electronics with automatic tool recognition up to 80W ideal for lead-free soldering, RoHS-compliant the soldering tip is floating at the time of shipment</p> <ul style="list-style-type: none"> 1 soldering iron WSP 80 1 soldering tip LT B 1 1 safety compartment WPH 80 	<p>46-1G</p>

Technical data

Description		Order no.	
Soldering station 3HU / 18HP		<p>Eurocassette with temperature-controlled 80W soldering station, temperature in the range 150...400°C continuously adjustable and electronically controlled, ideal for lead-free soldering, RoHS-compliant.</p> <ul style="list-style-type: none"> 1 Soldering iron 1 LED for regular visual inspection 1 Stand 1 Illuminated rocker switch 	46-1A
Soldering station 3HU / 18HP		<p>Eurocassette with temperature-controlled, floating 80W soldering station, temperature continuously adjustable up to 450°C, manufactured by Weller, ideal for lead-free soldering, RoHS-compliant.</p> <ul style="list-style-type: none"> 1 Soldering iron 1 LED for regular visual inspection 1 Stand 1 Illuminated rocker switch 	46-1H
Soldering station 3HU / 24HP		<p>Eurocassette with temperature-controlled, antistatic 80W soldering station, temperature continuously adjustable up to 450°C, manufactured by Weller, ideal for lead-free soldering, RoHS-compliant.</p> <ul style="list-style-type: none"> 1 Digital display 1 Antistatic soldering iron 1 Stand 1 Illuminated rocker switch 	46-1K
Soldering and unsoldering station 3HU / 36HP		<p>Eurocassette with electronic soldering and unsoldering station for industrial application and for repair stations, temperature continuously adjustable between 150...400°C, ideal for lead-free soldering, RoHS-compliant.</p> <ul style="list-style-type: none"> 2 Digital temperature displays 1 Installed vacuum/compressed air unit; this results in the station being independent of compressed air supplies 1 Soldering iron 80W 840 CDJ 1 Unsoldering iron 80W 720 ENJ 2 Connection jack socket for soldering/desoldering irons 1 Potential equalisation connector 2 Quick-release couplings for vacuum and compressed air 2 Stands 2 Illuminated rocker switch 	46-1M Z601
Installation kit			46-1N.3ZW-EBS

G Electronics



System 3HU

Housing and accessories

G2.13

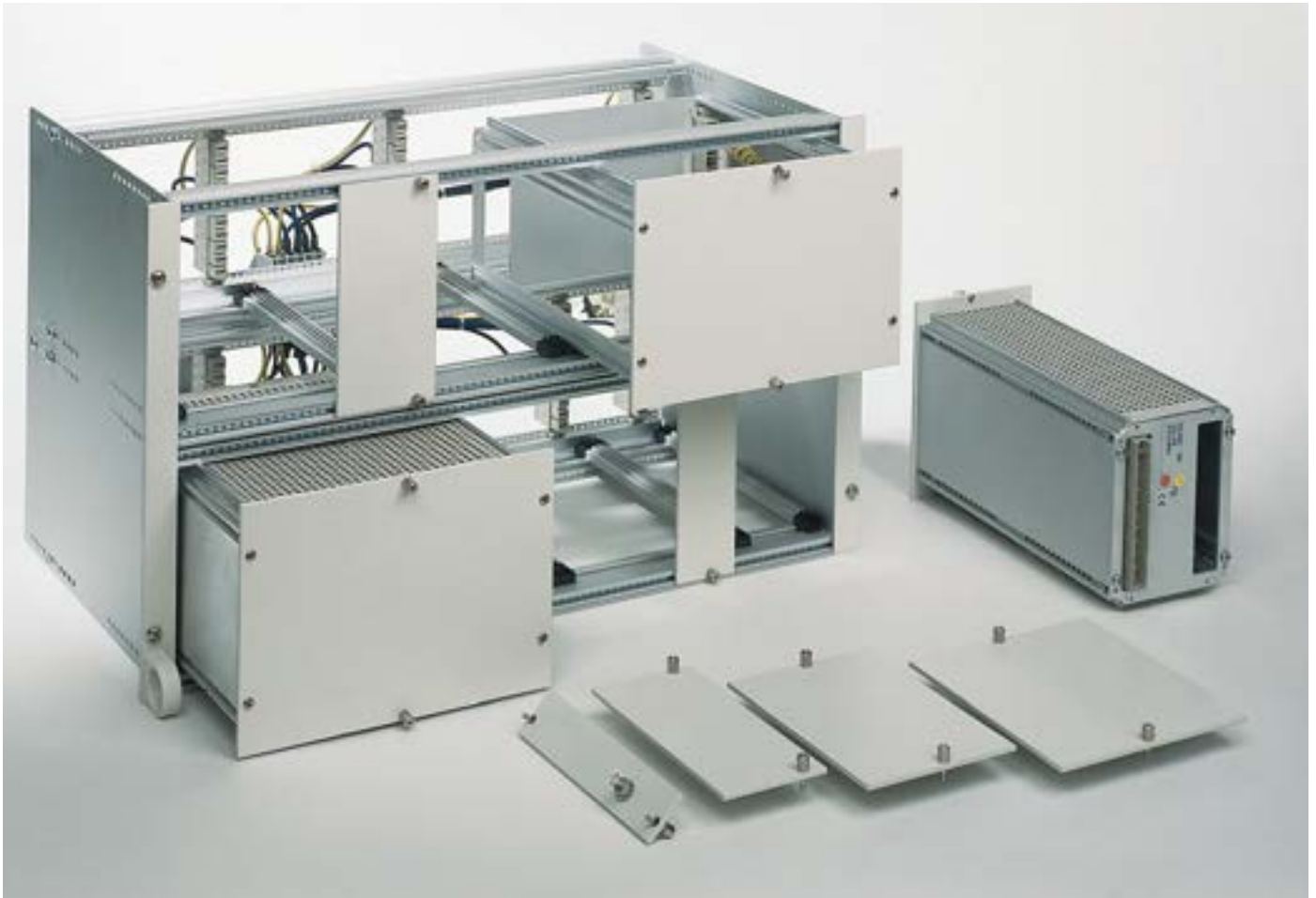

Blank plates:

Blank plates in the system eurocassettes fill remaining space in the desktop rack. They are comprised of 3 mm thick hard aluminium with an epoxy resin powder coating, colour: light grey. Undetachable Philips head screws are mounted above and below for fastening in the subrack or in the housing.

The height of all of the plates is 128.5 mm = 3HU.

Empty eurocassettes, open version:

The eurocassettes are shipped without lateral and upper or lower covers.

The front plates correspond in their design to the blank plates. The depth profiles are comprised of an extruded aluminium strand profile. The rear wall is made of 2 mm aluminium and provided with a punch-out for male multipoint connectors in accordance with DIN 41612. Empty eurocassettes are always shipped with an 11-pin male and female multipoint connector with high-current contacts and a pair of guide rails.

Height: 128.5 mm = 3HU

Depth: 196 mm

Empty eurocassettes, closed version:

Version as above, but with closed sides, upper and lower covering. The upper or lower cover is perforated.

Height: 128.5 mm = 3HU

Depth: 196 mm

Blank plate, empty eurocassette

3HU



Passend für 3HE
Alukanal

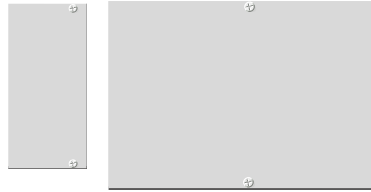

Blank plates are comprised of 3 mm thick hard aluminium, powder-coated in light grey on both sides (similar to RAL 7035). Special undetachable Philips screws are mounted for fastening purposes which can also be used for dismantling purposes. An earthing bolt size M5 is welded to the rear side of the blank plate. Uniform front plate height 3HU = 128.5mm.

3HU / 4HP	20,3 mm wide	40-1H
3HU / 6HP	30,4 mm wide	40-1G
3HU / 8HP	40,3 mm wide	40-1J
3HU / 12HP	60,9 mm wide	40-1A
3HU / 18HP	91,4 mm wide	40-1B
3HU / 24HP	121,9 mm wide	40-1C
3HU / 36HP	182,9 mm wide	40-1D
3HU / 42HP	213,3 mm wide	40-1E
3HU / 48HP	243,8 mm wide	40-1F
3HU / 60HP	304,8 mm wide	40-1K
3HU / 96HP	487,6 mm wide	40-1L



Empty eurocassettes, open version

In addition to the front plate, empty eurocassettes contain an additional 4 depth profiles comprised of an extruded aluminium stand profile, a 2 mm thick aluminium rear wall with punch-out for one male multipoint connector in accordance with DIN 41612. Empty eurocassettes are shipped with 11-pin male and female multipoint connector and a pair of guide rails. Eurocassette depth is a uniform 196 mm.

3HU / 12HP	60,9 mm wide	40-2A
3HU / 18HP	91,4 mm wide	40-2B
3HU / 24HP	121,9 mm wide	40-2C
3HU / 36HP	182,9 mm wide	40-2D
3HU / 42HP	213,3 mm wide	40-2E
3HU / 48HP	243,8 mm wide	40-2F



Empty eurocassettes, closed version

Closed empty eurocassettes are equipped with a closed aluminium side wall profile. The upper and lower covering is provided by a perforated aluminium sheet which is supported in removable fashion in the side wall profile.

3HU / 12HP	60,9 mm wide	40-3A
3HU / 18HP	91,4 mm wide	40-3B
3HU / 24HP	121,9 mm wide	40-3C
2HU / 36HP	182,9 mm wide	40-3D
3HU / 42HP	213,3 mm wide	40-3E
3HU / 48HP	243,8 mm wide	40-3F

Housing

Technical data

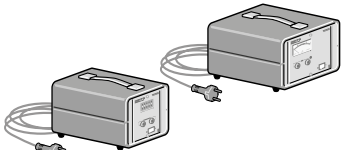
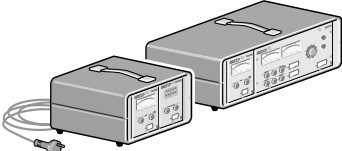
Description		Order no.
Support housing	 <p>Aluminium housing 3HU 1 connection cable, 1-phase, with Schuko plug Colour: light grey</p> <p>with Space für 24HP W = 170 mm, D = 285 mm, H = 150 mm</p> <p>with space for 36HP W = 230 mm, D = 285 mm, H = 150 mm</p>	<p>30-6L</p> <p>30-6M</p>
Support housing	 <p>Aluminium housing 3HU 1 connection cable, 1-phase, with Schuko plug Colour: light grey</p> <p>with space for 42HP W = 260 mm, D = 285 mm, H = 150 mm</p> <p>like 30-6P but with 1x RJ45, 1x USB Type B Interface in the back</p> <p>with space for 84HP W = 475 mm, D = 285 mm, H = 150 mm</p> <p>with space for 84HP, with wiring for PE and IS testing equipment W = 475 mm, D = 285 mm, H = 150 mm</p>	<p>30-6P</p> <p>30-6P Z002</p> <p>30-6N</p> <p>30-6R</p>





The aluminium shell housing enables the mobile utilisation of Elabo 3HU eurocassettes. Aluminium traverse profiles are mounted inside with M 2.5 threads at the front and the rear in 5.08 mm separation grids in accordance with DIN 41494. A female multipoint connector with 11 high-current contacts serves as the insert mating connector.

The 3HU housing can be loaded in the specified horizontal pitches (1HP = 5.08 mm) with eurocassettes. The version is completely wired with 4 housing feet, carrying grip and 2.5m of connection cable with Schuko plug

Accessories for cassettes and subracks

Technical data

Description		Order no.	
Spacer bolt		Spacer bolt for eurocassettes with a depth of 160mm. The bolt fits the female multipoint connector in the Subrack.	39-1A
Guide rails		Guide rails (2 pcs.) for 160 mm deep eurocassettes.	39-1C
Guide rails		Aluminium guide rails (2 pcs.) with plastic head; for eurocassettes with a depth of 196mm. The rails can be utilised in 5.08mm section widths in the Subrack.	39-1B
Female multipoint connector		Female multipoint connector with 11 high current contacts	39-1D
Male multipoint connector		Male multipoint connector with leading earth contact, for female multipoint connector 39-1D	39-1E
Female multipoint connector		Female multipoint connector with 7 high current contacts and 24 wire wrap posts	39-1F
Male multipoint connector		Male multipoint connector for female multipoint connector 39-1F, equipped with angled soldering contacts	39-1G
Female multipoint connector		Female multipoint connector with 64 wire wrap posts, rows a and c loaded (DIN 41612, model C)	39-1H
Male multipoint connector		Male multipoint connector for female multipoint connector 39-1H (model C), equipped with 64 angled soldering contacts	39-1J
Female multipoint connector		Female multipoint connector with 96 wire wrap posts, rows a, b and c loaded (DIN 41612, model C)	39-1K
Male multipoint connector		Male multipoint connector for female multipoint connector 39-1K (model C), equipped with 96 angled soldering contacts	39-1L

Ordering accessories for rack mounts is only necessary if spare parts are required or if the rack is to be extended. All Elabo insert panels, slide-in units and cassettes are always supplied fully equipped and ready for use. Includes cable set, guide rails and mains connectors (male/female multipoint connectors).

G Electronics



Table of contents

G3.1 Safety- and protection modules	311
G3.2 AC power supply, fixed	313
G3.3 AC power supply, adjustable	317
G3.4 DC-power supply, fixed	329
G3.5 DC-power supply, adjustable	331
G3.6 Measuring- and signal devices	345
G3.7 High voltage tester	353
G3.8 Combination test devices	357
G3.9 Pneumatics	363
G3.10 Decades & logades	369
G3.11 Interfaces	373
G3.12 Soldering station	375
G3.13 Housing und accessories	377

6HU

System 6HU

G3

System Overview 6HU

The racks and housing of the System 6HU can be loaded with the following Insert panels, inserts, Subracks (for 3HU eurocassettes) and blank plates.

6HU

Technical information

The System 6HU is comprised of Insert panels, inserts and 2-row Subracks for holding System 3HU eurocassettes.

Front panels:

All front plates are comprised of 3 mm hard aluminium, powder-coated in light grey on both sides (similar to RAL 7035). The lettering is applied with indelible screen printing.

Inserts:

All inserts are additionally equipped with perforated steel side panels, an adjustable chassis plate and a mounting bracket. The rear side of the insert is equipped with a 6-pin Harting plug with a leading earth contact.

Subracks:

For supporting eurocassettes from the 3HU eurocassette system.

Laterally closed aluminium support sheets, which support the front and rear traverse profiles.

Front and rear profiles equipped in 5.08mm grids with M2.5 threads. Interior profiles are equipped with an integrated fastening rail for female multipoint connectors in accordance with DIN 41612.

6HU devices can be used in superstructures of the product lines InFom and EcoTec, as well as in Primus One.

Distinguishing features:

Primus One



Installation widths

18HP	= Installation width 91,4 mm
21HP	= Installation width 106,6 mm
24HP	= Installation width 121,9 mm
42HP	= Installation width 213,3 mm
88HP	= Installation width 447,0 mm
96HP	= Installation width 487,6 mm

Insert panel depth= 260,0 mm

Use of devices with system Primus One 6 HU please add the letter "K" to article number

Example:

32-1J.K for Primus One

6HU

Safety- and protection modules

G3.1

Technical data

Description		Order no.	
Mains supply panel 1-phase 6HU / 1WU 6HU / 21HP		Insert panel Mains supply panel 1 Earth-leakage circuit breaker type A 2-pole 16 A / 10 mA 1 Circuit breaker 16 A C 1 Contactor 1 Key switch button 1 Off button 1 External conductor indicator lamp	32-0D
Mains supply panel 1-phase 6HU / 1WU 6HU / 21HP		Insert panel Mains supply panel 1 Earth-leakage circuit breaker Type A 2-pole 25 A / 30 mA 1 Motor circuit breaker 10..16 A with thermal and magnetic actuation 1 Undervoltage actuator for protection against autonomous voltage return 1 Key-operated switch 1 External conductor indicator lamp like 32-0B, but with 1 Earth-leakage circuit breaker type B 4-pole 25 A / 30 mA	32-0B 32-0B Z024
Mains supply panel 3-phase 6HU / 1WU 6HU / 21HP		Insert panel Mains supply panel 1 Earth-leakage circuit breaker 4-pole 25 A / 30 mA 1 Motor circuit breaker 10...16 A with 1 Undervoltage actuator for protection against autonomous voltage return 1 Key-operated switch 3 External conductor indicator lamp Type A, for alternating residual currents and pulsating direct residual currents Type B, sensitive to all current types, also for non-pulsating direct residual currents	32-0A 32-0F
Mains supply panel 3-phase 6HU / 2WU 6HU / 42HP		Insert panel Mains supply panel 1 Earth-leakage circuit breaker type A 4-pole 25 A / 30 mA 1 Motor circuit breaker 10...16 A 1 Undervoltage actuator 4 Schuko sockets for drawing 230 V / 16 A 5 Safety lab terminals for drawing 400 V / 16 A, designated L1, L2, L3, N, PE 1 non-wired emergency off switch with snap-on contact and yellow signal ring 1 Key-operated mushroom switch 3 External conductor indicator lamp like 32-0C, but 1 Earth-leakage circuit breaker type B 4-pole 25 A / 30 mA	32-0C 32-0C Z001

6HU

AC power supply, fixed





G3.2

AC- power supply 1-phase, fixed

Elabo plates and inserts with floating alternating current voltage can be used in many ways – e.g. for measurements of inductivities and capacities, in production test rooms or as floating voltage supply systems for training, servicing and development.

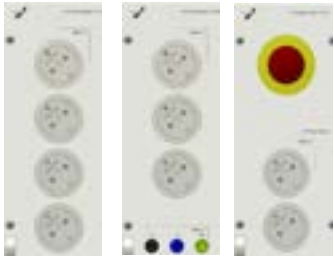
6HU

Technical data



Description			Order no.
AC power supply 1-phase 6HU / 1WU 6HU / 21HP		Insert panel for supplying with alternating current voltage 230 V AC / 16 A 4 Schuko sockets 3 Schuko sockets 3 Safety lab terminals L1, N, PE 2 Schuko sockets, 1 Emergency off switch, non-wired	32-1J 32-1M 32-1P
AC power supply 1-phase 6HU / 1WU 6HU / 21HP		Insert panel for supplying with floating extra-low alternating current voltage 2, 4, 6, 8, 10, 12 V AC / 10 A 4 Safety lab terminals for drawing extra-low alternating current voltages 3 Thermic-magnetic circuit breakers 1 Illuminated rocker switch	32-1E
AC power supply 1-phase 6HU / 1WU 6HU / 21HP		Insert panel for supplying with floating extra-low alternating current voltage 6, 12, 18, 24, 36, 42 V AC / 3 A 4 Safety lab terminals for drawing extra-low alternating current voltages 3 Thermic-magnetic circuit breakers 1 Illuminated rocker switch	32-1F
AC power supply 1-phase with line filter 6HU / 1WU 6HU / 21HP		Insert panel for supplying with filtered alternating current voltage 1 Schuko socket for drawing mains voltage 230 V / 16 A. 1 Schuko socket for drawing alternating current voltage through line filter with high attenuation 230 V / 16 A (line filters with special technical data upon request) 1 Fine wire fuse 1 Illuminated rocker switch	32-1R
AC power supply 1-phase 6HU / 1WU 6HU / 21HP		Insert panel for supplying with alternating current voltage 230 V AC / 100 VA 1 Shock-proof socket for drawing 230 V / 100 VA floating 1 Isolating transformer 1 Schuko socket for drawing alternating current voltage 1 Thermic-magnetic circuit breakers 1 Illuminated rocker switch like 32-1S, but trafo 230 VA	32-1S 32-1S Z301

AC- power supply 1-phase and 3-phase, fixed

Elabo plates and inserts with floating alternating current voltage can be used in many ways – e.g. for measurements of inductivities and capacities, in production test rooms or as floating voltage supply systems for training, servicing and development.



Technical data

Description			Order no.
<p>AC power supply 1-phase 6HU / 2WU 6HU / 42HP</p>		<p>Insert panel for supplying with alternating current voltage 230 V AC</p> <ul style="list-style-type: none"> 5 Schuko sockets 3 Safety lab terminals for drawing mains voltage 230 V / 16 A. 1 Shock-proof socket for drawing 230 V / 3 A floating 1 Thermic-magnetic circuit breakers 1 Illuminated rocker switch 	<p>33-0D</p>
<p>AC power supply 1- and 3-phase 6HU / 2WU 6HU / 42HP</p>		<p>Insert panel for supplying with 3-phase alternating current and alternating current voltage</p> <ul style="list-style-type: none"> 1 CEE-Socket 5 Safety lab terminals for drawing alternating current 3 Schuko sockets for drawing alternating current voltage 1 Shock-proof socket for drawing 230 V / 1A, floating 1 Isolating transformer 230 VA 1 Thermic-magnetic circuit breakers 1 A 1 Illuminated rocker switch <p>like Type 33-0A, but with Technical data:</p> <ul style="list-style-type: none"> 1 socket without earth contact for drawing 230 V / 3A, floating 1 Isolating transformer 690 VA 1 Thermic-magnetic circuit breakers 3 A 1 Illuminated rocker switch 	<p>33-0A</p> <p>33-0B</p>
<p>AC power supply 1- and 3-phase 6HU / 2WU 6HU / 42HP</p>		<p>Insert panel for supplying with non-floating 3-phase alternating current</p> <p>3 / N / PE 400 V AC / 6 A / 50 Hz</p> <ul style="list-style-type: none"> 1 Voltmeter 0...400 V, can be switched to outer conductor / outer conductor or outer conductor / neutral conductor via changeover switch 1 Ammeter 0...6A, can be switched on via changeover switch in any phase 1 CEE-Socket 5 Safety lab terminals for drawing 3-phase alternating current 1 Schuko Socket 3 Thermic-magnetic circuit breakers 3 External conductor indicator lamp 1 Off switch 	<p>36-0F</p>

AC- Power supply 1-phase and 3-phase, fixed

Elabo floating AC voltage slide-in units and insert panels are suitable for a wide range of applications. For example, measuring inductances and capacities, in manufacturing test bays or as floating power supplies in education, service and development.

6HU

Technical data

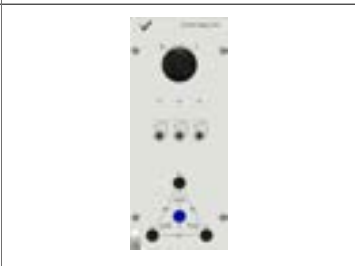
Description			Order no.
AC power supply 1- and 3-phase 6HU / 4WU 6HU / 88HP		Insert panel for supplying with non-floating 3-phase alternating current 230 / 400 V 16 A delta or wye with analogue displays <ul style="list-style-type: none"> 1 Rotary switch I/O 1 Rotary switch 0 / delta / wye 3 Incandescent bulbs 1 Rotary switch 6-stage 1 Voltmeter analog 0...400 V, Moving armature Class 1,5 3 ammeter analogue 0...15 A with 45 A overload scale, moving armature Class 1.5 1 CEE-Socket 5p380 V16 AB 5 Safety lab terminals L1 / U1, L2 / V1, L3 / W1, N, PE 3 Safety lab terminals U2, V2, W2 2 Schuko sockets 3 Safety lab terminals 	36-0E
AC power supply 1- and 3-phase 6HU / 1WU 6HU / 21HP		Insert panel for supplying with floating 3-phase alternating current 3 ~ 23 / 40 V / 3 A <ul style="list-style-type: none"> 4 laboratory safety sockets for drawing alternating current 3 Thermic-magnetic circuit breakers 3 External conductor indicator lamp 1 Rotary switch 1 current transformer with fine wire fuses 	32-1G
AC power supply 1- and 3-phase 6HU / 1WU 6HU / 21HP		Insert panel zur Power supply with non floating alternating current 3 / N / PE ~ 50 Hz 230 / 400V 16 A <ul style="list-style-type: none"> 5 Safety lab terminals for drawing alternating current 3 External conductor indicator lamp 1 Off switch 	32-1H
AC power supply 1- and 3-phase 6HU / 1WU 6HU / 21HP		Insert panel for Power supply with alternating current <ul style="list-style-type: none"> 1 CEE-Socket 16 A 5 Safety lab terminals L1, L2, L3, N, PE for drawing alternating current 1 Schuko socket for drawing alternating current voltage 	32-1L

6HU

AC power supply, adjustable

G3.3

Technical data

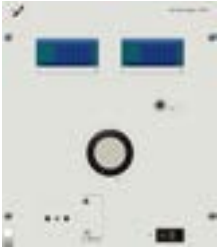
Description		Order no.
AC power supply 1-phase 6HU / 2WU 6HU / 42HP		Plug-in module adjustable, non-floating alternating current voltage 0...260 V AC / 12,5A 1 analogue Voltmeter 0...300 V 1 analogue Ammeter 0... 15 A Load: 12.5A, transient 15A across the entire setting range 1 Schuko socket for drawing 0...260 V / 0...12.5A non-floating 1 PE laboratory safety socket 2 Thermic-magnetic circuit breakers 1 Illuminated rocker switch 0...260 V / 3 A not floating with analogue Voltages- und Ammeter 1 Schuko Socket, 1 Laboratory safety socket 0...260 V / 5 A not floating with analogue voltmeter and ammeter 1 Schuko Socket, 1 Laboratory safety socket
AC power supply 1-phase 6HU / 2WU 6HU / 42HP		Plug-in module adjustable, floating alternating current voltage 0...260 V AC / 3 A 1 Digitalr Voltmeter 0...300 V 1 Digitalr Ammeter 0... 4 A Load: 3 A, transient 4 A across the entire setting range 1 Shock-proof socket 1 Thermic-magnetic circuit breaker 1 Illuminated rocker switch 0...260 V / 5 A floating with analogue voltmeter and ammeter socket without earth contact
AC power supply 1-phase 6HU / 2WU 6HU / 42HP		Plug-in module adjustable, floating alternating current voltage 0...260 V AC / 3 A 1 analogue Voltmeter 0...300 V 1 analogue Ammeter 0... 4 A Load: 3 A, transient 4 A across the entire setting range 1 Shock-proof socket 1 Thermic-magnetic circuit breaker 1 Illuminated rocker switch 0...260 V / 800 W floating with analogue voltmeter and wattmeter 1 Shock-proof socket 0...260 V / 5 A floating with analogue voltmeter and ammeter 1 Shock-proof socket 0...260 V / 1500 W floating with analogue voltmeter and wattmeter 1 Shock-proof socket 0...260 V / 12 A floating with Rotary switch I/O with analogue voltmeter and ammeter 1 Shock-proof socket

AC/DC-power supply

6HU

These inserts provide alternating current voltage which can be continuously adjusted, starting from 0, and can be switched over to direct current. Moving armature instruments with effective value displays are installed for current and voltage measurement. The voltage adjustment is accomplished by means of a variable transformer. The pulsating direct current exhibits a ripple of 48 %. All devices are equipped with an AC/DC selection switch and can also be obtained with digital displays upon request.

Technical data

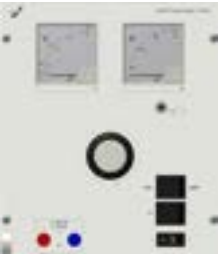
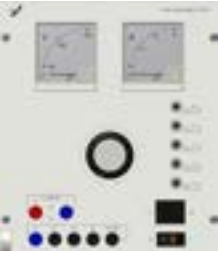
Description			Order no.
<p>AC / DC-power supply 6HU / 2WU 6HU / 42HP</p>		<p>Plug-in for supplying with floating alternating current voltage or direct current AC: 0...60 V / 8 A, can be switched over to DC: 0...60 V / 8 A Effective ripple of the direct current approx ca. 48 % 1 analogue Voltmeter 0...60 V 1 analogue Ammeter 0...10 A 2 Safety lab terminals 1 Rotary knob for adjusting the voltage 1 Changeover switch from alternating current voltage to direct current 1 Thermic-magnetic circuit breakers 1 Illuminated rocker switch</p> <p>Alternating current voltage 0...260 V / 3 A DC voltage 0...260 V / 3 A analogue Voltmeter analogue Ammeter 2 Safety lab terminals</p> <p>Alternating current voltage 0...260 V / 5 A DC voltage 0...260 V / 5 A analogue Voltmeter analogue Ammeter 2 Safety lab terminals</p>	<p>35-0D</p> <p>35-0E</p> <p>35-0F</p>
<p>AC / DC-power supply 6HU / 2WU 6HU / 42HP</p>		<p>Plug-in for supplying with floating alternating current voltage or direct current AC / DC 0... 260 V / 3 A, can be switched over to 0...50 V / 3 A Effective ripple of the direct current approx. 48% 1 analogue Voltmeter 1. Range 0...300 V 2. Range 0...50 V 1 analogue Ammeter 0...4 A 2 Safety lab terminals 1 Rotary knob for adjusting the voltage 1 Changeover switch from alternating current voltage to direct current 1 changeover switch 50 / 260 V 1 Thermic-magnetic circuit breakers 1 Illuminated rocker switch</p>	<p>35-0G</p>
<p>AC / DC-power supply 6HU / 2WU 6HU / 42HP</p>		<p>Plug-in for supplying with floating alternating current voltage or direct current, as with type 35-0E, but with additional extra-low alternating current voltages 2, 4, 6, 8, 10 and 12 V / 10 A. 4 thermal circuit breakers 1 thermal magnetic circuit breaker 1 Changeover switch from alternating current voltage to direct current 1 Illuminated rocker switch</p> <p>floating extra-low alternating current voltage 6, 12, 18, 24, 36, 42 V / 3 A DC voltage 0...260 V / 3 A analogue Voltmeter analogue Ammeter 2 Safety lab terminals</p>	<p>35-0H</p> <p>35-0J</p>

Technical data

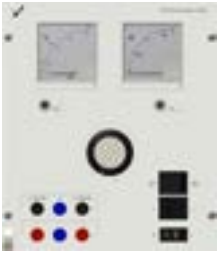
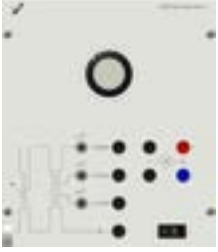
Description		Order no.	
<p>AC / DC-power supply 6HU / 2WU 6HU / 42HP</p>		<p>Plug-in for supplying with floating alternating current voltage or direct current and additional protective function (forced replugging of the load). AC/DC 0... 260 V / 3A, can be switched over to. 0...50 V / 10 A, 1 analogue Voltmeter 1. Range 0...300 V 2. Range 0...50 V 1 analogue Ammeter 1. Range 0...4 A 2. Range 0...10 A Effective ripple of the direct current: approx. 48% 6 Safety lab terminals 1 Rotary knob for adjusting the voltage 1 changeover switch from alternating current voltage to direct current 1 changeover switch 50 V / 260 V 2 Thermic-magnetic circuit breakers 1 Illuminated rocker switch</p> <p>Additional safety is ensured with the 35-0K device in that the load must be unplugged and then replugged at the laboratory safety sockets when switching from alternating current voltage to direct current or from extra-low voltage to low voltage.</p>	<p>35-0K</p>
<p>AC / DC-power supply 6HU / 2WU 6HU / 42HP</p>		<p>Plug-in for supplying with floating alternating current voltage in the ranges: 0...260 V / 3 A 0 ... 42 V / 6 A 0 ... 12 V / 15 A 1 freely switchable rectifier (B2- 300 V / 16 A) for rectifying the alternating current voltages Ripple of the rectified voltages: approx. 48% 1 Rotary knob for adjusting the voltage 8 Safety lab terminals 3 Thermic-magnetic circuit breakers 1 Illuminated rocker switch</p>	<p>35-0L</p>

AC power supply 3-phase adjustable



Elabo eurocassettes with direct current and alternating current voltage for supplying devices in the laboratory and in the test room. Voltage setting by means of a ring core variable transformer with rotary knob, analogue moving armature instruments installed with effective value display.

6HU

Technical data

Description			Order no.
AC power supply 1- and 3-phase 6HU / 2WU 6HU / 42HP		Plug-in module adjustable, non-floating 3-phase alternating current 3 / N / PE 0...400 V AC / 2A, transient to 2.5A 1 V can be switched to outer conductor / outer conductor or outer conductor / neutral conductor via changeover switch 1 Ammeter 0...2,5 A, can be switched to every outer conductor via changeover switch 5 Safety lab terminals L1, L2, L3, N, PE 3 Thermic-magnetic circuit breakers 3 External conductor indicator lamp 1 Off switch	36-0D
AC power supply 1- and 3-phase 6HU / 4WU 6HU / 88HP		Plug-in module adjustable, not floating alternating current 3 / N / PE 0...400 V AC / 5 A, transient 6A with analogue displays and mains voltage 1/N/PE ~ 50 Hz 230 V 16 A 1 Rotary switch I/O 3 Incandescent bulbs 1 economy variable transformer for 3-phase current 1 Rotary switch Mains/trafo 3 Thermic-magnetic circuit breakers TMT5A 3 Ammeter analog 0...6 A, Moving armature Class 1,5 1 Rotary switch 6-stufig 1 Voltmeter analog 0...400 V, Moving armature Class 1,5 1 CEE-Socket 5-pole 400 V / 16 A 5 Safety lab terminals 1 Schuko Socket 0...230 V / 5 A or 1 / N / PE ~ 50 Hz / 230 V / 5 A 1 Schuko socket 230 V / 16 A 3 Safety lab terminals	36-0A
		like 36-0A but with output current up to 8 A, transient up to 10 A 3 ammeters 0...10 A	36-0B
		similar to type 36-0A, 3 / N / PE 0...290/500 V AC / 4A 1 voltmeter 0...500 V 3 ammeters 0...6A 3 circuit breakers 1-pin K 4A	36-0C

Technical data

Description		Order no.
<p>AC power supply 6HU / 4WU 6HU / 88HP</p>	 <p>Plug-in module with non-floating 3-phase alternating current 0...230 / 400 V / 5A (transient 6A) with electromotive control for variable voltage adjustment</p> <ul style="list-style-type: none"> 1 CEE Socket 16 A 5 Safety lab terminals 1 Schuko Socket 3 Safety lab terminals 3 phase controll lamps 1 10-turn potentiometer for manual adjustment of the output voltage 1 rocker pushbutton switch for switching off the output voltage <p>The following measurement values can be selected for display by means of a multi-function display feature:</p> <p>Neutral conductor current, active power measurement (W), idle power measurement (VAr kap, VAr ind), apparent power measurement (VA), power factor measurement (cos phi), frequency.</p>	<p>36-5A</p>
<p>NET networkable</p>		<p>like 36-5A with 2 Ethernet interfaces for remote control</p> <p>36-5A Z102</p>
<p>AC-Measuring unit 6HU / 2WU 6HU / 42HP</p> <p>NET networkable</p>	 <p>Plug-in module</p> <p>Multifunctional display brand Janitza for measuring storing an monitoring of electrical values as:</p> <ul style="list-style-type: none"> - voltage - current - frequency - power factor - effective power - apparant power - reactive power per phase and in total - real energy - reactive energy - Cos Phi <p>Measuring accuracy (related to nominal value)</p> <p>current, voltage $\pm 0,2 \%$, power $\pm 0,5 \%$ power factor $\pm 0,5 \%$, energy $\pm 0,5 \%$ frequency $\pm 0,02$ Hz (absolut)</p> <p>Design: connection of power supply and consumer in front via 2x5 safety lab terminals L1, L2, L3, N, PE</p> <p>Internal: AC 3~ 0...230/400 V 16 A</p> <p>External: Rated voltage L- L 480 V, L- N 277 V Current: 16 A</p> <p>Including Ethernet-Interface</p> <p>Other voltages and current ranges available optionally. Elabo cassettes can supply direct and alternating voltage to laboratory and test bay equipment. The voltage is set on a variable toroidal transformer via a rotary knob with 100% scale. Analogue moving-iron instruments with root-mean-square indication are fitted.</p>	<p>36-5B</p>

AC / DC- power supply 3-phase

Elabo cassettes can supply direct and alternating voltage to laboratory and test bay equipment. The voltage is set on a variable toroidal transformer via a rotary knob with 100% scale. Analogue moving-iron instruments with root-mean-square indication are fitted.

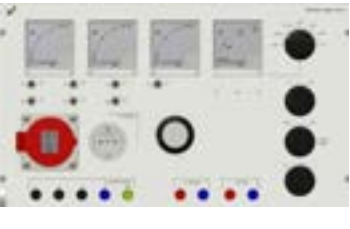

Technical data

Description		Order no.
<p>AC / DC-power supply 6HU / 4WU 6HU / 88HP</p>		<p>36-1C</p>
		<p>36-1A</p>
<p>AC / DC-power supply 6HU / 4WU 6HU / 88HP</p>		<p>36-1D</p>
		<p>36-1E</p>

Test panels

The test panels 36-2A and 36-3A are suitable for general use in test areas.

6HU

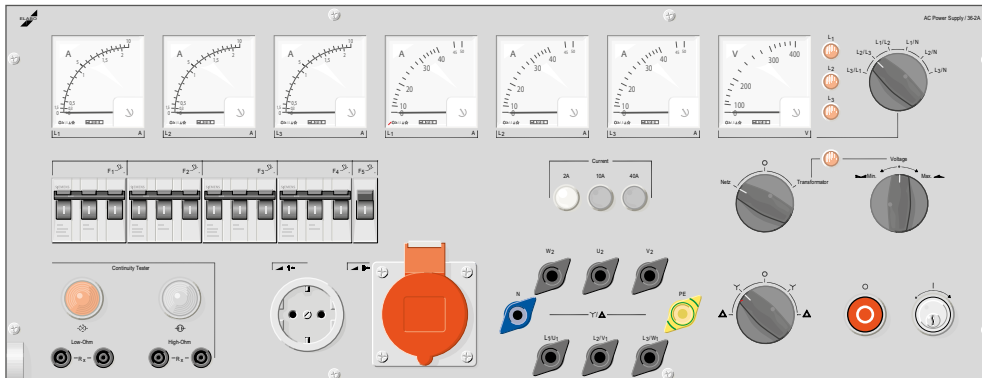

Highlights

Test panel with three current ranges 6HU / 6WU

Operating modes

- "Mains" Mains voltage is connected, via the measurement instruments, to the lab terminals resp. socket outlets.
- "Trafo" In this switch position the output terminals and sockets are supplied with a continuously adjustable voltage from a variable- ratio transformer (not part of the delivery, it has to be ordered separately).
- Setting 1 selector switch "Mains"- 0- "Trafo"

Current measurement

- Selection 3 ranges 2 A / 10 A / 40 A, selectable by using three mutually cancelling push- buttons.
- Display 3 moving coil ammeters protected by two 3- pole automatic circuit breakers for each range. Current measurement ranges are combinedly switched over. As range- changing does not interrupt the supply, no new inrush surges occur. This makes exact measurement of the current possible, e.g. after starting up an electric motor.

Voltage measurement

- Selection 1 button: Min and Max are used to set the voltage when a motorized variable- ratio transformer is in use (to be ordered separately) "Min" button decreases, "Max" button increases the voltage
- Display 1 moving-coil voltmeter 0...400 V with measuring rectifier and linear scale can be switched to phase / phase or phase / neutral.
- Continuity test High- resistance 230 V AC, displayed by 230 V glow lamp Low-resistance 24 V AC, displayed by 24 V incandescent lamp.
- Mains supply 1 marked terminal block for 3- phase AC 3/ N/ PE 400 V AC / 40 A / 50 Hz
- Trapping off 1 CEE- socket 16 A 5-pole
6 laboratory terminals 63 A, for combinations of push- lock terminal connection, in terminal board arrangement
W2 U2 V2 L1/ U1 L2 / V1 L3 / W1 2 laboratory terminals, 63A N/ PE with push- lock terminal connection
- Main switch 1 key- switch- On
1 off push button
1 x 5- pole contactor
3 3- phase indicator lamps
- Protection 1 fuse (control circuit)
1 3- pole circuit breaker 16 A for the reserve
- Motor start 1 reversing star- delta switch:
- Optional features Module rectifier 25 A model 36-2B,
Module rectifier 40 A model 36-2C
Module pole- changing switch model 36-2D.
- Remark The 3- phase variable- ratio transformer is not included in the delivery.
It has to be ordered separately (model 36-2G or 36-2H).

Order-No. 36-2A

Test panels

This test panel allows 4 current ranges to be selected. For clear reading there are 4 large moving coil ammeters integrated. Used together with a 3- phase variable- ratio transformer the operator can perform a multitude of applications fault diagnosis of single and 3 phase equipment of all kind.

6HU



Highlights

Test panel with four current ranges 6HU / 6WU

Operating modes

- "Mains" Mains voltage is connected, via the measurement instruments, to the lab terminals, resp. socket outlets.
- "Transformer" In this position the output terminals and socket outlets are supplied with a continuously adjustable voltage from a variable- ratio transformer (not part of the delivery, it has to be ordered separately).
- Setting 1 selector switch "Mains" – 0 – "Transformer"

Current measurement

- Selection 4 ranges 1.5 A / 4 A / 15 A / 40 A, selectable by using four mutually cancelling push- buttons.
- Display 3 moving-coil ammeters protected by 3 pole automatic circuit breakers for each range. Current measurement ranges are combinedly switched over. As range- changing does not interrupt the supply, no new inrush surges occur. This makes exact measurement of the current possible, e.g. after starting up an electric motor.

Voltage measurement

- Selection button: Min and Max are used to set the voltage when a motorized variable- ratio transformer is in use (to be ordered separately).
"Min" button decreases,
"Max" button increases the voltage
- Display 1 moving-coil voltmeter 0...400 V, with measurement rectifier and linear scale; can be switched to phase / phase or phase / neutral

Continuity testing: High-resistance 230 V AC, displayed by 230 V glow lamp low-resistance 24 V AC, displayed by 24 V incandescent lamp.

Mains supply: 1 marked in-line terminal block for three-phase 3 / N / PE ~ 50 Hz 400 V / 40 A

Outputs: 1 CEE socket 16 A 5-pole 6 laboratory terminals 63 A, for combinations of push- lock terminal connection, in terminal board arrangement.

W2 U2 V2
L1 / U1 L2 / V1 L3 / W1

2 laboratory terminals, 63A N/ PE with pushlock terminal connection

Main switch: 1 keyswitch ON
1 off push button
1 x 3 pole contactor
3- phase indicator lamp

Protection: 1 fuse (control circuit)
1 3- pole circuit breaker 16 A for reserve

Motor start: 1 reversing star- delta switch

Optional features: Module rectifier 25A model 36-2B,
Module rectifier 25A model 36-2B,
Module pole-changing switch model 36-2D

Remark: The 3- phase variable- ratio transformer is not included in the delivery.
It has to be ordered separately (model 36-2G or 36-2H)

Technical data



Description		Order no.
Variable ratio 3- phase transformer 6HU	Variable ratio 3- phase transformer with motor drive for test panels 36-2A and 36-3A. Power output: 17,3 kVA Input: 3 / N / PE ~ 50 Hz 400 V Output: 3 / N / PE 0...400 V / 25 A Drive: Capacitor motor 230 V / 50 Hz 1 powder coated sheet steel housing W = 445 mm, D = 445 mm, H = 980 mm, Degree of protection IP 20	36-2G Zxx
Variable ratio 3- phase transformer 6HU	Variable ratio 3- phase transformer with motor drive for test panels 36-2A and 36-3A. Power output: 27,6 kVA Input: 3 / N / PE 230 / 400 V AC Output: 3 / N / PE 0...230 / 400 V / 40 A Drive: Capacitor motor 230 V / 50 Hz 1 powder coated sheet steel housing W = 445 mm, D = 445 mm, H = 980 mm, protected to IP 20	36-2H Zxx
Inrush current limiter 6HU	Inrush current limiter for variable- ratio 3- phase transformer model 36-2G (25 A). When the transformer is switched on, a very high initial current flows which may trip the supply circuit breakers. By fitting the current limiting device, this inrush current is limited to a tolerable level. The device is installed in the transformer housing and wired into the primary circuit. W = 150 mm, D = 100 mm, H = 120 mm	36-2E
Inrush current limiter 6HU	Inrush current limiter for variable- ratio 3-phase transformer model 36-2H (40 A) W = 150 mm, D = 100 mm, H = 120 mm	36-2F

Application: Limitation of starting currents, review of stators and rotors when unmounted, error analysis e.g. for interturn. All variable transformers can be strained with the maximum current over the entire operating range. The drive is given by a capacitor motor. 3 Neozed-elements are installed for protection. The transformers have each 5m connecting lead for connection to test bay inserts.

An additional slide-in unit can be used for test applications that require fixed or variable DC voltage. This slide-in unit is fed from the laboratory terminals U1 – V1 – W1 of the 36-2A or 36-3A slide-in test bay via a three-phase variable toroidal transformer. Alongside its direct current supply function this setup allows wide-ranging tests to be carried out.

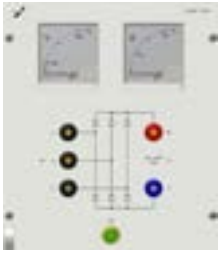

Technical data

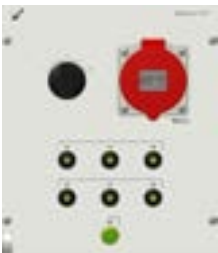
Description			Order no.
<p>Rectifier panel 6HU / 2WU 6HU / 42HP</p>		<p>Plug-in module with 3- phase rectifier Input: 3 x 0...400 V AC / 50 Hz Output: 0...500 V / 25 A DC 1 Moving-coil voltmeter 0...500 V 1 Moving-coil ammeter 0...25 A Residual ripple of DC: approx. 5% for 3-phase connection approx. 48 % for AC connection 3 screw type lab terminals for 3- phase supply 2 screw type lab terminals for tapping off DC output voltage 1 PE screw type lab terminal</p>	36-2B
<p>Rectifier panel 6HU / 2WU 6HU / 42HP</p>		<p>Plug- in module with 3- phase bridge rectifier Input: 3 / N / PE 0...400 V AC / 50 Hz Output: 0...500 V / 40 A DC Moving-coil voltmeter 0...500 V Moving-coil ammeter 0...40 A Residual ripple of DC: approx. 5% for 3-phase connection approx. 48 % for AC connection 3 screw type lab terminals for 3- phase supply 2 screw type lab terminals for tapping off DC output voltage 1 PE screw type lab terminal</p>	36-2C
<p>Pole- changing switch 6HU / 2WU 6HU / 42HP</p>		<p>Insert panel with: 1 Dahlander pole changing switch 40 A 6 screw type lab terminals 63 A, arranged in terminal board layout 1 5- pole CEE- socket outlet 63 A 1 PE- screw type lab terminal</p> <p>The panel is used in combination with test panels 36-2A e.g. 36-3A</p>	36-2D

6HU

DC-power supply, fixed

G3.4

DC-power supply

Regulated DC power supplies with stabilization byzed DC output in voltage and current regulated versions. The floating outputs are short circuit protected and can be connected in series or in parallel.

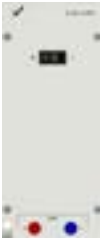

Technical data

Description		Order no.
Regulated DC stabilizer 6HU / 1WU 6HU / 21HP		32-1D
Regulated DC stabilizer 6HU / 1WU 6HU / 21HP		32-5M 32-5N 32-5P

6HU

DC-power supply, adjustable

G3.5

Smart DC Lab Power Supply Systems

with arbitrary function

6HU



Digital version



Touch version

Highlights

- Master-slave operation
- Parallel operation (0–4A)
- Serial operation (0–60V)
- Tracking operation ($\pm 30V$)
- Predefined curve progressions for sine, square, triangle, sawtooth, PWM
- Arbitrary function for free programming of voltage and current progressions
- Output limitation, password-protected
- Predefinable power-ON values
- Ethernet and USB interfaces
- Integrated web server for simple remote control via web browser
- 1 or 2 channels

Smart DC Lab Power Supply Systems

with arbitrary function

Arbitrary function

The lab power supply units have an arbitrary function that makes it possible to program and execute pre-determined functions or freely definable voltage and power curves.

The following functions can be selected:

- Sine
- Square
- Triangle
- Sawtooth
- PWM



The freely programmable mode makes it possible to program up to 6 curves each with 99 support points. In this mode, one always presets the start value and end value for current and voltage, and also the duration. In the automatic and rotary switch versions, the arbitrary function can be used only via the interface.

Power class	120W	120W	300W	600W
Feature				
Channel	2	2	1	1
Voltage	2x0...30V	2x0...30V	0...30V	0...60V
Current	2x0...2A	2x0...2A	0...10A	0...10A
Size	3HU / 42HP	6HU / 2WU	3HU / 66HP	6HU / 2WU
Version:				
Automatic	45-6R	–	45-6G	–
Digital	45-7R	34-7T	45-7G	34-7L
Touch	45-8R	34-8T	45-8G	34-8L

Smart DC Laboratory Power Supply System

2 x 0...30V / 0...2A / 120W

6HU



34-7T



34-8T

Highlights

- 4 operating modes for master-slave operation/dual output voltage (0–60V)/dual output current (0–4A)/ symmetrical voltage supply ($\pm 30V$)
- Output limitation, password-protected
- Predefinable power-ON values
- Direct and remote control operation in parallel possible
- Interference voltage protection
- Ethernet and USB interfaces
- Integrated web server
- Arbitrary function

Scope of delivery

34-xT.3 Plug-in module 6HU / 2WU

Accessories:

- 83-5B ZBL Safety test lead, blue, 100mm
- 83-5B ZRT Safety test lead, red, 100mm

Recommended additional products:

Elabo software package Elution® Device
Elution® device driver for Smart DC



Technical data

Voltage	
Output voltage	2 x 0...30V
Adjusting resolution	10 mV
Adjusting precision	± 3 digits (typ. ± 2 digits)
Measuring accuracy	0.15 % (display ± 3 digits)
Residual ripple	typ. 0.75 mV _{eff} max. 1mV _{eff}
Current	
Output current	2 x 2 A
Adjusting resolution	10 mA
Adjusting precision	± 3 digits (typ. ± 2 digits)
Measuring accuracy	0.15% (display ± 3 digits)
Arbitrary function	
Number of support points	6 x 99 support points
Structure of support points	Start/stop voltage, start/stop current, time
Predefined curves for	Sine, triangle, square, sawtooth and more (up to 10Hz)
Operation	Rotary switch version via interface/Elution® software, Touch version: via display
General information	
Stability over 8 hours	0.3 %
Adjusting resolution	12 bit
Protection	Short circuit-proof, thermal overload protection, interference voltage protection
Output insulation	Ungrounded and isolated ± 250 V to ground
Humidity	25–75% rel. humidity
Operating temperature range	0...50 °C
Line voltage	230 V ± 10 %, 49–61 Hz
Display	Rotary switch version 2x two-line LCD, blue Touch operation 4.3" x 128 pixels, blue
Interface	Ethernet and USB, RS232 alternative to USB
Degree of protection	Protection class I (EN61010-1)
Power consumption	140 W
Cassette dimensions	W = 229 mm, D = 260 mm, H = 266 mm
Weight	5.5 kg

Smart DC Laboratory Power Supply System

0...60 V / 0...10A / 300W

6HU



34-7L



34-8L

Highlights

- Output limitation, password-protected
- Display for voltage, current and power
- Predefinable power-ON values
- Direct and remote control operation in parallel possible
- Interference voltage protection
- Ethernet and USB interfaces
- Integrated web server
- Arbitrary function

Scope of delivery

34-xL.3 Slide-in module 6HU / 2WU

Accessories:

83-5B ZBL Safety test lead, blue, 100mm
83-5B ZRT Safety test lead, red, 100mm

Recommended additional products:

Elabo software package Elution® Device
Elution® device driver for Smart DC



Smart DC Laboratory Power Supply System

0...60 V / 0...10A / 600W

6HU

Technical data

Voltage	
Output voltage	0...60 V
Adjusting resolution	10 mV
Adjusting precision	± 3 digits (typ. ± 2 digits)
Measuring accuracy	0.15% (display ± 3 digits)
Residual ripple	< 2 mV _{eff}
Current	
Output current	0...10 A
Adjusting resolution	10 mA
Adjusting precision	± 3 digits (typ. ± 2 digits)
Measuring accuracy	0.15 % (display ± 3 digits)
Residual ripple	< 1 mA _{eff}
Arbitrary function	
Number of support points	6x99 support points
Structure of support points	Start/stop voltage, start/stop current, time
Predefined curves for	Sine, triangle, square, sawtooth and more (up to 10Hz)
Operation	Rotary switch version: via interface/Elution® software Touch version: via display
General information	
Stability over 8 hours	0,3 %
Adjusting resolution	12 bit
Protection	Short circuit-proof, thermal overload protection, interference voltage protection
Output insulation	Ungrounded and isolated ± 250V to ground
Humidity	25–75 % rel. humidity
Operating temperature range	0...50 °C
Line voltage	230 V ± 10 %, 49–61 Hz
Display	Rotary switch version 2x two-line LCD, blue Touch operation 4.3" x 128 pixels, blue
Interface	Ethernet and USB, RS232 alternative to USB
Degree of protection	Protection class I (EN61010-1)
Power consumption	690 W
Cassette dimensions	W = 229 mm, D = 260 mm, H = 266 mm
Weight	19.3 kg

Laboratory power supply unit

0...30 V / 0...20 A / 600 W

6HU

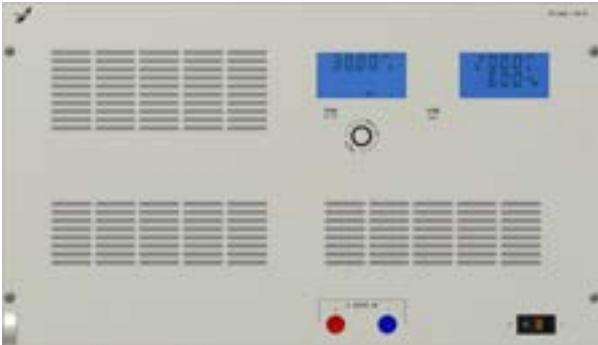

34-7J

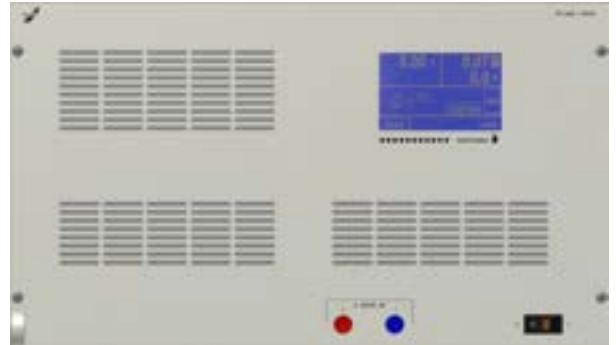

34-8J

Highlights

- Output limitation, password-protected
- Display for voltage, current and power
- Predefinable power-ON values
- Direct and remote control operation in parallel possible
- Interference voltage protection
- Ethernet and USB interfaces
- Arbitrary function
- Power output with On/Off function

Scope of delivery

- 34-xJ.3 Plug-in module 6HU / 4WU
- 34-xJ.K Plug-in module 6HU / 88HP

Recommended additional products

- Elabo software package Elution® device
- Elution® Device driver DC



Laboratory power supply unit

0...30 V / 0...20 A / 600 W

6HU

Technical data

Voltage	
Output voltage	0 ... 30 V
Adjusting resolution	10 mV
Adjusting precision	± 3 Digits (type ±2 Digits)
Measuring accuracy	0.15 % (Display ± 3 Digits)
Residual ripple	<2 mVeff
Current	
Output current	0...20 A
Adjusting resolution	1 mA
Adjusting precision	± 3 Digits (type ± 2 Digits)
Measuring accuracy	0.15 % (Display ± 3 Digits)
Residual ripple	< 1 mAeff
Arbitrary function	
Number of support points	6 x 99 Support points
Structure of support points	Start/stop voltage, start/stop current, time
Predefined curves for	Sinus, Triangle, Square, Sawtooth, and more (up to 10Hz)
Operation	Rotary switch version, automatic version: via interface/ Elution® software, Touch version: via display
General information	
Regulation	Linear regulator with stepped pre-control
Stabilization by over 8 hours	0,3 %
Adjusting resolution	12 bit
Protection	Short circuit-proof, thermal overload protection, interference voltage protection
Output insulation	Floating and isolated ±250 V to ground
Humidity	25 - 75 % rel. humidity
Operating temperature range	0 . . 50 °C
Mains supply	230 V ± 10 %, 49 - 61 Hz
Display	Rotary switch version 2x two-line LCD, blue Touch operation 4,3" 240 x 128 Pixel, blue
Interface	Ethernet and USB, RS232 alternative to USB
Degree of protection	Protection class I (EN61010-1)
Power consumption	690 W
Cassette dimensions	W =464 mm, D =260 mm, H = 266 mm
Weight	28,4 kg

Laboratory power supply unit

0 ... 300 V / 0 ... 4 A / 1200 W

6HU

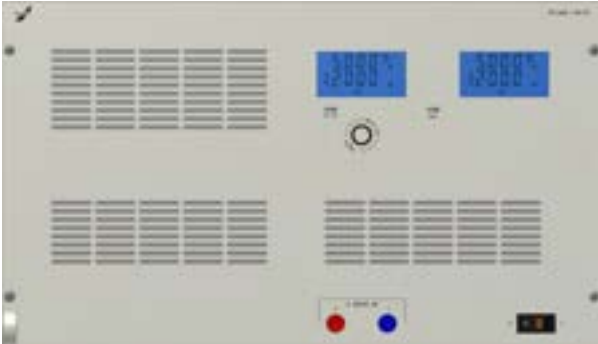

34-7Q

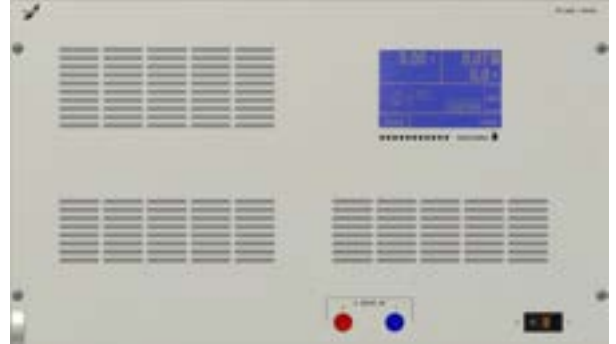

34-8Q

Highlights

- Output limitation, password-protected
- Display for voltage, current and power
- Predefinable power-ON values
- Direct and remote control operation in parallel possible
- Interference voltage protection
- Ethernet and USB interfaces
- Arbitrary function
- Power output with On/Off function

Scope of delivery

34-xQ.3	Plug-in module 6HU / 4WU
34-xQ.K	Plug-in module 6HU / 88HP

Recommended additional products

N2-1A	Elabo software package Elution® device
N2-5A	Elution® Device driver DC

NET
networkable

Laboratory power supply unit

0 ... 300 V / 0 ... 4 A / 1200 W

6HU

Technical data

Voltage	
Output voltage	0 ... 300 V
Adjusting resolution	10 mV
Adjusting precision	± 3 Digits (type ± 2 Digits)
Measuring accuracy	0.15 % (Display ± 3 Digits)
Residual ripple	<2 mVeff
Current	
Output current	0...4 A
Adjusting resolution	1 mA
Adjusting precision	± 3 Digits (type ± 2 Digits)
Measuring accuracy	0.15 % (Display ± 3 Digits)
Residual ripple	< 1 mAeff
Arbitrary function	
Number of support points	6 x 99 Support points
Structure of support points	Start/stop voltage, start/stop current, time
Predefined curves for	Sinus, Triangle, Square, Sawtooth, and more (up to 10 Hz)
Operation	Digital version: via Interface / Elution Software Touch version: via Display
General information	
Regulation	Linear regulator with stepped pre-control
Stabilization by over 8 hours	0,3 %
Adjusting resolution	12 bit
Protection	Short circuit-proof, thermal overload protection, interference voltage protection
Output insulation	Ungrounded and isolated ± 250 V to ground
Humidity	25 - 75 % rel. humidity
Operating temperature range	0 . . 50 °C
Mains supply	230 V ± 10 %, 49 - 61 Hz
Display	Digital version 2 x LC-Display two-line, blue TouchOperation 4,3" 240 x 128 Pixel, blue
Interface	Ethernet und USB, RS232 alternative to USB
Degree of protection	Protection class I (EN61010-1)
Power consumption	1290 W
Cassette dimensions	W =464 mm, D =260 mm, H = 266 mm
Weight	37,9 kg

Laboratory power supply unit

0 ... 30 V / 0 ... 40 A / 1200 W

6HU

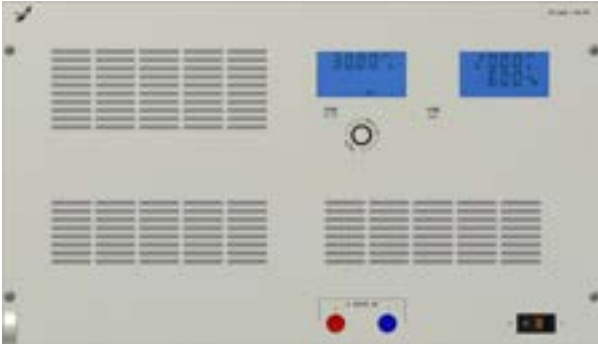

34-7N

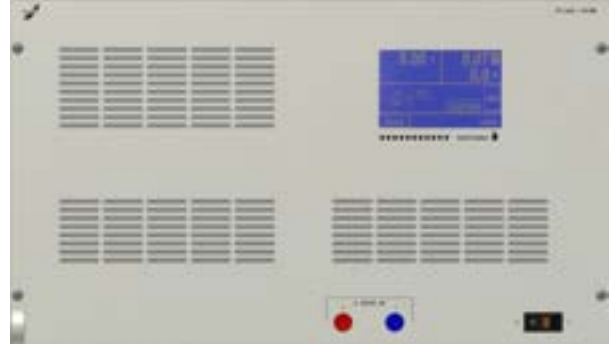

34-8N

Highlights

- Output limitation, password-protected
- Display for voltage, current and power
- Predefinable power-ON values
- Direct and remote control operation in parallel possible
- Interference voltage protection
- Ethernet and USB interfaces
- Arbitrary function
- Power output with On/Off function

Scope of delivery

34-xN.3	Plug-in module 6HU / 4WU
34-xN.K	Plug-in module 6HU / 88HP

Recommended additional products

Elabo software package Elution® device
Elution® Device driver DC



Laboratory power supply unit

0 ... 30 V / 0 ... 40 A / 1200 W

6HU

Technical data

Voltage	
Output voltage	0 ... 30 V
Adjusting resolution	10 mV
Adjusting precision	± 3 Digits (type ± 2 Digits)
Measuring accuracy	0.15 % ± 3 Digits
Residual ripple	< 2 mV _{eff}
Current	
Output current	0...40 A
Adjusting resolution	1 mA
Adjusting precision	± 3 Digits (type ±2 Digits)
Measuring accuracy	0.15 % ± 3 Digits
Residual ripple	< 1 mA _{eff}
Arbitrary function	
Number of support points	6 x 99 Support points
Structure of support points	Start/stop voltage, start/stop current, time
Predefined curves for	Sinus, Triangle, Square, Sawtooth, and more (up to 10Hz)
Operation	Digital version:via Interface / Elution Software Touch version:via Display
General information	
Regulation	Linear regulator with stepped pre-control
Stabilization by over 8 hours	0,3 %
Adjusting resolution	12 bit
Protection	Short circuit-proof, thermal overload protection, interference voltage protection
Output insulation	Floating and isolated ±250 V to ground
Humidity	25 - 75 % rel. humidity
Operating temperature range	0 . .50 °C
Mains supply	230 V ± 10 %, 49 - 61 Hz
Display	Digital version 2x LC-Display two-line, blue Touch operation 4,3" 240 x 128 Pixel, blue
Interface	Ethernet and USB, RS232 alternative to USB
Degree of protection	Protection class I (EN61010-1)
Power consumption	1290 W
Cassette dimensions	W =464 mm, D =260 mm, H = 266 mm
Weight	38,2 kg

G Electronics



System 6HU

Measuring- and signal devices

G3.6

Technical data

Description			Order no.
Continuity tester 6HU / 1WU 6HU / 21HP		Insert panel with two continuity Testers 1 electronic high-impedance continuity Tester up to a maximum of 5 MOhm (acoustic) Test current: maximum 25 μ A Voltage safety: bis ca. 400 V AC 1 low-impedance continuity Tester (optical) Test voltage: 22 V AC 1 Fine wire fuse 1 Illuminated rocker switch 1 Transformer with separate input windings and output windings 1 incandescent lamp 1 miniature loudspeaker 2 x 2 Safety lab terminals	32-1B
Continuity tester 6HU / 1WU 6HU / 21HP		Insert panel with low-impedance continuity Tester for testing switches; automatic cut-outs, etc.. 1 Incandescent lamp optical display 1 buzzer acoustic signal test voltage 22 V AC 3 Safety lab terminals 1 Illuminated rocker switch	32-1T
Digital multimeter 6HU / 1WU 6HU / 21HP		Insert panel with 3 3/4-digit DYNATEC 9200 digital multimeters Measurement range: DC 400 mV... 1000 V 400 μ A ... 20 A AC 400 mV ... 750 V 400 μ A ... 20 A R 400 Ohm... 40 MOhm F 4 kHz ... 4 MHz Base accuracy: \pm (0,5 % v. M. + 1 digits) Operating modes: Continuity testing Pulse duty factor test Logic test Data Hold Peak Hold incl. power supply for mains operation	32-2H Z007

Oscilloscope

Keysight InfiniVision 2000 X- and 3000 X- Series

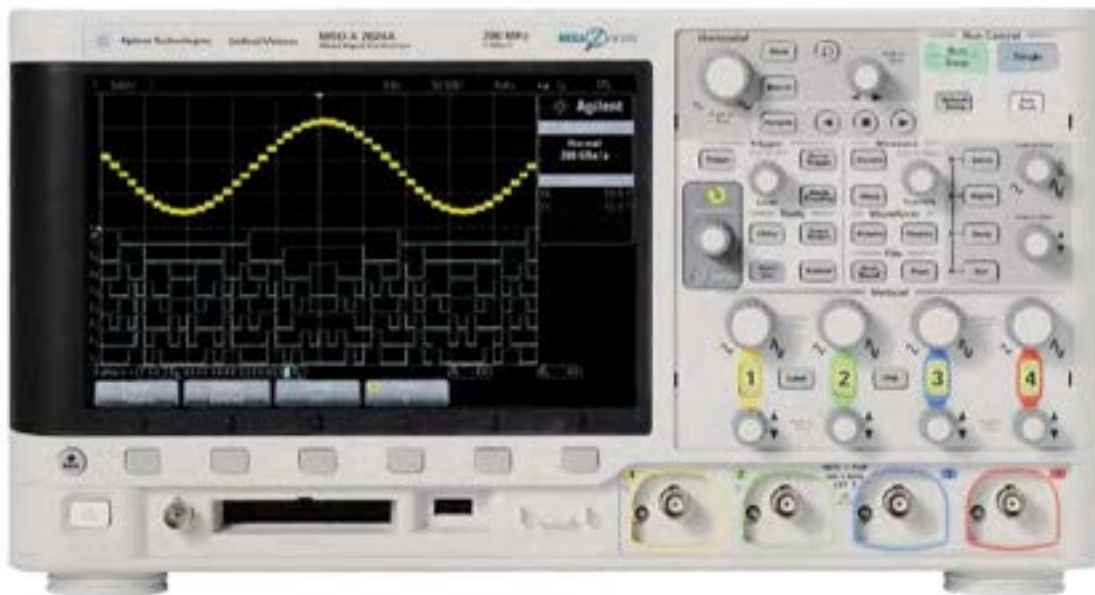

Highlights

- The Keysight InfiniVision can be installed either in 19" systems or alternatively in the 6HU device system
- Separate installation set available

Technical Data

	InfiniVision 2000 X Series	InfiniVision 3000 X Series
Analog channels	2 or 4 analog channels	
Digital timing channels	8 on MSO models or with upgrade DSOX2MSO	16 on MSO models or with upgrade DSOX2MSO
Bandwidth (extendable)	70, 100, 200MHz	100, 200, 350, 500MHz
Sampling rate	1 GSa/s per channel, 2 GSa/s with half number of channels (interleaved)	2 GSa/s per channel, 4 GSa/s with half number of channels (interleaved)
Memory depth	100kpts	2 Mpts as standard, 4 Mpts optional (option DSOX3MemUp)
Signal Update rate	50000 signals/s	1000000 signals/s
Built-in 20 MHz WaveGen function generator	Yes (option DSOX2WAVEGEN)	Yes (option DSOX3WAVEGEN)
Search and navigation functions	No	Yes
Analysis of serial protocols	No	Yes (several options)
Segmentable memory	Yes (option DSOX2SGM)	Yes (option DSOX3SGM)
Alarm mask test	Yes (option DSOX2MASK)	Yes (option DSOX3MASK)
AutoProbe interface	No	Yes

More technical details can be found in the Keysight data sheets.

Oscilloscope

Keysight InfiniiVision 2000 X- and 3000 X- Series

Model variants

InfiniiVision 2000 X-Series

Type (Keysight)	Description	Bandwidth
DSOX2002A	Oscilloscope, Digital, 2-Channel	70 MHz, 2 x 1 GS/s
DSOX2004A	Oscilloscope, Digital, 4-Channel	70 MHz, 4 x 1 GS/s
DSOX2012A	Oscilloscope, Digital, 2-Channel	100 MHz, 2 x 1 GS/s
DSOX2014A	Oscilloscope, Digital, 4-Channel	100 MHz, 4 x 1 GS/s
DSOX2022A	Oscilloscope, Digital, 2-Channel	200 MHz, 2 x 1 GS/s
DSOX2024A	Oscilloscope, Digital, 4-Channel	200 MHz, 4 x 1 GS/s
MSOX2002A	Oscilloscope, Mixed, 2-Channel	70 MHz, 2 x 1 GS/s
MSOX2004A	Oscilloscope, Mixed, 4-Channel	70 MHz, 4 x 1 GS/s
MSOX2012A	Oscilloscope, Mixed, 2-Channel	100 MHz, 2 x 1 GS/s
MSOX2014A	Oscilloscope, Mixed, 4-Channel	100 MHz, 4 x 1 GS/s
MSOX2022A	Oscilloscope, Mixed, 2-Channel	200 MHz, 2 x 1 GS/s
MSOX2024A	Oscilloscope, Mixed, 4-Channel	200 MHz, 4 x 1 GS/s

InfiniiVision 3000 X-Series

Type (Keysight)	Description	Bandwidth
DSOX3012A	Oscilloscope, Digital, 2-Channel	100 MHz, 2 x 2 GS/s
DSOX3014A	Oscilloscope, Digital, 4-Channel	100 MHz, 4 x 2 GS/s
DSOX3024A	Oscilloscope, Digital, 4-Channel	200 MHz, 4 x 2 GS/s
DSOX3032A	Oscilloscope, Digital, 2-Channel	350 MHz, 2 x 2 GS/s
DSOX3034A	Oscilloscope, Digital, 4-Channel	350 MHz, 4 x 2 GS/s
DSOX3052A	Oscilloscope, Digital, 2-Channel	500 MHz, 2 x 2 GS/s
DSOX3054A	Oscilloscope, Digital, 4-Channel	500 MHz, 4 x 2 GS/s
MSOX3012A	Oscilloscope, Mixed, 2-Channel	100 MHz, 2 x 2 GS/s
MSOX3014A	Oscilloscope, Mixed, 4-Channel	100 MHz, 4 x 2 GS/s
MSOX3024A	Oscilloscope, Mixed, 4-Channel	200 MHz, 4 x 2 GS/s
MSOX3032A	Oscilloscope, Mixed, 2-Channel	350 MHz, 2 x 2 GS/s
MSOX3034A	Oscilloscope, Mixed, 4-Channel	350 MHz, 4 x 2 GS/s
MSOX3052A	Oscilloscope, Mixed, 2-Channel	500 MHz, 2 x 2 GS/s
MSOX3054A	Oscilloscope, Mixed, 4-Channel	500 MHz, 4 x 2 GS/s

More technical details can be found in the Keysight data sheets.

Order number	Description
35-4S ZEBS	Insert panel 6HU/4WU installation set for Agilent InfiniiVision (Elabo system 6HU)
55-4S ZEBS	Insert panel 19"/5HU installation set for Agilent InfiniiVision (Elabo system Primus One)
35-4S Zxxxxx	Agilent InfiniiVision oscilloscope (please quote the desired model number when ordering)

Technical data

Description			Order no.
Oscilloscope 6HU / 3WU (+ 1WU) 6HU / 88HP		Insert panel digital Real-Time Oscilloscope Tektronix, Type TDS 2002B colour display (1/4 VGA LCD) Digital Real Time (DRT) 60 MHz bandwidth 1 GS/s sample rate two input channels external triggering edge and video trigger capability triggerview cursor measurement with readout setup and waveform storage auto setup menued driven measurements USB interface front and backside	35-4P Z103-EBS 35-4P Z103-Module
Oscilloscope 6HU / 1WU 6HU / 21HP 		Insert panel 2-Channel PC-Oscilloscope Brand Metrix MTX1052 Bandwidth: 150MHz Channels: 2, Class 1 Common ground vertical 2,5 mV / div- 100 V / div bis 250 iV / div with Y-elongation time bases 35 areas of 1 ns / div...200 s / div Trigger: Auto, triggert, single-shot Triggerquelle: CH1, CH2, CH3, CH4, EXT, Netz Type: Flanke, impulse width or delay Mains supply: 100...230 V / AC 47..63 Hz Ethernet-Interface Software Available options: Differential voltage sensors	35-4Q Z102
Oscilloscope 6HU / 1WU 6HU / 21HP 		Insert panel 4-channel PC oscilloscope with Ethernet interface Mfr. Metrix MTX1054 The digital PC oscilloscope is easy to use and is operated completely with the included software Bandwidth: 150 MHz Channels: 4 channels, Class 1, Common ground vertical: 2.5 mV/div- 100 V/div, to 250 iV/div with Y-elongation time bases 35 areas of 1 ns/div to 200 s/div Trigger: Auto, triggered, single-shot Trigger source: CH1, CH2, CH3, CH4, EXT, network Type: Shoulder, impulse width or delay power supply: 100- 230 V/AC 47- 63 Hz Available options: Differential voltage sensors	35-4R Z102

G Electronics



System 6HU

High voltage tester

High voltage tester

The safety test instruments described here are used in high voltage testing applications and for measuring insulation and earth wire resistance. Such measurements are essential for equipment that must, subject to the applicable safety regulations, be checked by the manufacturer. Further equipment is also presented in our catalogue "Test Instruments".

6HU

Technical data

Description		Order no.
<p>High- voltage tester 6HU / 2WU 6HU / 42HP</p>		<p>37-3C</p> <p>Plug-in module with μP-controlled high voltage Tester for the voltage proof testing of electrical equipment, machines, components and insulating materials which according to relevant safety regulations, must be tested with a sinusoidal AC voltage.</p> <p>Operating modes: selectable by key switch "Test" overcurrent tripping release "Burn" burnout of faults "Timer" test time setting between 1...99s</p> <p>Display: 1 analogue moving coil instrument with double scale, switchable between current and voltage measurement</p> <p>Test voltage: 0...2.5 / 0...5 kV, steplessly adjustable</p> <p>Release current: 0...100 mA, steplessly adjustable</p> <p>Rated power: 500 VA Short- circuit current: > 200 mA Response: < 50 ms Mains supply: 230 V + 10% - 5% / 50 Hz / 600 VA Safety function: internally adjustable monitoring of basic current and minimum voltage Operating: by means of operating devices, located at the front panel Interface: for external control by means of floating relay contacts for fault monitoring and external safety circuit A special socket on the front panel enables an additional set of warning lamps to be connected.</p>

High voltage test equipment accessories

Technical data

Description		Order no.
Safety test probe		94-2A 4, 6, 10 and 15 m available upon request
Warning lamp set		94-2C Warning- lamp set to VDE 0104 with red and green warning lamps, special plug with 2,5 m lead
Footswitch		94-2D Z001 Footswitch with approx. 2.5 m suitably for High Voltage Tester 37-3C.

G Electronics



System 6HU

6HU

Combination test devices

G3.8

Technical data

Description		Order no.
<p>Isolation- and safety tester 6HU / 2WU 6HU / 42HP</p>	 <p>Plug-in module with two safety testing instruments:</p> <p>1 protective earth conductor measuring device 90-2A</p> <p>Test current: 10...25 A</p> <p>1 analogue divider that calculates and displays the resistance of the protective earth conductor and its connections from the voltage drop and the momentary value of the current flowing Measurement range: 0...0.3 Ohm</p> <p>1 spindle trimming potentiometer</p> <p>1 push-button enables the maximum permitted value of resistance to be set. If this value is exceeded during the measurement, a visual fault alarm is given. There is also a fault alarm given for too low or too high preset test currents (limit values are set inside the module).</p> <p>1 earth safety socket 2 screw terminals 2 safety lab terminals 1 DIN-jack for PE-test probe 94-4S 1 illuminated rocker switch</p> <p>1 insulation resistance tester 90-2E</p> <p>Test voltage: 500 V DC, stabilization bypassed Short circuit: maximum 3 mA (no further safety measures are necessary for the operator)</p> <p>1 analogue divider with highly accurate measurement of resistance. The resistance is displayed at two linear scales of the measurement instrument 0 ...10 MOhm 0..100 MOhm</p> <p>1 spindle trimming potentiometer, located at the front panel, for the setting of a bottom limit value of the insulation resistance. If a value below this limit is recorded during the test, a visual and an audible fault alarm are given.</p> <p>1 earth safety socket 2 safety lab terminals 1 illuminated rocker switch</p> <p>More variants find in chapter 3HU.</p>	<p>37-3G</p>

Technical data

Description			Order no.
<p>Safety tester VDE 0701/02 6HU / 2WU 6HU / 42HP</p>		<p>Safety tester according to VDE 0701/0702 Measuring functions:</p> <ul style="list-style-type: none"> - Protective conductor resistance - Insulation resistance - Substitute leakage current - Protective conductor and touch current - Power, voltage, current, power factor, frequency <p>Tester Information</p> <ul style="list-style-type: none"> • Intuitive operator guidance • Manual mode, automatic mode, test series mode • Test examination for the protection of the tester against defect specimens • Test o.k. or test not o.k. text message on screen • Test lead compensation • Ethernet interface <p>Technical Data:</p> <p>Protective conductor resistance 0.1...2.0Ohm Test current/voltage >200mA / > 4VDC Insulation resistance 0.2...20MOhm Test voltage/current $\geq 500\text{VDC}/>1\text{mA}$ Substitute leakage current 0.02...20 mA Test voltage approx. 230VAC Protective conductor current 0.25...20mA Touch current 0.1...2mA Measuring principle direct or as differential current Power 0... 3.7kVA Voltage 195...250V Current 0...16A Power factor 0 cap...1...0 ind. Power supply 230V +10%/-15% 50Hz</p> <p>Power supply 230 V +10%/-15% 50Hz</p> <p>W = 229 mm, H = 266 mm</p>	<p>37-2M.3Z002</p>

Motor test bay 120 kVA

The Elabo motor test bay is the ideal test facility for electrical engineering applications and for industrial electrical workshops. Our equipment is designed with the benefit of decades of testing experience which, in the hands of professional electrical engineers, makes it perfect for the safe and proper handling of continually changing testing requirements. Combined with the three-phase variable transformer and module ar auxiliary equipment the test bay is suitable not only for every possible testing application but for reliable diagnosis of almost all types of electrical equipment as well.



An Elabo motor test station comprises the following:

- Table superstructure with high-current and plug-in part
- 3-phase transformer unit
- Plug-in units of the 6HU system
- Work table with floor cabinet.

The body of the table superstructure housing is made from 19 mm laminate and coated on both sides with melamine resin in basalt gray. Removable rear wall of 2 mm sheet aluminium, body powdercoated. Mains connection and connection of the connecting lead for the on-site regulating transformer on labeled series terminal strip.

High-current part:

The high-current part contains all of the control and safety elements necessary for operation as well as the protective combinations for the selectable power and voltage ranges. The installed large analog current measurement devices are equipped with linear scales. Overlapping measuring ranges make optimum resolution possible. Parallel to this, all of the important network parameters can be measured with the CVM power analyzer with the 3-fold digital display.

Other measuring and testing equipment:

Depending on the application, a variety of measuring and testing devices can be additionally integrated into the design, for example, high-voltage test equipment.

Versatile use:

The combination of high-current unit, 3-phase transformer unit and the modular plug-in field render possible versatile tests of motors, transformers and devices using small and large capacity:

- Check of electrical machines of all types
- Stator and rotor testing even when uninstalled
- Heating of windings for drying or impregnation
- Error Detection in the event of inter-turn short-circuit
- Power and voltage supply systems for 1-phase, 3-phase and DC devices
- Carrying out safety tests according to existing DIN standards on electrical components of all kinds

Motor test bay- high current section



Technical data:

Mains connection:	3 / N / PE ~ 50 Hz 400 V on labeled terminal block
Main switch:	Key-operated switch, usable as emergency stop switch at the same time
Protection:	Motor protection circuit breaker with undervoltage trip in the range from 160...200 A
Control circuit:	All control circuits are protected by triple automatic circuit breakers.
Current display:	3 moving coil ammeters 144 mm x 144 mm with measurement rectifier and linear double scale
Current Ranges:	1,5 A, 5 A, 15 A, 50 A, 100 A
Voltage Ranges:	I 3 / N / PE ~ 50 Hz / 0...230 V II 3 / N / PE ~ 50 Hz / 0...450 V III 3 / N / PE ~ 50 Hz / 0...690 V each range up to 100 A, transient 150 A
Multipurpose display:	Microprocessor controlled analyser with 16 mm high independent displays. Up to 30 parameters can be selected, e.g.: <ul style="list-style-type: none"> - Simultaneous measurement of the voltage of all phases - Simultaneous measurement of current flows of all phases - Current measurement in the neutral core - Active power measurement (W) - Reactive power measm. (VAr kap, VAr ind) - Apparent power measurement (VA) - Power factor measurement - Frequency (Hz)
Tapping off:	1 Schuko Socket 1 CEE-Socket 3-pole 16 A, blue 3 CEE-Sockets 5-pole 16 A, 32 A, 63 A, red 8 high-current lab terminals, arranged in the terminal board 1 Star-Delta reverse switch 100 A with zero position
DC-Power supply:	I 0... ca. 150 V II 0...ca. 300 V III 0...ca. 450 V Residual ripple of DC 18 %
DC-VoltageDisplay:	Moving-coil voltmeter 144 mm x 144 mm with double scale, 100 V, double scale 500 V
DC-CurrentDisplay:	Moving-coil ammeter 144 mm x 144 mm with double scale 10 A double scale 100 A
Protection:	SILIZED fuse 100 A internally

Motor test bay transformer aggregat 3-phase



Technical data:

Power rating:	120 kVA
Input voltage:	3 / N / PE 400 V AC / 50 Hz
Output voltage:	I 3 ~ 0...133 / 230 V II 3 ~ 0...260 / 450 V III 3 ~ 0...400 / 690 V
Current output:	maximum 100 A within each voltage range, transient 150 A
Cooling:	Natural air cooling
Housing:	steel sheet
Degree of protection:	IP 20
Drive:	24 V DC with speed control by means of 10- turn potentiometer
Actuating time:	approx. 10 ... 80 s, steplessly adjustable
Weight:	ca. 1200 kg
Ambient temperature:	40 °C
Dimensions:	W = approx. 1200 mm, D = approx. 1000 mm, H = approx. 1800 mm

3- phase variable column autotransformer with separate windings according to VDE 0552 part 5 for heavy- duty operation. The transformer has to be installed separately from the bench and be connected by means or flexible cables. Connection to terminal block fitted in the bench rack.

The unit is tailored to the individual customer's order.

Order no. 36-2P

Pneumatics

G3.9

Pneumatics compressor, vacuum pump



Elabo has a comprehensive range of pressure supplies and vacuum generators; this is supplemented with test and measurement equipment. The diversity of pneumatic equipment for System 6HU slide-in units can be expanded by using Subrack 31-4A or 31-4B to take supply units from the System 3HU euromodules. Special pressure ranges are available for the slide-in pneumatic units. Custom designs are also possible, e.g. special couplings, water pressure measurement, flow rate meters etc.

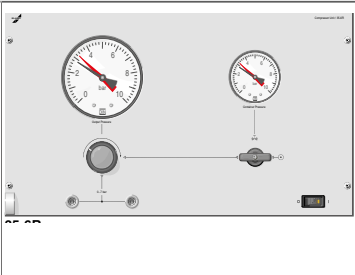
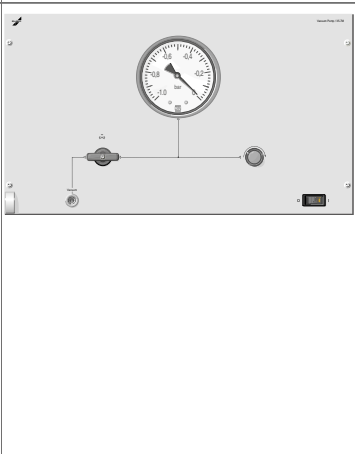

Technical data

Description		Order no.	
<p>Oil-free compressor 6HU / 4WU 6HU / 88HP</p>		<p>Plug-in panel module with non lubrication compressor to generate shop air. Rated pressure: 7 bar Capacity: 35 l / min Sound pressure level: 57 dB (A)</p> <ul style="list-style-type: none"> 1 pressure regulator 2 manometer 2 couplings NW5 2 quick connectors 	<p>35-6R</p>
<p>Oil-free vacuum pump 6HU / 4WU 6HU / 88HP</p>		<p>Plug-in panel module with non-lubrication vacuum pump Capacity: 32 l / min Generated vacuum: approx. 850 mbar Range: approx. 850...133 mbar (ca. 700...100 Torr) Accuracy: ca. 13 mbar (10 Torr) Mains supply: 230 V / 50 Hz Sound pressure level: ca. 57 dB (A)</p> <ul style="list-style-type: none"> 1 Manometer 1 coupling NW5 1 quick connector 	<p>35-7M</p>

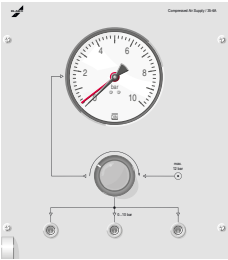
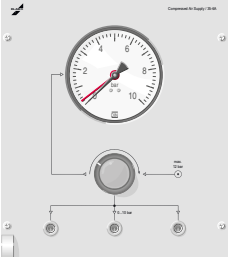
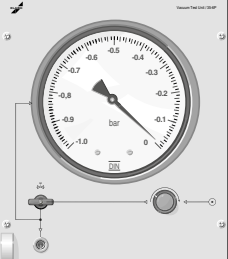
Technical data

Description			Order no.
Pneumatic supply unit 6HU / 2WU 6HU / 42HP		Plug-in module with compressed air supply module 1 Flange- mounted pressure gauge 0...10 bar 1 Pressure regulator 0,5...10 bar 3 couplings NW5 2 Quick connectors 1 connecting hose	35-6A
Pneumatic supply unit 6HU / 2WU 6HU / 42HP		Plug-in module with compressed air supply module 1 flange- mounted pressure gauge 0,5...10 bar with water separator and oil misting unit 1 Pressure regulator 3 couplings NW5 2 Quick connectors 1 connecting hose	35-6B
Pneumatic supply unit 6HU / 2WU 6HU / 42HP		Plug-in module with vacuum precision gauge 1 analogue precision gauge of quality class 0.6, range 0...1000 mbar 1 Precision pressure regulator with good adjustment accuracy and reproducibility for a correct setting of the output vacuum 1 coupling NW5 1 quick connector Vacuum has to be provided!	35-6P
Pneumatic measurement and test unit 6HU / 2WU 6HU / 42HP		Plug-in module with pressure gauge to be used as a regulator (for pressure setting) or as an external measuring instrument and for leak testing. Input pressure maximum 12 bar. 1 precision manometer 0...1 bar, class 0.6 1 precision pressure regulator 1 3/2 valve to perform leak testing 1 3/2 valve to switch over from internal measurements to external use 2 self sealing couplings NW5 1 Quick connectors Pressure to be supplied on site!	0...1,0 bar 35-6C Z01 0...2,5 bar 35-6C Z02 0...6,0 bar 35-6C Z03 0...10,0 bar 35-6C Z04

Technical data

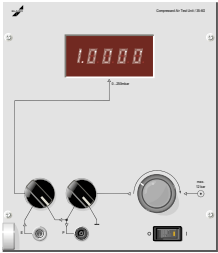
Description		Order no.
Pneumatic measurement and test unit 6HU / 2WU 6HU / 42HP	 <p data-bbox="836 427 1299 568">Plug- in module with pressure gauge with digital indicator to be used as a regulator (for pressure setting) or as an external measuring instrument and for leak testing. Output pressure can be set very precisely. Input pressure maximum 12 bar.</p> <ul data-bbox="836 600 1299 860" style="list-style-type: none"> 1 digital display 4½ digit 1 piezo- resistive precision transmitter, class 0.15 1 precision pressure regulator 1 3/2 valve to perform leak testing 1 3/2 valve to switch over from internal measurements to external use 2 self sealing couplings NW5 1 Quick connectors <p data-bbox="836 837 1139 860">Pressure to be supplied on site!</p>	<p data-bbox="836 981 1458 1010">0...250 mbar 35-6G Z01</p> <p data-bbox="836 1039 1458 1068">0...1 bar 35-6G Z02</p> <p data-bbox="836 1097 1458 1126">0...2 bar 35-6G Z03</p> <p data-bbox="836 1155 1458 1184">0...4 bar 35-6G Z04</p> <p data-bbox="836 1214 1458 1243">0...6 bar 35-6G Z05</p> <p data-bbox="836 1272 1458 1301">0...10 bar 35-6G Z06</p>





Five different measuring ranges can be covered: 0 ... 1 bar, 0 ... 2.5 bar, 0 ... 4 bar 0 ... 6 bar and 0 ... 10 bar. With the help of three 2/2-way valves, each of which has a measurement range allocated to it, the set test pressure is routed directly to the rapid-action output hose coupling. The internal compressed air pressure is displayed by an additional small manometer.

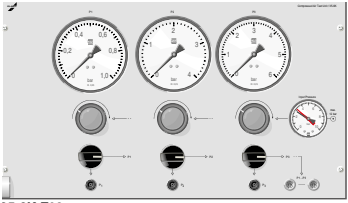
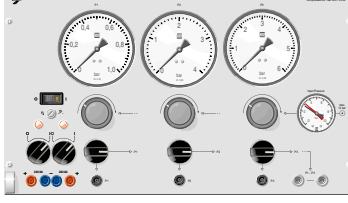

Technical data

Description		Order no.
<p>Pneumatic measurement module 6HU / 4WU 6HU / 42HP</p>	 <p>Plug-in module to check pneumatic or electro-pneumatic control components and transmitters. Input pressure maximum 12 bar.</p> <ul style="list-style-type: none"> 3 analogue gauges, class 1.0 <ul style="list-style-type: none"> 0...1 bar, 0...4 bar, 0...6 bar 1 Pressure gauge 0...10 bar to check input pressure 3 precision pressure regulators 3x 2/2-way valves to select output couplings 5 self sealing quick couplings NW5 3 Quick connectors <p>0...1 / 2,5 / 6 bar</p> <p>0...2,5 / 4 / 6 bar</p> <p>0...1 / 4 / 6 bar</p> <p>Other ranges available on request.</p>	<p>35-6K Z01</p> <p>35-6K Z02</p> <p>35-6K Z03</p>
<p>Pneumatic measurement module 6HU / 4WU 6HU / 42HP</p>	 <p>Plug-in module to check pneumatic or electro-pneumatic control components and transmitters. Input pressure maximum 12 bar. Input pressure maximum 12 bar.</p> <ul style="list-style-type: none"> 3 small pressure gauge 0...10 bar to check input pressure <ul style="list-style-type: none"> 0...1 bar, 0...4 bar, 0...6 bar 1 Pressure gauge 0...10 bar to check input pressure 3 precision pressure regulators 3 x 2/2-way valves to select output couplings 5 self sealing quick couplings NW5 3 Quick connectors 1 additional DC supply with output voltage <ul style="list-style-type: none"> 2 x 24 V, 4 A total output current (for both outputs), residual ripple 48%. 2 switches 2 x 2 safety lab terminals 1 circuit breaker 1 Illuminated rocker switch <p>0...1 / 2,5 / 6 bar</p> <p>0...2,5 / 4 / 6 bar</p> <p>0...1 / 4 / 6 bar</p> <p>Other pressure ranges and output voltage ranges available on request.</p>	<p>35-6L Z01</p> <p>35-6L Z02</p> <p>35-6L Z03</p>

Technical data

Description		Order no.
Connector hose 6/4 mm		single Quick connectors NW5, 10 bar, 500 mm single Quick connectors NW5, 10 bar, 1000 mm single Quick connectors NW5, 10 bar, 2000 mm single Quick connectors NW2,5, 10 bar, 500 mm single Quick connectors NW2,5, 10 bar, 1000 mm single Quick connectors NW2,5, 10 bar, 2000 mm
Manometer connectors		R 1/8" R 1/4" R 3/8" R 1/2"
High pressure hose DN4		Minimesh-connections, 400 bar, 630 mm Minimesh-connections, 400 bar, 1000 mm
Plug nipples for single-handed rapid-action connectors		NW5 for coupling hose 6/4 mm NW2,5 for coupling hose 6/4 mm
10 bar air supply for bench rack plug-in modules		Coupling type 3 Coupling type 5

6HU

Decades & logades

G3.10

Technical data

Description		Order no.	
R-decade 6HU / 1WU 6HU / 21HP		<p>Insert panel with 6- decade resistance setting</p> <p>Range: 1 Ohm...999,999 kOhm</p> <p>Resolution:1 Ohm</p> <p>Tolerance: 1 Ohm...9 Ohm < 10 % + 0,9 Ohm 10 Ohm...99 Ohm < 2 % + 0,9 Ohm 100 Ohm...999 Ohm < 1 % + 0,9 Ohm ≥ 1000 Ohm < 1 %</p> <p>Load: maximum 1 W</p> <p>Voltage: maximum 250 V AC / maximum 50 V DC</p> <p>6 preset switches to set resistance values</p> <p>2 Safety lab terminals</p>	32-2A
C-decade 6HU / 1WU 6HU / 21HP		<p>Insert panel with 5 C-decade setting</p> <p>Range: 100 pF...9,9999 μF</p> <p>Resolution:100 pF</p> <p>Tolerance:</p> <p>100 pF...1000 pF: ± 10 % type ± 13 % max.</p> <p>100 pF... 9,9 nF: ± 5 % type ± 8 % max.</p> <p>10 nF...99,9 nF: ± 3 % type ± 5 % max.</p> <p>1 μF...9,99 μF: ± 2 % type ± 5 % max.</p> <p>Operating voltage: maximum 50 V DC</p>	32-2B
Inductive logade 6HU / 1WU 6HU / 21HP		<p>Insert panel with logarithmic interval inductances 1 μH...4700 μH</p> <p>Ranges: 23 values between 1 μH...4700 μH are provided</p> <p>Inaccuracy: 1 μH...33 μH ± 10 % 47 μH...4700 μH ± 5 %</p> <p>Operating voltage: maximum 100 V DC</p> <p>Operating voltage: maximum 63 mA protected by fine wire fuse</p> <p>1 rotary knob for setting required values</p> <p>2 Safety lab terminals</p>	32-2C

Technical data

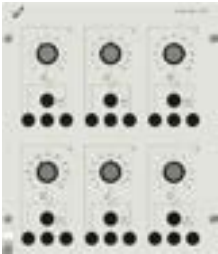
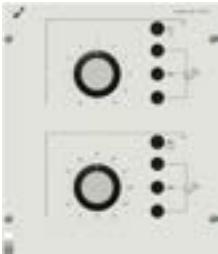
Description			Order no.
Load resistances 6HU / 2WU 6HU / 42HP		Plug-in module with 6 adjustable load resistance 0...100 % Standard values: 10 Ohm, 47 Ohm, 100 Ohm, 470 Ohm, 1 kOhm, 10 kOhm Rating: maximum 50 W; other values on request 6 Fine wire fuses 6x 3 Safety lab terminals	33-0F
Load resistances 6HU / 2WU 6HU / 42HP		Plug-in module with 2 Load resistance, stepless adjustable 0...100 %; Standard values: 10 Ohm, 1 kOhm Load: maximum 250 W; other values on request 2 Fine wire fuses 2x 3 Safety lab terminals	33-0G

G Electronics



System 6HU





Interfaces

G3.11

Adjustable AC-supply, special Insert panel

6HU

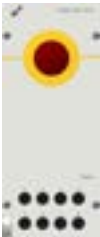
Technical data



Description			Order no.
Antenna socket 6HU / 1WU 6HU / 21HP		Insert panel with antenna socket 2 Schuko sockets 1 antenna socket TV, SAT, Radio	32-1K
Selectable pole 6HU / 1WU 6HU / 21HP		Insert panel with 15 non-wired laboratory safety sockets as selectable pole with labelling 1 to 15	32-1U
Selectable pole and emergency off switch 6HU / 1WU 6HU / 21HP		Insert panel with 8 laboratory safety sockets as selectable pole with labelling 1..8 1 non-wired emergency off switch with snap-on contact and signal ring	32-1Q
Multiple interface panel 6HU / 1WU 6HU / 21HP		Insert panel with 2 USB connectors, type A female 2 PS/2 Mini-DIN 6-pin connectors, female 1 Sub-D connector 9-pole male 1 Sub-D connector 15-pole HD female each with approx. 2 m connection cable and mating connector 2 jack sockets, 3.5mm stereo with approx. 3m connection cable and mating connector 2 RJ45 socket 8-pin, pluggable on both sides	32-1U Z001

6HU

Soldering station

G3.12

Technical data

Description			Order no.
Soldering station 6HU / 1WU 6HU / 21HP		Insert panel with temperature-regulated soldering station 80W ideal for lead-free soldering, RoHS-compliant Temperature range: 150...400°C, continuously variable and electronically regulated 1 Schuko Socket 1 Soldering iron 810 CDJ 1 Stand A41 1 Illuminated rocker switch	32-1W
Soldering station 6HU / 1WU 6HU / 21HP		Insert panel with electronically regulated soldering station 80W, manufactured by Weller, ideal for lead-free soldering, RoHS-compliant Temperature range: up to 450°C, continuously variable and electronically regulated 1 LED for regular visual inspection 1 Schuko Socket 1 Soldering iron 1 Stand 1 Illuminated rocker switch	32-1Y

6HU



Housing und accessories

G3.13

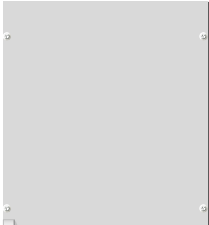

Blank plate, push-in shelf

6HU

Technical data

Description		Order no.
Blank panel 6HU / 1WU 6HU / 21HP		31-1A
Blank panel 6HU / 2WU 6HU / 42HP		31-1B
Blank panel 6HU / 4WU 6HU / 88HP		31-1C
Blank panel Primus One		31-0L.KxxTe Please specify desired HP
Blank panel 6HU / 2WU 6HU / 42HP		31-2B
Blank panel 6HU / 4WU 6HU / 88HP		31-2C
Push-in shelf 6HU / 4WU 6HU / 88HP		31-2F
Push-in shelf 6HU / 6WU 6HU / 135HP		31-2G

Technical data

Description			Order no.
Subrack 6HU / 2WU 6HU / 48HP		Subrack for holding insert panels or eurocassettes 3HU / 2 x 36HP	31-4A
Subrack 6HU / 4WU		Subrack for holding insert panels or eurocassettes 3HU / 2 x 84HP	31-4B
Subrack Primus One 6HU / 96HP		Subrack for holding insert panels or eurocassettes 3HU / 2 x 84HP	31-4B.K



Housing

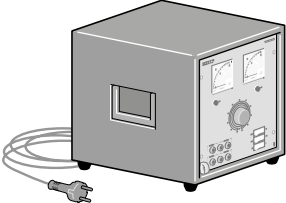
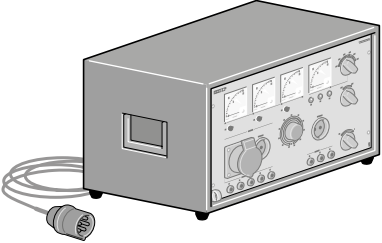
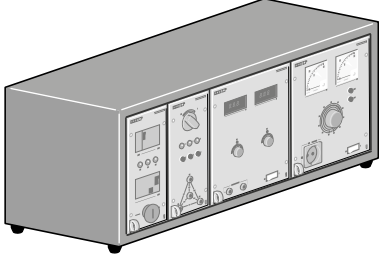
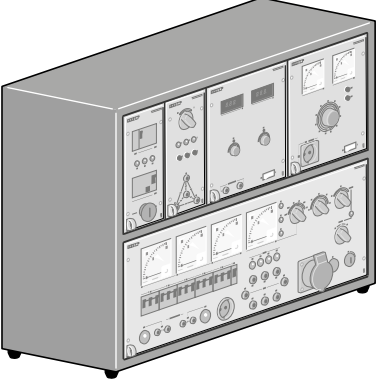

Housings made of steel plating are powder-coated in light grey and sometimes equipped with two fold-away side handles and four robust rubber feet. The rack-and-panel-type connector is mounted on the interior side of the perforated rear wall of the housing. Version complete with guide rails and 2 m connection cable with strain relief.

Technical data

Description			Order no.
Support housing		<p>Housing made of steel plating with space for 2WU with 2 carrying grips and 4 rubber feet Connection cable with Schuko plug W = 247 mm, D = 340 mm, H = 300 mm</p> <p>Connection cable with Cekon plug for 3-phase alternating current W = 247 mm, D = 340 mm, H = 300 mm</p>	<p>30-6A Z01</p> <p>30-6A Z03</p>
Support housing		<p>Housing made of steel plating with space for 4WU with 2 carrying grips and 4 rubber feet Connection cable with Schuko plug W = 483 mm, D = 340 mm, H = 300 mm</p> <p>Connection cable with Cekon plug for 3-phase alternating current W = 483 mm, D = 340 mm, H = 300 mm</p>	<p>30-6C Z01</p> <p>30-6C Z03</p>
Multiple housing		<p>Housing made of steel plating with space for 6WU, 4 rubber feet Connection cable with Schuko plug W = 755 mm, D = 315 mm, H = 320 mm</p> <p>Connection cable with Cekon plug for 3-phase alternating current W = 755 mm, D = 315 mm, H = 320 mm</p>	<p>30-5A Z01</p> <p>30-5A Z03</p>
Multiple housing		<p>Housing made of steel plating with space for 2 x 6WU, 4 rubber feet Connection cable with Schuko plug W = 755 mm, D = 315 mm, H = 320 mm</p> <p>Connection cable with Cekon plug for 3-phase alternating current W = 755 mm, D = 315 mm, H = 320 mm</p>	<p>30-5B Z01</p> <p>30-5B Z03</p>

Connecting leads & accessories

Technical data

Description		Order no.	
Set 1 of connecting leads		Set of connecting leads, consisting of 18 leads with safety plug, incl. line holder. 2 leads 50 cm black 2 leads 50 cm red 2 leads 50 cm blue 2 leads 100 cm black 2 leads 100 cm red 2 leads 100 cm blue 2 leads 150 cm black 2 leads 150 cm red 2 leads 150 cm blue Line Holder W = 207 mm, H = 61 mm - for installation on the vertical profile, made of aluminium plate. 13 suspension options for storing cable of various thicknesses - inclusive accessories for mounting on height extenders (Spring nuts M5 for small T-slots, ref.no. 78-2H and necessary screws, washers etc.)	83-5J X01
		As Set 1 but without line holder	83-5J
Set 2 of connecting leads		Set of connecting leads, consisting of 30 leads with safety plug, incl. line holder 2 leads 50 cm black 2 leads 50 cm blue 2 leads 50 cm yellow-green 2 leads 100 cm black 2 leads 100 cm blue 2 leads 100 cm yellow-green 2 leads 150 cm black 2 leads 150 cm blue 2 leads 150 cm yellow-green	83-5K X01
		As Set 2 but without line holder	83-5K
Set 3 of connecting leads		Set of connecting leads, consisting of 13 leads with safety plug, incl. line holder. 2 leads 50 cm black 2 leads 50 cm red 2 leads 100 cm black 2 leads 100 cm red 3 leads 150 cm black 1 leads 150 cm blue 1 leads 150 cm yellow-green	83-5L X01
		As Set 3 but without line holder	83-5L
Connecting leads / Test prods Safety crocodile clips /Test clips		Set connecting parts connecting leads, clip on test prods/ crocodile clips etc. consisting of: 2 connecting leads 100 cm, max. 15 A 2 clip on safety test prods, stainless steel, springy 2 clip on safety crocodile clips with fine wire section, max. 300 V 2 clip on safety test prod with insulated claws, max. 1 A 2 clip on safety test prod with hook clamp, max. 3 A	83-5M

System 3HU Training



Tablet of contents









G4.1 Fuse and protection modules	383
G4.2 AC Power supply 1-/ 3- phase, fixed	387
G4.3 AC Power supply, adjustable	391
G4.4 DC Power supply, fixed	393
G4.5 DC Power supply, adjustable	395
G4.6 Measuring and signaling devices	399
G4.7 Pneumatics	403
G4.8 Interfaces	405
G4.9 Soldering equipment	409
G4.10 Blank panels	413

G4







Fuse and protection modules

G4.1









Technical data

Description		Order no.
<p>Earth-leakage circuit breaker Alternating current, Type A</p> 		<p>Insert panel 18HP, Shock-proof protection system</p> <p>1/N/PE~ 50Hz 230 V 16 A</p> <p>Equipment: 1x 2-pole GFCI, type A, nominal current 25 A, nominal residual current 30 mA.</p> <p>W = 91,4 mm, H = 128,5 mm</p>
<p>Earth-leakage circuit breaker Alternating current, Type B</p> 		<p>Insert panel 24HP, Shock-proof protection system</p> <p>1/N/PE~ 50Hz 230 V 16 A</p> <p>Equipment: 1 2-pole GFCI, type B, sensitive to all currents for flat DC residual currents 30 mA, nominal current 25 A, wired to clamps.</p> <p>W = 121,9 mm, H = 128,5 mm</p>
<p>Earth-leakage circuit breaker 3-phase current, Type A</p> 		<p>Insert panel 24HP, Shock-proof protection system</p> <p>3/N/PE~ 50Hz 400 V 16 A</p> <p>Equipment: 1 earth leakage circuit breaker 25 A, 4 pole, type A, rated leakage current 30 mA</p> <p>W = 121,9 mm, H = 128,5 mm</p>
<p>Earth-leakage circuit breaker 3-phase current, Type B</p> 		<p>Insert panel 24HP, Shock-proof protection system</p> <p>3/N/PE~ 50Hz 400 V 16 A</p> <p>Equipment: 1 earth leakage circuit breaker 25 A, 4 pole, type B, sensitive to all currents for flat DC residual currents 30 mA</p> <p>W = 121,9 mm, H = 128,5 mm</p>

Technical data

Description		Order no.	
<p>Fuse and switch unit</p> 		<p>Insert panel 36HP Fuse and switch unit single-phase with key-operated button to release two circuits Position I "Group I" Position II "Group II" 1/N/PE~50 Hz 230 V 16 A</p> <p>E q u i p m e n t :</p> <ul style="list-style-type: none"> 1 circuit breaker single-pole C 16 A 1 key-operated button I/0/II, black 1 Off button 2 protectors 1 exterior control indicator lamp 1 signal lamp "Group I" 1 signal lamp "Group II" <p>including 2 wiring harness</p> <p>W = 182.9 mm, H = 128.5 mm</p>	<p>A3-0V</p>
<p>Fuse and switch unit</p> 		<p>Insert panel 36HP, Fuse and switch unit single-phase with key-operated button to release two circuits Position I "Group I" Position II "Group II" 3/N/PE~50 Hz 400 V 16 A</p> <p>E q u i p m e n t :</p> <ul style="list-style-type: none"> 1 circuit breaker single-pole C 16 A 1 key-operated button I/0/II, black 1 Off button 2 protectors 3 exterior control indicator lamps 1 signal lamp Group I 1 signal lamp Group II <p>including 2 wiring harness</p> <p>W = 182.9 mm, H = 128.5 mm</p>	<p>A3-0W</p>
<p>Fuse and switch unit</p>  		<p>Insert panel 36HP+12HP, Fuse- and switch-unit, single-phase release of voltages by integrated Ethernet module. Position Group I „green“ Position Group II „yellow“ 1/N/PE~ 50Hz 230 V 16 A</p> <p>E q u i p m e n t :</p> <ul style="list-style-type: none"> 1 circuit breaker single-pole C 16 A 1 key-operated button I/0/II, black 1 Off button 2 protectors 3 exterior control indicator lamps 1 signal lamp "experimental equipment is released" 1 signal lamp Group I 1 signal lamp Group II <p>includinf Ethernet-Interface</p>	<p>A3-0R</p>

Technical data

Description			Order no.
<p>Fuse and switch unit</p>  		<p>Insert panel 36HP + 12HP, Fuse and switch unit three-phase with key-operated button to release two current circuits via Ethernet nodes or via key-operated button. Release I "low voltage" Release II "line current"</p> <p>E q u i p m e n t :</p> <ul style="list-style-type: none"> 1 circuit breaker 3-pole C 16 A, 2 protectors, 3 relays, 3 exterior control indicator lamps, 1 signal lamp "Group I", 1 signal lamp "Group II" 1 Interface for Software control via Ethernet (Software not included) <p>Incl. second power cable harness.</p> <p>W = 182.9 mm, H = 128.5 mm</p> <p>Delivery will be including on blank panel A3-9D.</p>	<p>A3-0S</p>
<p>Fuse and switch unit</p>  		<p>Insert panel 48HP + 12HP, Fuse and switch unit 3-phase, Release of voltages via Ethernet nodes Position Group I „green" Position Group II „yellow" Position Group III „red" 3/N/PE~ 50Hz 400 V 16 A Equipment:</p> <ul style="list-style-type: none"> 1 Circuit breaker 3 pole C 16 A 1 Key-operated switch I/O/II, black 1 Key switch button I/O, black (Group III) 1 Off-button red 3 Contactors 3 External conductor indicator lamps 1 Signal lamp "Group I" 1 Signal lamp "Group II" 1 Signal lamp "Group II" <p>Including 2. and 3. Power cable harness</p> <p>Including Ethernet-Interface</p>	<p>A3-0T</p>
<p>Emergency off switch</p> 		<p>Insert panel 3HU / 12 HP Emergency off switch for the training area</p> <p>E q u i p m e n t :</p> <ul style="list-style-type: none"> 1 Emergency off switch with detent and yellow signal ring with 1 break contact and 1 shutter contact. <p>see A3-1A but with key-emergency off</p>	<p>A3-1A A3-1B</p>



AC Power supply 1-/ 3- phase, fixed







G4.2

Technical data

Description		Order no.	
<p>Laboratory safety socket</p> 		<p>Insert panel 12HP, Mains supply, 1/N/PE ~ 50Hz Equipment 3 Safety lab terminals (L1, N, PE) Optional power switch available</p> <p>W = 60,4 mm, H = 128,5 mm</p>	<p>A3-1W</p>
<p>Floating alternating current voltage</p> 		<p>Insert panel 36HP Alternating current voltage floating 230 V/110 VA Equipment: 1 Illuminated rocker switch, 1 thermic-magnetic equipment-overload switch 1 transformer with separated coils 1 socket without ground contact</p> <p>W = 182,9 mm, H = 196 mm</p>	<p>A3-2B</p>
<p>Floating alternating current voltage</p> 		<p>Cassette 36HP, Alternating current voltage floating 230 V/230 VA and mains supply 1/N/PE~ 50Hz 230 V 16 A Equipment: 2 Schuko sockets 1 Illuminated rocker switch 1 transformer with separated coils 1 Thermic-magnetic circuit breaker TMT1A 1 Rocker Switch 1 Shock-proof socket (for floating voltage) 2 Safety lab terminals</p> <p>W = 182,9 mm, H = 196 mm</p>	<p>A3-2C</p>
<p>Schuko sockets</p> 		<p>Insert panel 24HP, Equipment: 4 Schuko sockets Optional power switch available</p> <p>W = 121,9 mm, H = 128,5 mm</p>	<p>A3-1L</p>
		<p>As A3-1L but with green marking</p>	<p>A3-1L Z001</p>
<p>Schuko sockets</p> 		<p>Insert panel 12HP, Equipment: 2 Schuko sockets</p> <p>W = 60,9 mm, H = 128,5 mm</p>	<p>A3-1J</p>
		<p>As A3-1J but with green marking</p>	<p>A3-1J Z001</p>







AC- Power supply 1 / 3- phase, fixed

Technical data

Description		Order no.	
<p>Low voltages Alternating current floating</p>		<p>Eurocassette 24HP AC low voltage floating output with green strip at the lower edge to indicate low voltage 6, 12, 18, 24, 30, 36, 42 V/3 A and rectifier</p> <p>W = 121,9 mm, D = 196 mm, H = 128,5 mm</p>	A3-3B
<p>Low voltages Alternating current floating</p> <p></p>		<p>Insert panel 36HP, Low AC voltage, floating 2, 4, 6, 8, 10, 12 V / 10 A Equipment: 1 illuminated rocker switch 3 thermic- magnetic circuit breakers 4 safety lab terminals</p> <p>W = 182,9 mm, H = 128,5 mm</p>	A3-2D
<p>Laboratory safety socket</p> <p></p>		<p>Insert panel 12HP, Mains voltage 3ph AC 50Hz 230 / 400 V 16 A to safety lab terminals. Equipment: 5 Safety lab terminals (L1, L2, L3, N, PE) Optional power switch available</p> <p>W = 60,4 mm, H = 128,5 mm</p>	A3-1X
<p>CEE Socket</p> <p></p>		<p>Insert panel 24HP, Mains supply 3/N/PE~ 50Hz 230 / 400 V 16 A an 1 CEEE-Socket</p> <p>Optional power switch available</p> <p>W = 121,6 mm, H = 128,5 mm</p>	A3-1T

AC- Power supply 3- phase, fixed



Technical data

Description		Order no.	
<p>CEE Socket 5- pin</p> 		<p>Insert panel 24HP Mains supply 3/N/PE ~ 50 Hz 230 / 400 V 16 A Equipment: 1 CEE-Socket 5p400 V16 A 5 Safety lab terminals (L1, L2, L3, N, PE)</p> <p>W = 121,6 mm, H = 128,5 mm</p>	A3-1U
<p>CEE Socket</p> 		<p>Insert panel 24HP Mains supply 3/N/PE~50Hz 400 V 32A to CEE Socket Equipment: 1 CEE-Socket 5p400 V/32A (red) wired to terminal strip</p> <p>W = 121,9 mm, H = 128,5 mm</p>	A3-1V
<p>Low voltages Three-phase current, floating</p> 		<p>Insert panel 60HP, Three-phase current power supply AC 3~10/17, 3V 5A, floating Equipment: 1 Rotary switch I/O, 3 Incandescent bulbs 1 Three-phase current transformer with fine wire fuse 3 Thermic-magnetic circuit breakers TMT5A 4 Safety lab terminals</p> <p>W = 304,8 mm, H = 128,5 mm</p>	A3-2E

AC Power supply, adjustable

G4.3



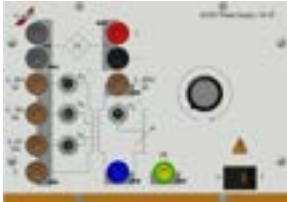



Technical data

Description		Order no.	
DC/AC voltage		<p>Eurocassette 52 HP, AC- and DC voltage floating, 0...260 V eff/ 3A (AC/DC) or 0...50 V eff / 10 A (AC/DC) with analog display instruments Residual ripple at DC ca. 48%</p> <p>W = 264,2 mm, D = 196 mm, H = 128,5 mm</p>	A3-3P
Smart AC-constant floating		<p>Eurocassette 66 HP, AC-Constant with floating AC/Voltage 2...260 V / 2A electromechanical stabilization by following controller and setpoint decoder</p> <p>Two lighted LCD-Display Display of voltage, current und power. 4 programmable Voltage value. Output limitation, password-protected</p> <p>Including Ethernet and USB Interface.</p> <p>W = 335,2 mm, D = 196 mm, H = 128,5 mm</p>	A3-2S
DC/AC voltage		<p>Eurocassette 36 HP, AC 0..260 V / 2A not floating Small AC floating 0..6 V / 15 A, 0..18 V / 16 A und 0..42 V / 3A Separate bridge rectifier (B2)</p> <p>W = 182,9 mm, D = 196 mm, H = 128,5 mm</p>	A3-3F

DC Power supply, fixed

G4.4





Technical data

Description		Order no.	
<p>Switching power supply 5 V / 5 A</p> 		<p>Insert panel 24HP , Switching power supply with clocked output voltage 5 V / 5 A, Outputs on 2 Safety lab terminals Specifications: Output power: 25 W Residual ripple: 80 mVp-p Voltage tolerance: $\pm 2.0\%$ Line regulation: $\pm 0,5\%$ Line regulation: $\pm 1.0\%$ Overload protection. Hiccup mode</p> <p>W= 121,9 mm, H = 128,5 mm</p>	A3-4M
<p>Switching power supply +/- 15 V / 2 A</p> 		<p>Insert panel 24HP , Switching power supply with clocked output voltage ± 15 V / 2 A, Outputs on 3 safety lab terminals Specifications: Output power: 2 x 30 W Residual ripple: 120 mVp-p Voltage tolerance: $\pm 1.0\%$ Line regulation: $\pm 0,5\%$ Line regulation: $\pm 0,5\%$ Overloaded protection. Hiccup mode</p> <p>W = 121,9 mm, H 128,5 mm</p>	A3-4N
<p>Switching power supply 24 V / 6 A</p> 		<p>Insert panel 24HP , Switching power supply with clocked output voltage 24 V / 6 A, Specifications: Output power: 150 W Residual ripple: 150 mVp-p Voltage tolerance: $\pm 1.0\%$ Line regulation: $\pm 0,5\%$ Line regulation: $\pm 0,5\%$ Overloaded protection</p> <p>W = 121 mm, H = 128,5 mm</p>	A3-4P
		<p>as A3-4P but for mounting into aluminium channel 42 HP</p> <p>W = 213,1 mm, H = 128,5 mm</p>	A3-4X

DC Power supply, adjustable







G4.5

Technical data

Description		Order no.	
<p>Smart DC- stabilizer 2 x 0..30 V / 2 x 0..2A</p> 		<p>Eurocassette 42HP, Multifunctional laboratory power device 2- Channelig with two backlit LCD displays Voltage and current limit can be continuously adjusted by means of rotary encoder pulses .</p> <p>Function types :</p> <ul style="list-style-type: none"> - Series operation (0..60 V // 0..2 A) - Parallel operation (0..30 V / 0-4 A) - Master- Slave- Operation - Tracking mode (+30 V..0 ..- 30 V) <p>The output parameters can be limited locally or by the Elution software . Via the optional Elution software current and voltage waveforms and ramps function (sine , triangle , square , pulse , PWM) can be programmed. W = 213,3 mm,D = 196 mm, H = 128,5 mm</p> <p>For more details see chapter DC Power Supply adjustable 3HU</p>	<p>A3-5S</p>
<p>Smart DC- stabilizer 2 x 0..30 V / 2 x 0..2A</p> 		<p>Eurocassette 42HP , Multifunctional laboratory power device 2- Channeling with touch panel. Voltage and cur- rent limit can be adjusted continuously .</p> <p>Function types :</p> <ul style="list-style-type: none"> - Series operation (0..60 V // 0..2 A) - Parallel operation (0..30 V / 0-4 A) - Master- Slave- Operation - Tracking mode (+30 V..0 ..- 30 V) <p>The output parameters can be limited locally or by the elution software. Via the built-in touch screen current and voltage waveforms and ramps function (sine , triangle , square , pulse , PWM) can be programmed.</p> <p>W = 213,3 mm, D = 196 mm, H = 128,5 mm</p> <p>For more details see chapter DC Power Supply adjustable 3HU</p>	<p>A3-5T</p>

DC- Power supply, adjustable

Technical data

Description	Order no.
<p>Adjustable DC- stabilizer</p>  	 <p>Insert panel 84 HP DC stabilizer 2 x 0...30 V/0...2 A Digital displays selectable V/A. Preset for voltage- and current limit</p> <p>The devices can be operated in series or parallel connection . W = 426,7mm, H = 128,5 mm</p> <p>option interface Insert panel for System 3HU incl . 2m patch cable Interface Type : Ethernet Are the Interface Connections be on the rear panel</p> <p>A3-5P</p> <p>N3-4Q Z102</p>
<p>Adjustable DC- stabilizer</p>  	 <p>Insert panel 76HP DC stabilizer 0...30 V/0...2 A Digital display V/A selectable and 10 turn potentiometer Preset for voltage- and current limit</p> <p>W = 386,1 mm, H = 128,5 mm</p> <p>Option Interface Insert panel for an System 3HU incl. 2m patch cable Interface Type : Ethernet The Interface Connections are on the rear panel</p> <p>A3-5H</p> <p>N3-4P Z102</p>

G Electronics







System 3HU Training







Measuring and signaling devices

G4.6





Technical data

Description		Order no.	
<p>Continuity testers</p>		<p>Eurocassette 12HP Continuity tester electronically (acoustic)</p> <p>W = 60,9 mm, D = 196 mm, H = 128,5 mm</p>	<p>A3-6D</p>
<p>Smart multimeter</p>  		<p>Insert panel 24HP, Digital multimeter with 5 1/2 digits manual range selection Technical data :</p> <p>DC voltage Ranges 200 mV, 2V ,20 V , 200 V , 1000 V ,2000 V AC Voltage (RMS) Ranges 200 mV, 2V , 20 V , 200 V , 750 V , 2000 V Overload protection up to max . 1000 V DC Current Ranges 200 µA, 2 mA ,20 mA , 200 mA , 2 A , 20 A AC Current (RMS) Ranges 200 µA , 2 mA , 20 mA , 200 mA , 2 A , 20A resistors Ranges 200 ohms , 2 kOhm , 20 kOhm , 200 kOhm , 2000 KOhm , 20 MOhm Measurement temperature-10 ... 250 ° C Fequenzmessung : up to 50 kHz</p> <p>Interface Option:</p> <p>Ethernet including 2 m patch cable</p> <p>Accessories : Test leads / probes / alligator clips etc.</p>	<p>A3-6N</p> <p>N3-4P Z102</p> <p>83-5M</p>

Technical data

Description		Order no.	
<p>Function generator</p> 		<p>Insert panel 36HP, Function generator 0.2 Hz ... 2 MHz Technical data : Power : 230 V \pm 10 % / 49-61 Hz . The adjustment of the frequency is carried out by Potentiometer with scale and Redary switch in six decadal Ranges . Frequenzcy range : 20/200 Hz , 2/20/200 kHz , 2 MHz Waveforms : sine ,triangle , square Harmonic distortion of sine : < 1.5 % up to 100 kHz , < 5 % to 2 MHz Output amplitude: U_{ss} : max . 20 V at idle Type 10 V into 50 ohms The output is no-load and short circuit protection , -20dB Attenuation via BNC connector socket . DC offset can be activated : 0 to \pm 10 V adjustable External sweep : VCO module ation input 0 ... 5 V for the frequency change of 100: 1 Input impedance about 17 ohm W = 182,9 mm, H = 128,5 mm</p>	<p>A3-6V</p>
<p>Smart function generator</p> 		<p>Eurocassette 42HP Function generator with frequency and Event counter , touch display and Ethernet and USB interface . Frequency range 0.01 Hz ... 20 MHz Waveforms : sine , square , triangle , pulsee , DC</p> <ul style="list-style-type: none"> - Modes of operation: <ul style="list-style-type: none"> continuous Frequency sweep (sweep) amplitude ramp Puls width modulation - Trigger / Module ation internal or external - Frequency Counter - Event counter - Power output with on / off function - Display off function DC <p>Technical specifications: Sine, square : 0.01 Hz ... 20 MHz Triangle, pulse : 0.01 Hz ... 1 MHz Amplitude : 1mV ... 20 V_{pp} (idle) DC Offset : \pm 10 V (idle) external Trigger : 0 ... 5 V Counting : 0.1Hz to 30 MHz ... Input Voltage : 0.5V ... 100 V_{eff} B = 213,3 mm, D = 196 mm, H = 128,5 mm</p>	<p>A3-6T</p>





Technical data

Description		Order no.	
<p>Oscilloscope</p> 		<p>Insert panel 52 HP, 2 - channel PC Oscilloscope with Ethernet interface . The PC digital oscilloscope is simple to use and is completely included in the operated software. Technical data : Bandwidth: 150 MHz Channels: 2 channels , Class 1 , common ground Vertical : 2.5 mV / div - 100 V / div , up to 250 V / div with Y strain Timebases 35 ranges of 1 ns / div to 200 s / div Trigger : auto , triggered , single shot , Trigger source : CH1, CH2 , EXT , net. Type : cross , Pulsebreite or Delay Power supply : 100 - 230 V / AC 47 - 63 Hz Optional : Differential Voltage Probes W = 264,2 mm, D = 210 mm, H = 128,5 mm</p>	<p>A3-6Q Z102</p>
<p>Oscilloscope</p> 		<p>Insert panel 52 HP , 4- Channel PC Oscilloscope with Ethernet interface . The PC digital oscilloscope is simple to use and is completely on the included software operated . Technical data : Bandwidth: 150 MHz Channels: 4 channels , Class 1 , common ground Vertical : 2.5 mV / div- 100 V / div , up to 250 V / div with Y strain Timebases 35 ranges of 1 ns / div to 200 s / div Trigger : auto , triggered , single shot Trigger source : CH1, CH2 ,CH3,CH4 , EXT , net. Type : cross , Pulse width or Delay Power supply : 100- 230 V / AC 47- 63 Hz Optionally available : Differential voltage probes W = 264,2 mm, D = 210 mm, H 128,5 mm</p>	<p>A3-6R Z102</p>

Pneumatics

G4.7

Technical data

Description		Order no.	
<p>Compressed air supply</p> 		<p>Insert panel 6HP, Compressed air supply 6HP 1 Quick coupling NW 5 1/8" Including 1 Quick connectors NW 5 plastic hose 6/4</p> <p>W = 30,2 mm, H = 128,5 mm</p>	<p>A3-8R</p>
<p>Compressed air supply</p> 		<p>Insert panel 36HP, Compressed air supply 0.5 ... 10 bar Equipment: 1 pressure reducing valve 1 manometer 0 ... 10 bar , cl. 2,5 1 one-hand quick release NW 2.5 decreasing -unrelieved compressed air max . 12 bar -adjusted compressed air 0 ... 10 bar 1 one-hand quick release NW 2.5 1 Quick connectors NW 2,5 W = 30,2 mm, H = 128,5 mm</p>	<p>A3-8S</p>



Interfaces

G4.8

Technical data

Description			Order no.
<p>Interface field LPT 25-pole</p> 		<p>Power supply strip 6HP , Interface field LPT parallel . Equipment: 1 Sub-D connector 25 - pole female with 3 m connection cable and mating connector W = 30,2 mm, H = 128,5 mm</p>	A3-7A
<p>Interface field COM/RS232 25-pole</p> 		<p>Power supply strip 6HP , Interface Field COM / RS232 serial . Equipment: 1 Sub-D connector 25 - pole male with 3 m connection cable and mating connector . W = 30,2 mm, H = 128,5 mm</p>	A3-7B
<p>Interface field COM/RS232 9-pole</p> 		<p>Power supply strip 6HP , Interface field COM / RS 232 serial . Equipment: 1 Sub-D connector 9 - pole male with 3 m connection cable and mating connector . W = 30,2 mm, H = 128,5 mm</p>	A3-7C
<p>Interface field VGA 15-pole</p> 		<p>Power supply strip 6HP , Interface field VGA . Equipment: 1 Sub-D connector 15 - pole HD male with 3 m connection cable and mating connector . W = 30,2 mm, H = 128,5 mm</p>	A3-7D

Technical data

Description		Order no.	
<p>Interface field DVI-I</p> 		<p>Power supply strip 6HP , Interface box DVI-I .</p> <p>Equipment: 1 DVI-I connectors female with about 3 m connection cable and mating connector</p> <p>W = 30,2 mm, H = 128,5 mm</p>	A3-7E
<p>Interface field USB</p> 		<p>Power supply strip 6HP , Interface field USB .</p> <p>Equipment: 2 USB Connector Type A female with about 3 m connection cable and mating connector</p> <p>W = 30,2 mm, H = 128,5 mm</p>	A3-7F
<p>Interface field PS/2</p> 		<p>Power supply strip 6HP , Interface field PS / 2.</p> <p>Equipment: 2 PS / 2 mini DIN 6- pole connector female with 3 m connection cable and Mating connector .</p> <p>W = 30,2 mm, H = 128,5 mm</p>	A3-7G
<p>Interface field Audio L-R</p> 		<p>Power supply strip 6HP, Interface field Audio L - Audio R.</p> <p>Equipment: 2 RCA connectors red and white female with about 2.5 m connection cable and mating connector.</p> <p>W = 30,2 mm, H = 128,5 mm</p>	A3-7H
<p>Interface field Audio</p> 		<p>Power supply strip 6HP, BNC interface.</p> <p>Equipment: 2 BNC Connector mounting sockets 50 Ohm, pluggable on both sides.</p> <p>W = 30,2 mm, H = 128,5 mm</p>	A3-7J
<p>Interfac field FireWire</p> 		<p>Power supply strip 6HP, Interface FireWire field.</p> <p>Equipment: 1 IEEE 1394 connector 6-pole with 3 m connection cable and mating connector.</p> <p>W = 30,2 mm, H = 128,5 mm</p>	A3-7K

Technical data

Description		Order no.
Interface field Network socket 		Power supply strip 6HP, Interface field RJ45 network socket. Equipment: 1 RJ45 connector socket 8-pole Cat6 pluggable on both sides W = 30.2 mm, H = 128.5 mm as A3-7L but with 2 x RJ45 A3-7L A3-7L Z007
Interface field S-VHS 		Power supply strip 6HP, Interface box S-VHS. Equipment: 1 PS / 2 mini-DIN 4-pole connector female with 2 m connection cable and mating connector W = 30,2 mm, H = 128,5 mm A3-7M
Interface field IEEE-488/GPIB 		Power supply strip 6HP, Interface Field IEEE-488 / GPIB. Equipment: 1 IEEE-488 Centronics 24-pole female with 2 m connection cable and mating connector W = 30,2 mm, H = 128,5 mm A3-7N
Power supply strip 		Power supply strip 6HP, BNC interface. Equipment: 2 BNC Connector mounting sockets 50 Ohm, pluggable on both sides W = 30,2 mm, H = 128,5 mm A3-7P
Potential equalization 		Insert panel 6HP 1 connector for potential equalization POAG-ID6 (counterpart customer) >> unwired W = 30,2 mm, H = 128,5 mm A3-7V
Election pole 		Insert panel 18 HP, 9 Safety lab terminals as an option Pole, 6 Connector sockets labeled with 1 ... 6, 3 Connector sockets labeled with A, B, C, 2 BNC Connector mounting sockets 50 ohms. Completely unwired. W = 91,4 mm, H = 128,5 mm A3-1D





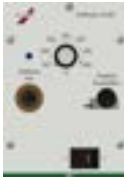

Soldering equipment

G4.9

Technical data

Description			Order no.
Soldering station		<p>Eurocassette 18 HP Soldering station 80 W temperature controlled with soldering iron and soldering iron stand</p> <p>W = 91,4 mm, D = 196 mm, H = 128,5 mm</p>	A3-8A
Soldering station		<p>Eurocassette 18 HP Soldering station Analog 80 W brand WELLER WS 81 Analog electronic control for soldering tools up to 80 W Temperature range 150 ° C- 450 ° C Temperature control by rotary</p> <p>With supplied accessories: 1 80 W Silver Line soldering iron WSP 80 1 soldering tip LT B 1 Safety WPH 80</p> <p>W = 91,4 mm, D = 196 mm, H = 128,5 mm</p>	A3-8H

Technical data

Description		Order no.	
<p>Soldering station</p> 		<p>Insert panel 36HP Temperature controlled soldering station Manufacturer Ersa ANALOG 80 Temperature in the range of 150 ° C to 450 C adjustable potentiometer control by analog electronic.</p> <p>Included accessories: 1 soldering iron basic tool 810 CDJ with tip 0832 CD 1 tray stand OA 41 W = 182,9 mm, H = 128,5 mm</p>	A3-8F
<p>Soldering station</p> 		<p>Insert panel 36HP temperature controlled soldering station WS 81 manufacturer Weller. Temperature in the range of 150 ° C to 450 ° C adjustable potentiometer control by analog electronic with automatic tool recognition to 80 W.</p> <p>Included accessories: 1 soldering iron WSP 80 with soldering tip LT B 1 Safety rest WPH 80 W = 182,9 mm, H = 128,5 mm</p>	A3-8G
<p>Soldering- /desoldering station</p> 		<p>Eurocassette 36HP Multifunctional Power soldering and desoldering station consisting of:</p> <ul style="list-style-type: none"> - Ersa Soldering station digital 2000 A with power tool soldering iron 24 V / 80 W and workstand OA 42 - Ersa DIGITAL 2000 A desoldering with Vacuum unit with desoldering device X tool 24 V / 2x60 W and soldering iron stand OA 44th <p>W = 182,9 mm, H = 196 mm, D = 128,5 mm</p>	A3-8M Z601

G Electronics



System 3HU Training

Blank panels

G4.10

Technical data

Description		Order no.
Blank panel 4HP		Blank panel 4HP / 3HU W = 20,3 mm, H = 128,5 mm A3-9A
Blank panel 6HP		Blank panel 6HP / 3HU W = 30,4 mm, H = 128,5 mm A3-9B
Blank panel 8HP		Blank panel 8HP / 3HU W = 40,5 mm, H = 128,5 mm A3-9C
Blank panel 12HP		Blank panel 12HP / 3HU W = 60,9 mm, H = 128,5 mm A3-9D
Blank panel 18HP		Blank panel 18HP / 3HU W = 91,4 mm, H = 128,5 mm A3-9E
Blank panel 24HP		Blank panel 24HP / 3HU W = 121,9 mm, H = 128,5 mm A3-9F
Blank panel 36HP		Blank panel 36HP / 3HU W = 182,9 mm, H = 128,5 mm A3-9G

Technical data

Description			Order no.
Blank panel 42HP		Blank panel 42HP / 3HU W = 213,3 mm, H = 128,5 mm	A3-9H
Blank panel 48HP		Blank panel 48HP / 3HU W = 243,8 mm, H = 128,5 mm	A3-9J
Blank panel 60HP		Blank panel 60HP / 3HU W = 304,8 mm, H = 128,5 mm	A3-9K
Blank panel 96HP		Blank panel 96HP / 3HU W = 487,6 mm, H = 128,5 mm	A3-9L
Blank panel 24HP with description		Blank panel 24HP / 3HU W = 121,9 mm, H = 128,5 mm	A3-9R

H Accessories ESD



ESD Accessories

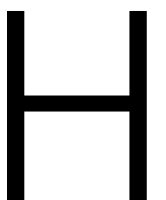





Technical data

Description		Order-No.
<p>ESD Monitor for monitoring works at EPA workplaces, conform to standards</p> <p>W = 80 mm, H = 480mm</p> <p>Primus One Types 1 / N / PE Insert panel traffic red 1 / N / PE Insert panel signal blue 1 / N / PE Insert panel black grey 3 / N / PE Insert panel traffic red 3 / N / PE Insert panel signal blue 3 / N / PE Insert panel black grey</p> <p>3 HU Insert panel 1 / N / PE Insert panel lightgrey 42HP 3 / N / PE Insert panel lightgrey 52HP</p>		<p>K5-1E00DE.480.3020 K5-1E00DE.480.5008 K5-1E00DE.480.7021 K5-1F00DE.480.3020 K5-1F00DE.480.5008 K5-1F00DE.480.7021</p> <p>42-0X.3 42-0Y.3</p>
<p>Earthing armband with snap-fit fastener</p>		<p>01-41 X01</p>
<p>Connecting cable 2,4 m, with snap-fit fastener</p>		<p>01-41 X02</p>
<p>Earthing module EBP with Schuko / DK10</p> <p>with 3 pushbutton connections with 10 mm diameter, each with protective resistor 1 MOhm.</p>		<p>01-41 X03</p>



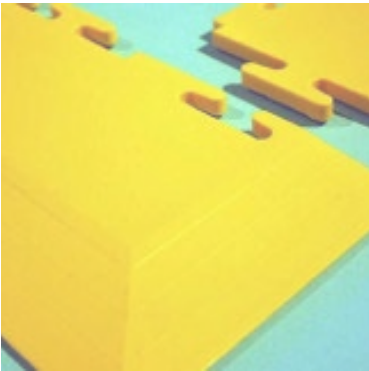

Technical data

Description		Order-No.
<p>Earthing module EBP</p> <p>with 3 pushbutton connections with 10 mm diameter, each with protective resistor 1 MOhm, yellow, without cable</p>		01-41 X04
<p>Earthing module EBP</p> <p>with 3 pushbutton connections with 10 mm diameter, each with protective resistor 1 MOhm. Cable 3m M4 eyelet</p>		01-41 X05
<p>Earthing module EBP</p> <p>with 3 pushbutton connections with 10 mm diameter, each with protective resistor 1 MOhm, for fixing on the side of the table. Cable 3m, M4 eyelet</p>		01-41 X06
<p>ESD earthing cable</p> <p>for table and floor mat Socket DK10 / M5 eyelet Length: 4,50 m, 1 MOhm Flattened plug prevents tripping over the connection point</p>		01-42 X01
<p>Earthing Snap fastener Universal Kit</p> <p>consisting of:</p> <p>snap fastener ball-part 10 mm snap fastener spring-part 10 mm screw, washer, EPA-bonding label, screw base</p>		01-42 X02

Technical data

Description		Order-No.
<p>Central Earthing box</p> <p>Terminal strip for max 7 earthing cables with eyelet M4.</p>		01-42 X03
<p>Conductive table mat</p> <p>Table mat, electrically conductive W = 1000 mm, D = 600 mm, H = 2.0 mm</p> <p>colour grey discharge resistor 107-108 Ohm, use loose or gled, 2 x connection DK 10 at side</p>		01-42 X04
<p>Electrically conductive floor mat</p> <p>with a rubber upper surface and a permanently conductive backing. Size 1500 mm x 1220 mm Inclusive connecting cable 4.5 m, 1 Ohm</p> <p>colour grey Flattned plug prevents tripping over the connection point.</p>		01-43 X01
<p>Earthing protect floor tile</p> <p>500 mm x 500 mm x 5 mm electrostatically discharging, Colour: dark grey</p> <p>- surface resistance: $2,2 \times 10^4 \Omega$ to $3 \times 10^6 \Omega$ - discharge resistor: $2,9 \times 10^4 \Omega$ to $5,7 \times 10^5 \Omega$ Price per m² (consisting of 4 pcs)</p>		01-43 X02
<p>Earthing protect tile edge</p> <p>for floor tile Ecotile PVC 500 mm x 80 mm x 7 mm > 1 mm, structured colour yellow / no ESD-material</p> <p>colour dark grey / no ESD-material</p>		01-43 X03 01-43 X04

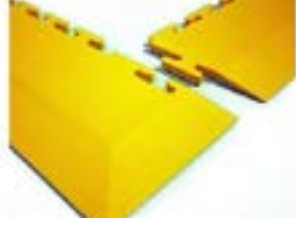
Technical data

Description		Order-No.
<p>Electrically conductive for grounding of floor tiles</p> <p>Colour black</p> <p>Width = 70 mm price per meter</p>		01-43 X09
<p>Earthing connection set for wall connection of floor coverings</p> <p>Grounding cable 3 m with eyelet</p>		01-43 X10
<p>ESD-Protect edge, yellow</p> <p>for floor tiles 580 mm x 80 mm x 7 mm >1 mm, structures no ESD material</p>		01-43 X11
<p>ESD-Protect edge, grey</p> <p>for floor tiles 580 mm x 80 mm x 7 mm >1 mm, structures no ESD material</p>		01-43 X12

Technical data

Description		Order-No.
<p>EPA-Barrier post</p> <p>barrier tube and foot: polished stainless steel conductive rubber ground plate Ribbon colour: yellow, resistance 10E9 Ohm double sided printing: "ESD PROTECTED AREA" height: 910 mm, 76 mm diameter groundplate: 350 mm weight: ca. 9,6 kg Ribbon length: 4 m (1 pcs)</p>		01-43 X08
<p>Emit Zero-Volt Ionisier</p> <p>Voltage offset controlled to ± 3 Volts typical. RS-485 communication for use with EMIT SIM Software. Compatible with EMIT SIM Software Features steady state DC ionization and EMIT's patented Sense Feedback balancing. Rapid Access Maintenance. Provides automatic balancing of the ionization system. Sealed „Thru-Tunnel“ air flow design. Communication via RS485 compatible data output with a host computer. Low Ozone Emissions - tests well below the OSHA limit of 0.05 ppm ozone.</p>		01-44 X01
<p>Shoe and wristband test station</p> <p>for wall mounting with contact to release entrance barriers including 2-pole shoe electrode and power supply</p>		01-44 X02
<p>ESD-MultiClean surface cleaner</p> <p>Special cleaner for static discharging and conductive surfaces. Protects the conductivity. Leaves no insulation residues. 1l - Spray bottle</p>		01-45 X01

Technical data

Description		Order-No.
<p>ESD-MultiClean surface cleaner</p> <p>Special cleaner for static discharging and conductive surfaces. Protects the conductivity. Leaves no insulation residues. 5 l - Canister</p>		<p>01-45 X02</p>
<p>ESD-MultiClean surface cleaner</p> <p>Special cleaner for static discharging and conductive surfaces. Protects the conductivity. Leaves no insulation residues. 10 l - Canister</p>		<p>01-45 X03</p>



I Chairs









Chairs



Chairs

Conference chair

Technical Data

Description			Order-no.
<p>Tec conference chair</p> <p>4-legged conference chair, stackable 4-fold.</p> <p>Seat upholstery, plastic backrest with upholstered pad, frame chromed with plastic glides for soft floors.</p> <p>Armrests optionally available.</p> <p>Seat-hight: 440 mm Seat-width: 450 mm Seat-depth: 460 mm Backrest height: 430 mm Backrest width: 460 mm</p>	 	<p>Upholstery without armrests</p> <p>anthracite</p> <p>black</p> <p>dark blue</p> <p>with armrests</p> <p>anthracite</p> <p>black</p> <p>dark blue</p> 	<p>S1-7A</p> <p>S1-7B</p> <p>S1-7C</p> <p>S1-7A X01</p> <p>S1-7B X01</p> <p>S1-7C X01</p>
<p>Tec cantilever conference chair</p> <p>Seat upholstery, plastic backrest with upholstered pad, frame chromed with plastic glides for soft floors.</p> <p>Armrests optionally available.</p> <p>Seat-hight: 440 mm Seat-width: 450 mm Seat-depth: 460 mm Backrest height: 430 mm Backrest width: 460 mm</p>	 	<p>Upholstery without armrests</p> <p>anthracite</p> <p>black</p> <p>dark blue</p> <p>with armrests</p> <p>anthracite</p> <p>black</p> <p>dark blue</p> 	<p>S1-9A</p> <p>S1-9B</p> <p>S1-9C</p> <p>S1-9A X01</p> <p>S1-9B X01</p> <p>S1-9C X01</p>

Chairs

Office swivel chair

Technical Data

Description			Order-no.
<p>Tec 4 Office swivel chair</p> <p>with plastic membrane backrest (58 cm), upholstered. 8 cm height adjustable. Mechanic with automatically customized body-weight. Seat tilt from -3° and 5,0 cm seat depth adjustment.</p> <p>Footbase design plastic black or aluminium polished.</p> <p>Armrests optionally available.</p> <p>Seat width: 490 mm Seat depth: 400-450 mm Backrest height: 580-660 mm</p> <p>Optionally available with armrests! cannot be retrofitted</p>		<p>Upholstery Castors</p> <p>Footbase plastic black</p> <p>anthracite hard, for carpeted floor black hard, for carpeted floor dark blue hard, for carpeted floor</p> <p>anthracite soft, for hard floor black soft, for hard floor dark blue soft, for hard floor</p> <p>Footbase aluminium polished</p> <p>anthracite hard, for carpeted floor black hard, for carpeted floor dark blue hard, for carpeted floor</p> <p>anthracite soft, for hard floor black soft, for hard floor dark blue soft, for hard floor</p> 	<p>S5-1A S5-1B S5-1C</p> <p>S5-1D S5-1E S5-1F</p> <p>S5-1A X01 S5-1B X01 S5-1C X01</p> <p>S5-1D X01 S5-1E X01 S5-1F X01</p>
<p>Tec 6 Office swivel chair</p> <p>with high backrest (63 cm), height adjustable 7 cm. T-armrests adjustable in height and width.</p> <p>Synchronous mechanism with 5-fold arrestable synchronous movement. Preselectable seat tilt (-1° or -5°) and 5 cm seat depth adjustment.</p> <p>Footbase design plastic black or aluminium polished.</p> <p>Seat width: 470 mm Seat depth: 390 - 440 mm Backrest height: 630 - 700 mm</p>		<p>Upholstery Castors</p> <p>Footbase plastic black</p> <p>anthracite hard, for carpeted floor black hard, for carpeted floor dark blue hard, for carpeted floor</p> <p>anthracite soft, for hard floor black soft, for hard floor dark blue soft, for hard floor</p> <p>Footbase aluminium polished</p> <p>anthracite hard, for carpeted floor black hard, for carpeted floor dark blue hard, for carpeted floor</p> <p>anthracite soft, for hard floor black soft, for hard floor dark blue soft, for hard floor</p> 	<p>S5-2A S5-2B S5-2C</p> <p>S5-2D S5-2E S5-2F</p> <p>S5-2A X01 S5-2B X01 S5-2C X01</p> <p>S5-2D X01 S5-2E X01 S5-2F X01</p>

Chairs

Office swivel chair

Technical Data

Description			Order-no.																														
<p>Tec 8 Office swivel chair</p> <p>with high mesh backrest (61 cm), height adjustable 7 cm. T-armrests adjustable in height and width.</p> <p>Synchronous mechanism with 5-fold arrestable synchronous movement.</p> <p>Preselectable seat tilt (-1° or -5°) and 5 cm seat depth adjustment.</p> <p>Footbase design plastic black or aluminium polished.</p> <p>Seat-width: 470 mm Seat-width: 390-440 mm Backrest-height: 610-680 mm</p>		<table border="0"> <tr> <td>Upholstery</td> <td>Castors</td> </tr> <tr> <td>Footbase plastic black</td> <td></td> </tr> <tr> <td>anthracite</td> <td>hard, for carpeted floor</td> </tr> <tr> <td>black</td> <td>hard, for carpeted floor</td> </tr> <tr> <td>dark blue</td> <td>hard, for carpeted floor</td> </tr> <tr> <td>anthracite</td> <td>soft, for hard floor</td> </tr> <tr> <td>black</td> <td>soft, for hard floor</td> </tr> <tr> <td>dark blue</td> <td>soft, for hard floor</td> </tr> <tr> <td>Footbase aluminium polished</td> <td></td> </tr> <tr> <td>anthracite</td> <td>hard, for carpeted floor</td> </tr> <tr> <td>black</td> <td>hard, for carpeted floor</td> </tr> <tr> <td>dark blue</td> <td>hard, for carpeted floor</td> </tr> <tr> <td>anthracite</td> <td>soft, for hard floor</td> </tr> <tr> <td>black</td> <td>soft, for hard floor</td> </tr> <tr> <td>dark blue</td> <td>soft, for hard floor</td> </tr> </table> 	Upholstery	Castors	Footbase plastic black		anthracite	hard, for carpeted floor	black	hard, for carpeted floor	dark blue	hard, for carpeted floor	anthracite	soft, for hard floor	black	soft, for hard floor	dark blue	soft, for hard floor	Footbase aluminium polished		anthracite	hard, for carpeted floor	black	hard, for carpeted floor	dark blue	hard, for carpeted floor	anthracite	soft, for hard floor	black	soft, for hard floor	dark blue	soft, for hard floor	<p>S5-3A S5-3B S5-3C S5-3D S5-3E S5-3F S5-3A X01 S5-3B X01 S5-3C X01 S5-3D X01 S5-3E X01 S5-3F X01</p>
Upholstery	Castors																																
Footbase plastic black																																	
anthracite	hard, for carpeted floor																																
black	hard, for carpeted floor																																
dark blue	hard, for carpeted floor																																
anthracite	soft, for hard floor																																
black	soft, for hard floor																																
dark blue	soft, for hard floor																																
Footbase aluminium polished																																	
anthracite	hard, for carpeted floor																																
black	hard, for carpeted floor																																
dark blue	hard, for carpeted floor																																
anthracite	soft, for hard floor																																
black	soft, for hard floor																																
dark blue	soft, for hard floor																																
<p>Tec 24-hour swivel chair</p> <p>with fully upholstered high backrest and head rest (87 cm). Head rest height adjustable. T-armrests adjustable in height and width.</p> <p>Reinforced steel mechanism, load up to 150 kg bodyweight.</p> <p>Synchronous mechanism with infinitely adjustable counterpressure of backrest.</p> <p>Synchronous movement infinitely arrestable.</p> <p>Seat tilt -4° and 6 cm seat depth adjustment.</p> <p>AGR-quality seal</p> <p>Seat-width: 500 mm Seat-depth: 380-440 mm Backrest-height: 870-1020 mm</p>		<table border="0"> <tr> <td>Upholstery</td> <td>Castors</td> </tr> <tr> <td>Footbase aluminium polished</td> <td></td> </tr> <tr> <td>anthracite</td> <td>hard, for carpeted floor</td> </tr> <tr> <td>black</td> <td>hard, for carpeted floor</td> </tr> <tr> <td>dark blue</td> <td>hard, for carpeted floor</td> </tr> <tr> <td>anthracite</td> <td>soft, for hard floor</td> </tr> <tr> <td>black</td> <td>soft, for hard floor</td> </tr> <tr> <td>dark blue</td> <td>soft, for hard floor</td> </tr> </table> 	Upholstery	Castors	Footbase aluminium polished		anthracite	hard, for carpeted floor	black	hard, for carpeted floor	dark blue	hard, for carpeted floor	anthracite	soft, for hard floor	black	soft, for hard floor	dark blue	soft, for hard floor	<p>S2-7A S2-7B S2-7C S2-7D S2-7E S2-7F</p>														
Upholstery	Castors																																
Footbase aluminium polished																																	
anthracite	hard, for carpeted floor																																
black	hard, for carpeted floor																																
dark blue	hard, for carpeted floor																																
anthracite	soft, for hard floor																																
black	soft, for hard floor																																
dark blue	soft, for hard floor																																

Chairs

Office swivel chair / Work swivel chair

Technical Data

Description			Order-no.
<p>Tec 10 Office swivel chair</p> <p>with molded seat and high backrest (59 cm), height adjustable 6 cm.</p> <p>Synchronous mechanism with infinitely adjustable counterpressure of backrest. Seat tilt -4°.</p> <p>Seat-width: 490 mm Seat-depth: 390 mm Backrest-high: 590-650 mm</p> <p>Optionally available with armrests! can be retrofitted</p>	 	<p>Upholstery Castors</p> <p>Footbase plastic black</p> <p>anthracite hard, for carpeted floor black hard, for carpeted floor dark blue hard, for carpeted floor</p> <p>anthracite soft, for hard floor black soft, for hard floor dark blue soft, for hard floor</p> <p>Footbase aluminium polished</p> <p>anthracite hard, for carpeted floor black hard, for carpeted floor dark blue hard, for carpeted floor</p> <p>anthracite soft, for hard floor black soft, for hard floor dark blue soft, for hard floor</p> 	<p>S7-1A S7-1B S7-1C</p> <p>S7-1D S7-1E S7-1F</p> <p>S7-1A X01 S7-1B X01 S7-1C X01</p> <p>S7-1D X01 S7-1E X01 S7-1F X01</p> <p>S7-1X</p>
<p>Tec 10 Worke swivel chair</p> <p>with medium high upholstery backrest (55 cm), height adjustable 7 cm.</p> <p>Tapered backrest for optimized shoulder room.</p> <p>Synchronous mechanism with 5-fold arrestable synchronous movement. Preselectable seat tilt (-1° or -5°) and 5 cm seat depth adjustment.</p> <p>AGR-quality seal</p> <p>Seat-width: 490 mm Seat-depth: 360-410 mm Backrest-high: 550-620 mm</p> <p>Optionally available with armrests! can be retrofitted</p>	  	<p>Upholstery Castors</p> <p>Footbase plastic black</p> <p>anthracite hard, for carpeted floor black hard, for carpeted floor dark blue hard, for carpeted floor</p> <p>anthracite soft, for hard floor black soft, for hard floor dark blue soft, for hard floor</p> <p>Footbase aluminium polished</p> <p>anthracite hard, for carpeted floor black hard, for carpeted floor dark blue hard, for carpeted floor</p> <p>anthracite soft, for hard floor black soft, for hard floor dark blue soft, for hard floor</p> <p>Footbase aluminium polished with push handle</p> <p>anthracite hard, for carpeted floor black hard, for carpeted floor dark blue hard, for carpeted floor</p> <p>anthracite soft, for hard floor black soft, for hard floor dark blue soft, for hard floor</p> 	<p>S7-2A S7-2B S7-2C</p> <p>S7-2D S7-2E S7-2F</p> <p>S7-2A X01 S7-2B X01 S7-2C X01</p> <p>S7-2D X01 S7-2E X01 S7-2F X01</p> <p>S7-2A X02 S7-2B X02 S7-2C X02</p> <p>S7-2D X02 S7-2E X02 S7-2F X02</p> <p>S7-2C</p>

Chairs

Work swivel chair



Technical Data

Description		Upholstery Castors	Order-no.
<p>Factory Tec 4 Work swivel chair</p> <p>with medium high upholstery backrest (55 cm), height adjustable 7 cm.</p> <p>Tapered backrest for optimized shoulder room.</p> <p>Synchronous mechanism with 5-fold arrestable synchronous movement.</p> <p>Preselectable seat tilt (-1° or -5°) and 5 cm seat depth adjustment.</p> <p>AGR-quality seal</p> <p>Seat-high: 450- 610 mm Seat-width: 490 mm Seat-depth: 360-410 mm Backrest-high: 550-620 mm</p>	 	<p>Upholstery Castors</p> <p>Footbase plastic black black hard, for carpeted floor</p> <p>black soft, for hard floor</p> <p>Footbase aluminium polished black hard, for carpeted floor</p> <p>black soft, for hard floor</p> <p>Color black</p> 	<p>S7-5A</p> <p>S7-5B</p> <p>S7-5A X01</p> <p>S7-5B X01</p>
<p>Factory Tec 8 Ergo-stools</p> <p>height adjustable with tiltable seat.</p> <p>Seat tilt from -4° to -12°, arrestable.</p> <p>Seat-high: 450-580 mm Seat-width: 400 mm Seat-depth: 300 mm</p>	 	<p>Upholstery Castors</p> <p>Footbase aluminium polished anthracite hard, for carpeted floor black hard, for carpeted floor dark blue hard, for carpeted floor</p> <p>anthracite soft, for hard floor black soft, for hard floor dark blue soft, for hard floor</p>  <p>Upholstery Castors</p> <p>Saddle seat PU, soft</p> <p>black hard, for carpeted floor black soft, for hard floor</p> 	<p>S3-8A</p> <p>S3-8B</p> <p>S3-8C</p> <p>S3-8D</p> <p>S3-8E</p> <p>S3-8F</p> <p>S3-8P</p> <p>S3-8Q</p>

Chairs

Work swivel chair

Technical Data

Description			Order-no.
<p>Factory Tec 8 Work swivel chair</p> <p>with wooden design, backrest swinging, height adjustable 8 cm. Permanent contact mechanism, following the movement of upper body in each sitting position. Counterpressure of backrest for body weight of ca 60 kg. Backrest tilt from 80° to 125°. Additionally seat tilt up to -10°.</p> <p>Seat-width: 430 mm Seat-depth: 370 mm Backrest-high: 370-450 mm</p>		<p>Beech natural, clear varnished</p> 	<p>S4-4A</p>
<p>LuPo</p> <p>Air-cushioned swivel chair with swivel castors</p> <p>This chair is recommended by the Federal Association of German Back Exercise Schools.</p> <p>Seat base is made of PP with double-wall structure. The air cushion effect also applies. 3-D rocker mechanism towards the front, to the side and to the rear. Hard castors for soft floors. Colour of metallic parts arctic, black.</p> <p>Seat height: 450 - 550 mm; Seat width: 440 mm; Seat depth: 460 mm</p>		<p>dark red black-grey dark green dark blue dolphin grey orange</p>	<p>S4-1R S4-1S S4-1T S4-1U S4-1V S4-1W</p>

ESD- Chairs

To be able to carry out its tasks with full energy, healthy seating is indispensable.

Our specific products for ESD-areas provide optimal seating conditions, enabling to support people's efficiency permanently.



Technical features

- Upholstery with metal fibers ensures electrostatically conductivity
- Antistatic finish of the material reduces electrostatic charge
- Ergonomically designed seat and backrest upholstery
- Inclination and height of backrest can be adjusted to body measurements
- Conductivity according to DIN 61340-5-1, resistance $< 1 \times 10^6 \Omega$.

Seat technology



Permanent contact backrest with tension adjustment. Backrest follows the movements of the upper body constantly. Infinitely variable adjustment of counter pressure of the backrest for ca. 50 – 125 kg body weight. Inclination of backrest infinitely lockable.



















Synchron technology with 4° seat tilt (Syncro®-Tension). The seat and backrest follow the movements of the sitter synchronously at the correct angle. Infinite, immediately noticeable adjustment of the backrest counterpressure (=Tension) for approx. 50-125 kg body weight. Synchronised movement infinitely lockable. Option: Seat depth adjustment 6 cm (using sliding seat, 6-fold adjustable).

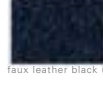

Synchronous mechanism with seat tilt (-5 °) and seat depth adjustment (5 cm). Ballpoint-Synchron® 2 mechanism, seat and backrest follow the movements of the seated person synchronously at the correct angle. Stepless adjustment of the backrest counterpressure while sitting (for approx. 50- 125 kg body weight). Synchronous movement can be locked 5 times. Self-explanatory adjustment buttons (ballpoint pen principle = ballpoint pen).

ESD- Chairs

Technical Data

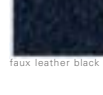
Description		ESD Upholstery	Order-no.	Order-no. with armrest
<p>ESD Chair Tec 400 Work swivel chair</p> <p>PF ST</p> <p>Automatic weight adjustment</p> <p>Seat height adjustment 430-590 mm</p> 		<p>ESD Upholstery</p>  <p>Black (BK)</p>  <p>Blue-Corinth (BU)</p>  <p>Blue-Indigo (DB)</p>  <p>faux leather black (IL)</p>	<p>black S8-E4.PFBK S8-E4.STBK</p> <p>blue corinth S8-E4.PFBU S8-E4.STBU</p> <p>blue indigo S8-E4.PFDB S8-E4.STDB</p> <p>faux leather S8-E4.PFIL S8-E4.STIL</p> <p>Clean Room S8-E4.STRR</p>	<p>black S8-E4.PFBK_A S8-E4.STBK_A</p> <p>blue corinth S8-E4.PFBU_A S8-E4.STBU_A</p> <p>blue indigo S8-E4.PFDB_A S8-E4.STDB_A</p> <p>faux leather S8-E4.PFIL_A S8-E4.STIL_A</p>
<p>ESD Chair Tec 600 Work swivel chair</p> <p>Design: medium high backrest</p> <p>PF ST</p> <p>Automatic weight adjustment</p> <p>Seat height adjustment 430-590 mm</p> 		<p>ESD Upholstery</p>  <p>Black (BK)</p>  <p>Blue-Corinth (BU)</p>  <p>Blue-Indigo (DB)</p>  <p>faux leather black (IL)</p>	<p>black S8-E6.PFBK S8-E6.STBK</p> <p>blue corinth S8-E6.PFBU S8-E6.STBU</p> <p>blue indigo S8-E6.PFDB S8-E6.STDB</p> <p>faux leather S8-E6.PFIL S8-E6.STIL</p> <p>Clean Room S8-E6.STRR</p>	<p>black S8-E6.PFBK_A S8-E6.STBK_A</p> <p>blue corinth S8-E6.PFBU_A S8-E6.STBU_A</p> <p>blue indigo S8-E6.PFDB_A S8-E6.STDB_A</p> <p>faux leather S8-E6.PFIL_A S8-E6.STIL_A</p>
<p>ESD Chair Tec 800 Work swivel chair</p> <p>Design: Tapered towards the top, 7 cm height adjustable</p> <p>ST BS 2</p> <p>Permanent contact backrest with spring force adjustment</p> <p>Seat height adjustment 440-600 mm</p> 		<p>ESD- Upholstery</p>  <p>Black (BK)</p>  <p>Blue-Corinth (BU)</p>  <p>Blue-Indigo (DB)</p>  <p>faux leather black (IL)</p>	<p>black S8-E8.PFBK S8-E8.STBK</p> <p>blue corinth S8-E8.PFBU S8-E8.STBU</p> <p>blue indigo S8-E8.PFDB S8-E8.STDB</p> <p>faux leather S8-E8.PFIL S8-E8.STIL</p> <p>Clean Room S8-E8.STRR</p>	<p>black S8-E8.PFBK_A S8-E8.STBK_A</p> <p>blue corinth S8-E8.PFBU_A S8-E8.STBU_A</p> <p>blue indigo S8-E8.PFDB_A S8-E8.STDB_A</p> <p>faux leather S8-E8.PFIL_A S8-E8.STIL_A</p>



















ESD- Chairs

Technical Data

Description	Order-no.
<p>ESD saddle seat stool</p> <p>Upholstery: ESD PU black Chair base: aluminium polished conductive</p> <p>Seat height adjustment 540-790 mm</p> 	 <p>saddle seat stool with castors</p> <p>saddle seat stool with foot ring and glides</p> <p>S8-EH.SAR</p> <p>S8-EH.SAFG</p>
<p>ESD tray seat stool</p> <p>Upholstery: ESD PU black</p> <p>Chair base: aluminium polished conductive Seat height adjustment 450-620 mm</p> 	 <p>tray seat stool with castors</p> <p>tray seat stool with foot ring and glides</p> <p>S8-EH.TER</p> <p>S8-EH.TEFG</p>
<p>ESD castor (Set)</p> <p>for ESD swivel chairs Tec 400/600/800</p> <p>1 Set = 5 pieces</p>	 <p>hard castors</p> <p>soft castors</p> <p>S8-EZ.Rollen_H</p> <p>S8-EZ.Rollen_W</p>
<p>ESD slieders (Set)</p> <p>for ESD swivel chairs Tec 400/600/800</p> <p>1 Set = 5 pieces</p>	 <p>S8-EZ.Gleiter</p>
<p>ESD footrest</p> <p>Height adjustment range from 5 to 23 cm</p> <p>anti-slip tread surface</p> <p>Loadable up to 100 kg</p>	 <p>Model Basic 950</p> <p>S8-EZ.FS01</p>
<p>ESD footrest</p> <p>Height adjustment range from 8 to 29 cm</p> <p>anti-slip tread surface</p> <p>Loadable up to 100 kg</p>	 <p>Model Basic 952</p> <p>S8-EZ.FS02</p>

ESD- Heavy Duty Work Chair

Technical Data

Description			Order-no.
<p>ESD swivel chair Tec XXS Ergonomic ESD heavy- duty work chair</p> <p>seat: 500 x 530 mm backrest: 460 x 500 mm incl. ESD armrests loaded up to 250 kg</p> 	 	<p>ESD- Upholstery</p>  <p>dralon anthracite grey (GR)</p>  <p>dralon dark blue (DB)</p>  <p>faux leather (LL)</p>	<p>Dralon anthracite grey S8-EX.XSGR</p> <p>Dralon dark blue S8-EX.XSDB</p> <p>faux leather S8-EX.XSIL</p>
<p>ESD swivel chair Tec XXM Ergonomic ESD heavy- duty work chair</p> <p>seat: 570 x 530 mm backrest: 460 x 500 mm incl. ESD armrests loaded up to 250 kg</p> 	 	<p>ESD- Upholstery</p>  <p>dralon anthracite grey (GR)</p>  <p>dralon dark blue (DB)</p>  <p>faux leather (LL)</p>	<p>Dralon anthracite grey S8-EX.XMGR</p> <p>Dralon dark blue S8-EX.XMDB</p> <p>faux leather S8-EX.XMIL</p>
<p>ESD swivel chair Tec XXL Ergonomic ESD heavy- duty work chair</p> <p>seat: 650 x 530 mm backrest: 560 x 500 mm incl. ESD armrests loaded up to 250 kg</p> 	 	<p>ESD- Upholstery</p>  <p>dralon anthracite grey (GR)</p>  <p>dralon dark blue (DB)</p>  <p>faux leather (LL)</p>	<p>Dralon anthracite grey S8-EX.XLGR</p> <p>Dralon dark blue S8-EX.XLDB</p> <p>faux leather S8-EX.XLIL</p>

J Conference Tables



J

J Conference Tables



J

Conference Tables

Supplementary to the Elabo furniture range, conference and meeting rooms can now be fitted in matching colours. A harmonious overall picture results if the conference stools also available are used.



Technical features

- Many attractive placement variants can be set up
- In just a few steps, the tables can be moved to form other configurations
- 19 mm-thick decorative chipboard panel with a fine structure
- Table top melamine resin-coated
- Corner radius 50 mm
- A 2 mm-thick plastic edge protects the tabletop against impacts or shocks
- The circumferential steel pipe rectangular frame is 50 mm high
- The table legs made of 40 mm round pipe can be dismantled
- The light grey metal parts are powder coated

Conference Tables

Technical Data

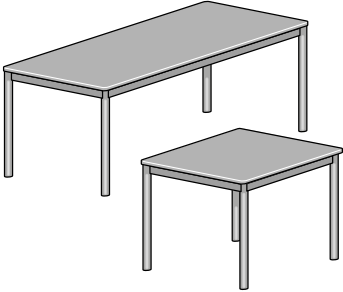
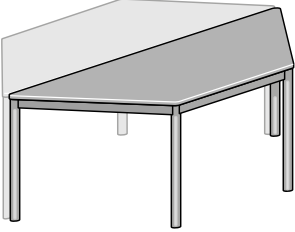
Description			Order-no.
Conference table		rectangular 600 mm x 800 mm x 720 mm 1200 mm x 800 mm x 720 mm square 800 mm x 800 mm x 720 mm	08-1A 08-1B 08-1C
Conference table		trapezoidal 1600 mm x 800 mm x 720 mm (800 mm)	08-1D

Placement Variants

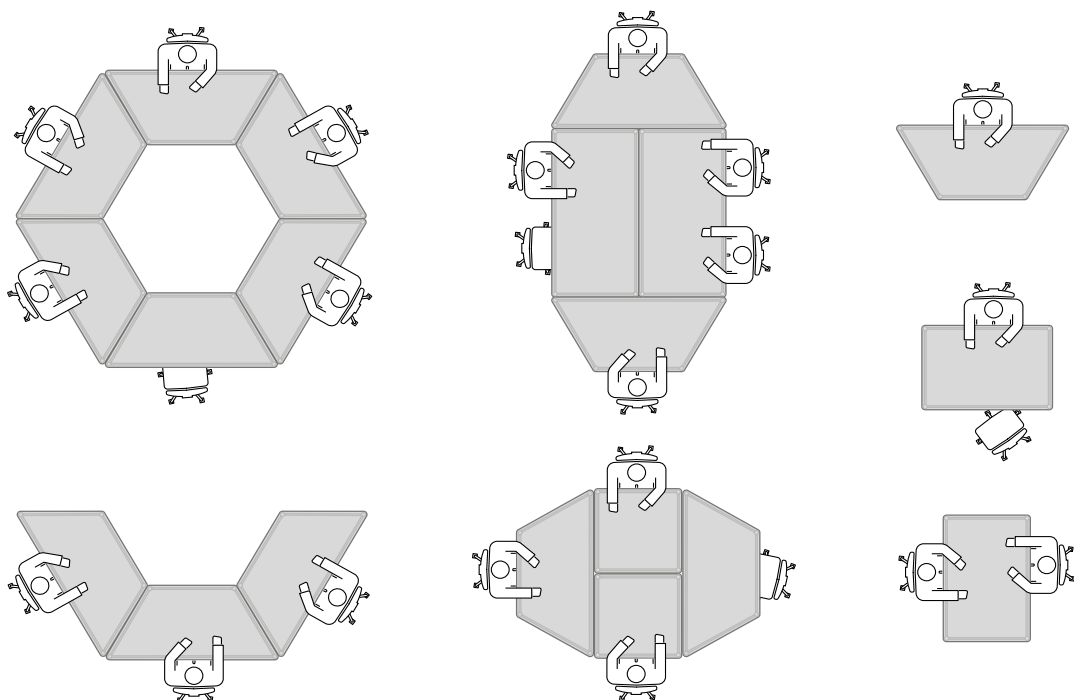

K Storage



Table of contents

K1 Laboratory tall cabinets	441	441
K2 Office tall cabinets		455



Laboratory tall cabinets

K1

Laboratory tall cabinets

The construction of entire walls of cabinets is achieved through the use of a single base element – and depending on the desired overall cabinet width – and through the stringing together of several attachment elements. Cabinet doors with glazing in the entire height of the doors is available for professional room furnishings. The rotary bar closing mechanism is covered thereby with a light grey panel made of coated chipboard. The glass doors are made of 4 mm ESG glass (single-pane safety glass).

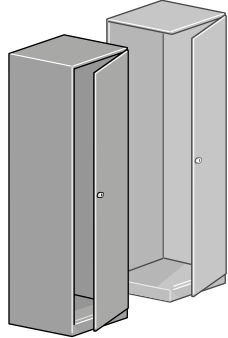
Technical Data

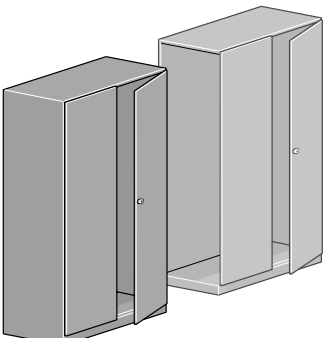
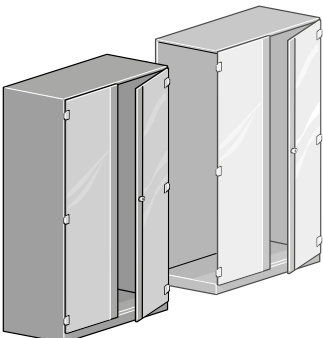
Description		Order-no.
<p>Tall cabinet Single door</p> <p>1 folding door, right 1 Handle with integrated lock Base element</p> <p>Attachment element Also available with radio technology (closure via trans- ponder)</p>		<p>520 mm x 600 mm x 2045 mm 500 mm x 600 mm x 2045 mm</p> <p>07-1A 07-1E</p>
<p>Tall cabinet Single door glazed</p> <p>1 folding door, right, glazed the entire height of the door 1 Handle with integrated lock Base element</p> <p>Attachment element</p> <p>Also available with radio technology (closure via trans- ponder)</p>		<p>520 mm x 600 mm x 2045 mm 500 mm x 600 mm x 2045 mm</p> <p>07-1B 07-1F</p>
<p>Tall cabinet Two-door</p> <p>2 folding doors 1 Handle with integrated lock Base element</p> <p>Attachment element</p> <p>Also available with radio technology (closure via trans- ponder)</p>		<p>1020 mm x 600 mm x 2045 mm 1000 mm x 600 mm x 2045 mm</p> <p>07-1C 07-1G</p>
<p>Tall cabinet Two-door glazed</p> <p>2 folding doors, glazed the entire height of the door 1 Handle with integrated lock Base element</p> <p>Attachment element</p> <p>Also available with radio technology (closure via trans- ponder)</p>		<p>1020 mm x 600 mm x 2045 mm 1000 mm x 600 mm x 2045 mm</p> <p>07-1D 07-1H</p>

Laboratory tall cabinets

Rack elements fit precisely onto the base and mounting elements. They are produced in accordance with the room dimensions. Remaining space can be shut off flush with the room ceiling using a panel. The front doors are standard-fitted with a handle which has no lock.

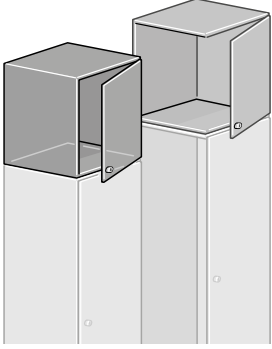
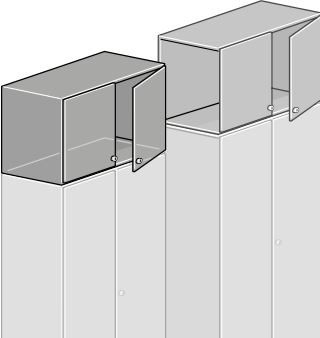
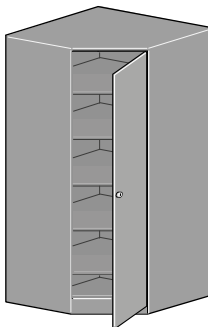
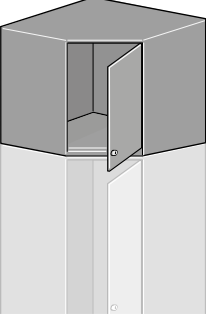

Technical Data

Description			Order-No.
<p>Rack element Single door</p> <p>1 folding door right 1 handle</p> <p>Base element Attachment element</p> <p>Also available with radio technology (closure via transponder)</p>		<p>520 mm x 600 mm x max. 980 mm 500 mm x 600 mm x max. 980 mm</p> <p>Z = Please specify required height</p>	<p>07-1JZ 07-1LZ</p>
<p>Rack element Two-door</p> <p>2 folding doors 1 handle</p> <p>Base element Attachment element</p> <p>Also available with radio technology (closure via transponder)</p>		<p>1020 mm x 600 mm x max. 980 mm 1000 mm x 600 mm x max. 980 mm</p> <p>Z = Please specify required height.</p>	<p>07-1KZ 07-1MZ</p>
<p>Corner base element Single door</p> <p>1 folding door right handle with lock 5 height-adjustable shelves 19 mm thick</p>		<p>965 mm x 600 mm x 2045 mm</p>	<p>07-1Q</p>
<p>Corner rack element Single door</p> <p>1 folding door right 1 handle</p>		<p>965 mm x 600 mm x max. 980 mm</p> <p>Z = Please specify required height</p>	<p>07-1RZ</p>

Tall cabinets

The complete cabinets are already provided with furnishing elements. The integrated organisation aids can be modified or supplemented at any time as a result of the 32 mm European fitting grid. Sliding door cabinets require no open space for opening. In the event of space restrictions in narrow room layouts, this can be an advantage over the folding door version.

Technical Data

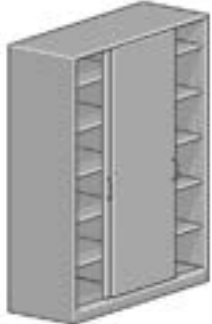
Description			Order-no.
<p>Complete cabinet with shelves</p> <p>2 folding doors 1 handle with lock 5 height-adjustable shelves</p> <p>Also available with radio technology (closure via transponder)</p>		1020 mm x 600 mm x 2045 mm	07-1V
<p>Elabo tall cabinet</p> <p>Equipment: 2 swing doors, 1 center wall, 2 x 6 height-adjustable shelves, 2 x 5-piece set of grooved mats</p> <p>Shelf dimensions: W = 480, D = 540, H = 19 mm</p>		1020 mm x 600 mm x 2045 mm	07-1W
<p>Complete cabinet With sliding doors</p> <p>2 sliding doors 1 lock 1 centre wall 2 x 5 height-adjustable shelves</p>		1220 mm x 600 mm x 2045 mm	07-1X

Laboratory tall cabinets

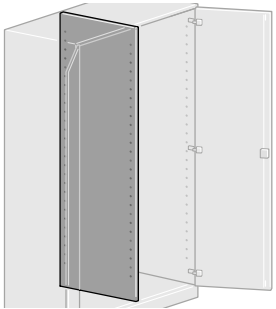
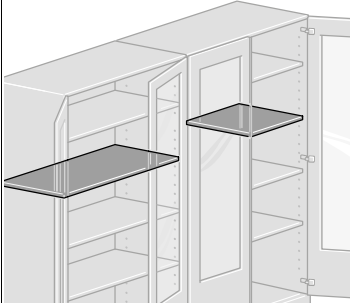
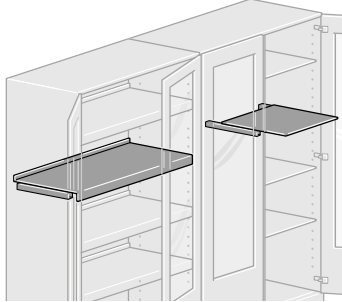
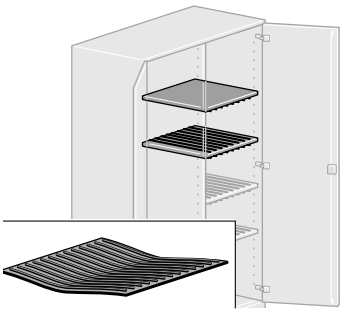

A multitude of different organisation elements can be fitted into Elabo laboratory cabinet systems. This allows you to realise flexible, user-friendly solutions.

Technical Data

Description			Order-No.
<p>Centre wall</p> <p>For base and attachment elements with grid width 1000 mm</p>		<p>16 mm x 540 mm x 1930 mm</p>	<p>07-1P</p>
<p>Shelves</p> <p>For cabinets with grid width of 500 mm Wood, capacity 35 kg Metal, capacity 100 kg</p> <p>For cabinets with grid width of 1000 mm Wood, capacity 25 kg Wood, capacity 50 kg Metal, capacity 100 kg</p>		<p>480 mm x 540 mm x 19 mm 480 mm x 540 mm x 25 mm</p> <p>980 mm x 540 mm x 19 mm 980 mm x 540 mm x 25 mm 980 mm x 540 mm x 25 mm</p>	<p>07-2A 07-2U</p> <p>07-2L 07-2M 07-2W</p>
<p>Shelves Extendable</p> <p>Partial pullout for cabinets with grid width of 500 mm Capacity 27 kg</p> <p>Full pullout for front and rear upturned edge, for cabinets with grid width of 1000 mm Capacity 47 kg</p>		<p>480 mm x 540 mm x 19 mm</p> <p>980 mm x 540 mm x 163 mm</p>	<p>07-2B</p> <p>07-2P</p>
<p>Shelves With grooved mats</p> <p>19 mm thick, With grooved mats 10 mm thick,</p> <p>For the storage of experiment boards, for cabinets with grid width of 500 mm Coated on one side Coated both sides</p> <p>PVC grooved mats, loose Note- The grooved mat must be adapted manually; please use screws or high-strength adhesive.</p>		<p>480 mm x 540 mm x 25 mm 480 mm x 540 mm x 39 mm</p> <p>480 mm x 540 mm x 10 mm</p>	<p>07-2C 07-2D</p> <p>07-9E</p>

Laboratory tall cabinet accessories

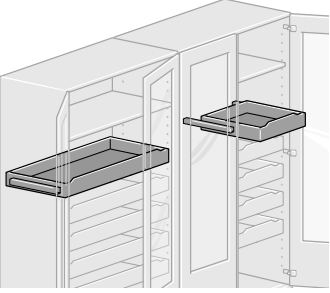
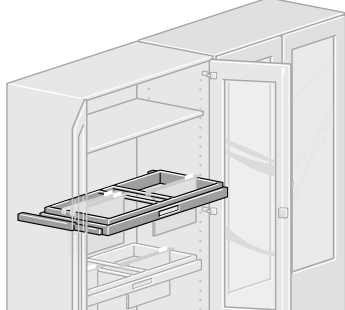
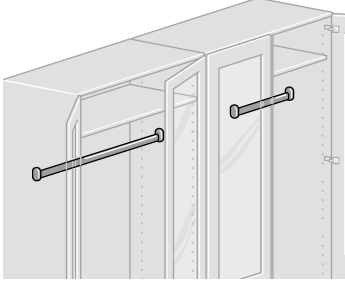

Technical Data

Description			Order-no.
<p>Drawers</p> <p>Inside wooden drawer With partial pullout, for cabinets with grid width of 500 mm, Capacity 25 kg</p> <p>Inside steel plate drawer with full telescoping pullout, for cabinets with a grid width of 1000 mm, Capacity 70 kg</p>		<p>480 mm x 505 mm x 94 mm</p> <p>908 mm x 490 mm x 85 mm</p>	<p>07-2E</p> <p>07-2Q</p>
<p>Hanging filing system</p> <p>For A4 hanging bags, longitudinal or transverse, With full telescopic pullout, For cabinets with grid width of 1000 mm, Capacity 70 kg</p>		<p>980 mm x 540 mm x 100 mm Effective height 300 mm</p>	<p>07-2R</p>
<p>Clothes racks</p> <p>Clothes rack with chromeplated oval pipe with fastening elements, for cabinets with grid widths of 500 mm</p> <p>Clothes rack with chromeplated oval pipe with fastening elements, for cabinets with grid widths of 1000 mm</p>		<p>Length 480 mm</p> <p>Length 980 mm</p>	<p>07-2F</p> <p>07-2S</p>
<p>Quick step</p> <p>Roller step stool made of steel, with 3 lowerable, sprung swivel castors and castors. Easy-running in any direction without strain, sturdy under strain. Extra-wide standing space with ribbed plastic pad. Allround impact protection, base part with rubber edging. Colour: white/black Roller step stool Dimensions</p>		<p>Diameter bottom 450 mm Diameter at top 290 mm Height 20 mm</p>	<p>07-9Q</p>

Laboratory tall cabinet accessories

The ladder frame is an expedient supplement to the room-height cabinet wall system. The rack elements can be easily and comfortably reached using the hanging or fixed-mounted light metal ladder. Locking systems (available from Elabo at no extra charge) have to be designed precisely according to the customer's requirements. Elabo lock cylinders fulfil these requirements. We would be happy to advise you.

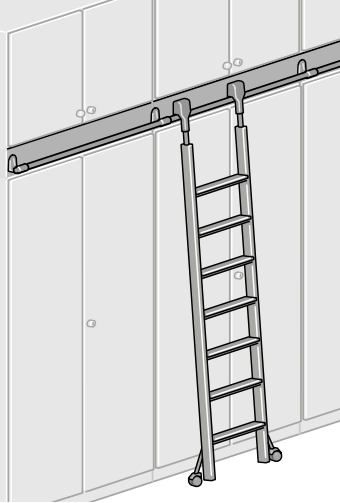
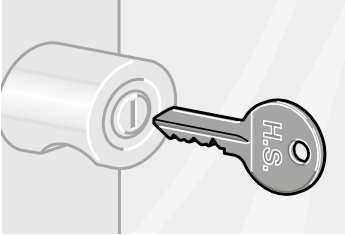
Technical Details

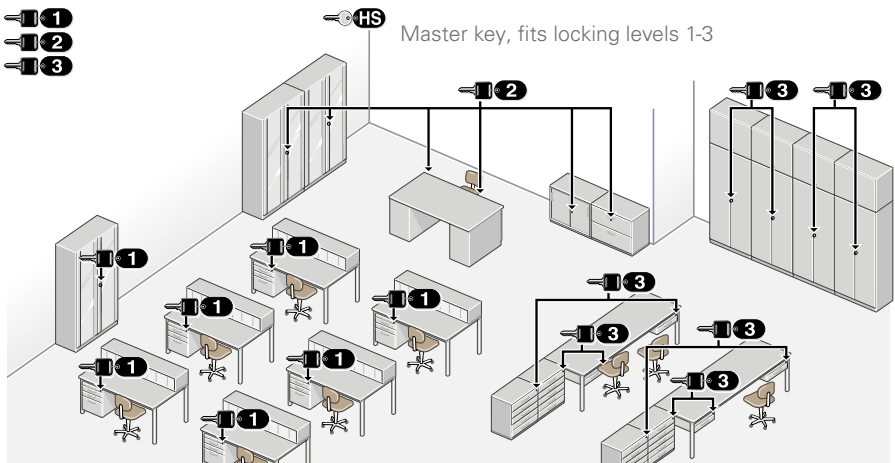
Description			Order-no.
<p>Cabinet wall ladder</p> <p>The guide pipe for ladder guidance is mounted between the basic and the rack cabinets onto an additional intermediate cabinet panel.</p> <p>7-level light metal ladder, secured against removal, TÜV (Technical Inspectorate) tested, secure standing due to roller stops.</p> <p>8-level light metal ladder, removable, suitable for hanging into a ladder guide but without rollers.</p> <p>Z = Please specify length</p>		<p>160 mm x 65 mm x 1000 mm</p> <p>400 mm x 87 mm x 2230 mm</p> <p>400 mm x 87 mm x 2230 mm</p>	<p>07-9KZ</p> <p>07-9M</p> <p>07-9N</p>
<p>Master key</p> <p>Locking with closing bar for rack elements</p> <p>Main key for shared locker system (tall cabinets, base cabinets, side cabinets), lock cylinders can be replaced</p>		<p>Lock with locking bar for rack cabinet-elements</p> <p>Master key for central locking system (tall cabinets, underbench cabinets, side cabinets) Locking cylinder replaceable</p>	<p>07-9D</p> <p>07-9C</p>
<p>Transponder</p> <p>Digital locking system with locking plan software for contactless opening of cabinets, base cabinets, doors and for the release of electronic superstructures. If required, the entire building locking technology can be connected with the system. In order to prevent misuse, communication of the digital components takes place via a consistently changing crypto code.</p>		<p>Dimensions in mm</p>	<p>07-9T Z</p>
<p>Locking systems Example</p>	 <p>1, 2, 3 (key types)</p> <p>HS Master key, fits locking levels 1-3</p>		

Laboratory tall cabinet organisation aids

Steel plate drawers for side and tall cabinets have the same construction design as base cabinets and can also be equipped with partitions and compartment dividers. In the case of wide steel plate drawers, an additional set of perforated grid strips is required. Moulded trays can also be used.

Technical Data

Description	Order-no.		
<div style="text-align: center;"> <p style="text-align: center;">Wooden drawer inside (Figure with moulded trays) Internal dimensions: D = 470 mm, W = 410 mm, H = 70 mm For tall cabinets, width 520 mm, 1020 mm with centre wall</p> </div> <div style="display: flex; justify-content: space-around; margin-top: 20px;"> <div style="width: 30%;"> <p>Steel plate drawer with panel Internal dimensions: D = 490 mm W = 327 mm for side cabinets W = 420 mm</p> </div> <div style="width: 30%;"> <p>Steel plate drawer with panel Internal dimensions: D = 490 mm, W = 1090 mm for side cabinets W = 1200 mm</p> </div> <div style="width: 30%;"> <p>Steel plate drawer with panel inside Internal dimensions: D = 490 mm, W = 890 mm for tall cabinets W = 1020 mm</p> </div> </div>			
<p>Partitions</p> <p>Partition, black metal</p> <p>Partition, black metal, for wide drawers</p>		<p>326 mm x 10 mm x 75 mm</p> <p>490 mm x 10 mm x 75 mm</p>	<p>07-7A</p> <p>07-7B</p>
<p>Compartment divider</p> <p>(1) Compartment divider A4 black metal</p> <p>(2) Compartment divider A5 black metal</p> <p>(3) Compartment divider A6 black metal</p>		<p>310 mm x 1 mm x 72 mm</p> <p>220 mm x 1 mm x 72 mm</p> <p>150 mm x 1 mm x 72 mm</p>	<p>07-7C</p> <p>07-7D</p> <p>07-7E</p>
<p>Orga Clip</p> <p>Partition wall can be positioned flexibly in the drawer.</p> <p>Material: plastic</p> <p>Packaging unit: 10 pcs</p>			<p>07-1V</p>

Laboratory side cabinets



The side cabinet system partition is identical in construction, quality and colour with the laboratory tall cabinet system. Open shelves, folding doors, shutter doors and sliding door cabinets are available. Side cabinets for storing DIN A4 hanging bags are available as well as designs with steel plate drawers. The front panels have a sturdy, ergonomic bracket handle.

Side cabinets with sliding doors have a pressure safety lock. The cabinets with drawers have a central lock with mutual door locking. All locks are adaptable for locking systems and master keys. With the accessory elements of base, storage tray and cover plate, the base cabinets can be connected together in many different ways to form larger functional units.

Side cabinets placed on top of each other – with optional integrated storage tray – can be used for the configuration of simple partition solutions – also for use on alternating sides. The free cabinet rear walls can also be used as an information area with a pinboard or a steel rear wall for writing on.

Laboratory side cabinets

Laboratory side cabinets available in 3 widths and in 2 heights (file heights). The depth is a uniform 600 mm, just as with the tall cabinets. The drawer cabinets have steel plate drawers with perforations and the same arrangement system as is to be generally found with the Elabo base cabinet or tall cabinet drawers. The shelves are height-adjustable in 32 mm grids.

Technical Data

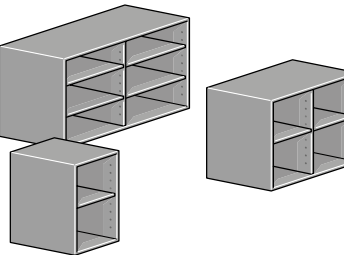
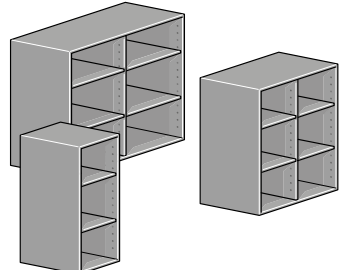
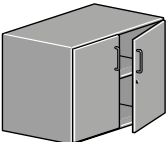
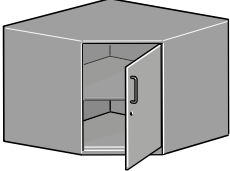
Description			Order-no.
<p>Side shelf</p> <p>1 shelf</p> <p>With centre wall 2 shelves</p> <p>With centre wall 2 shelves</p>		<p>420 mm x 600 mm x 720 mm</p> <p>820 mm x 600 mm x 720 mm</p> <p>1200 mm x 600 mm x 720 mm</p>	<p>08-2A</p> <p>08-2B</p> <p>08-2C</p>
<p>Side shelf</p> <p>2 shelves</p> <p>With centre wall 4 shelves</p> <p>With centre wall 4 shelves</p>		<p>420 mm x 600 mm x 1100 mm</p> <p>820 mm x 600 mm x 1100 mm</p> <p>1200 mm x 600 mm x 1100 mm</p>	<p>08-3A</p> <p>08-3B</p> <p>08-3C</p>
<p>Side cabinet</p> <p>With folding doors and centre wall 2 shelves</p>		<p>820 mm x 600 mm x 720 mm</p>	<p>08-2D</p>
<p>Corner side cabinet with folding doors</p> <p>1 folding door right 1 height-adjustable shelf, 19 mm thick</p> <p>Base</p>		<p>965 mm x 600 mm x 720 mm</p> <p>965 mm x 600 mm x 30 mm</p> <p>965 mm x 600 mm x 80 mm</p>	<p>08-2Q</p> <p>08-4U</p> <p>08-4V</p>

Laboratory side cabinets

The Elabo partition side cabinets can be used for almost any room layout. A room fitted with these products always remains flexible; any conversions required can be carried out quickly and in a few steps. Several side cabinets placed in rows can be covered with one single cover plate.

Technical Data

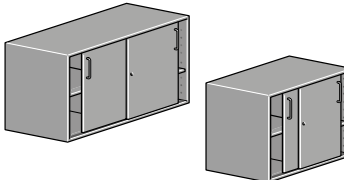
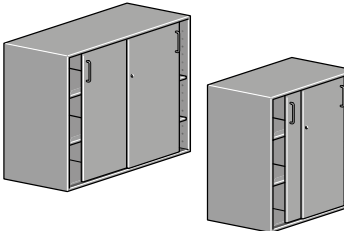
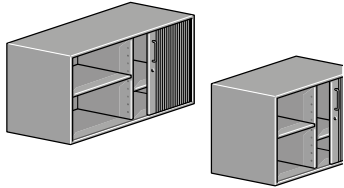
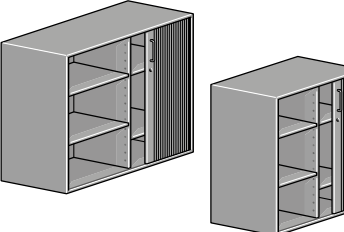
Description			Order-no.
<p>Side cabinet with sliding doors</p> <p>Centre wall 2 shelves</p>		<p>820 mm x 600 mm x 720 mm 1200 mm x 600 mm x 720 mm</p>	<p>08-2E 08-2F</p>
<p>Side cabinet with sliding doors</p> <p>Centre wall 4 shelves</p>		<p>820 mm x 600 mm x 1100 mm 1200 mm x 600 mm x 1100 mm</p>	<p>08-3E 08-3F</p>
<p>Side cabinet with roller shutters</p> <p>Centre wall 2 shelves</p>		<p>820 mm x 600 mm x 720 mm 1200 mm x 600 mm x 720 mm</p>	<p>08-2G 08-2H</p>
<p>Side cabinet with roller shutters</p> <p>Centre wall 2 shelves</p>		<p>820 mm x 600 mm x 1100 mm 1200 mm x 600 mm x 1100 mm</p>	<p>08-3G 08-3H</p>

Laboratory side cabinets

The drawer side cabinets are equipped with black coated steel plate inserts. Full telescopic pullouts allows loads of up to 45 kg. The consistent organisation system for all Elabo steel plate drawers ensures flexible organisation for any requirements.

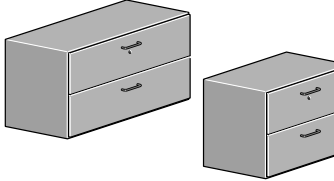
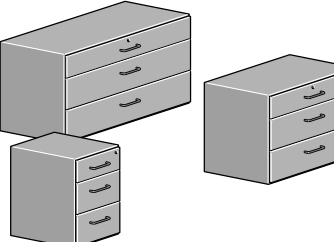
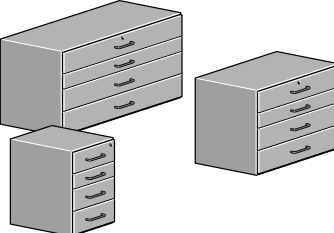
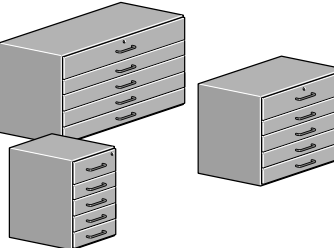

Technical Data

Description			Order-no.
<p>Side cabinet with hanging filing system</p> <p>2 fold 2 x A4 crosswise</p> <p>2 fold 3 x A4 crosswise</p>		<p>820 mm x 600 mm x 720 mm</p> <p>1200 mm x 600 mm x 720 mm</p>	<p>08-2J</p> <p>08-2K</p>
<p>Side cabinet with drawers</p> <p>3 drawers</p> <p>3 + 4 + 4 HE</p>		<p>420 mm x 600 mm x 720 mm</p> <p>820 mm x 600 mm x 720 mm</p> <p>1200 mm x 600 mm x 720 mm</p>	<p>08-2M</p> <p>08-2R</p> <p>08-2U</p>
<p>Side cabinet with drawers</p> <p>4 drawers</p> <p>3 + 2 + 3 + 3 HE</p>		<p>420 mm x 600 mm x 720 mm</p> <p>820 mm x 600 mm x 720 mm</p> <p>1200 mm x 600 mm x 720 mm</p>	<p>08-2N</p> <p>08-2S</p> <p>08-2V</p>
<p>Side cabinet with drawers</p> <p>5 drawers</p> <p>3 + 2 + 2 + 2 + 2 HE</p>		<p>420 mm x 600 mm x 720 mm</p> <p>820 mm x 600 mm x 720 mm</p> <p>1200 mm x 600 mm x 720 mm</p>	<p>08-2P</p> <p>08-2T</p> <p>08-2W</p>

Laboratory side cabinet accessories

Whether setting up these products back-to-back or mounted above each other - all the prerequisites are fulfilled for flexible room design. The optional storage tray, placed between two elements, provides an ideal place to put files.

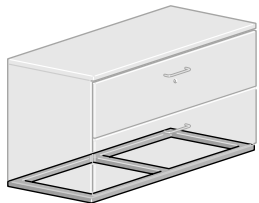
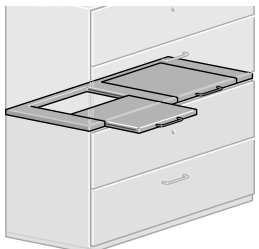
Technical Data

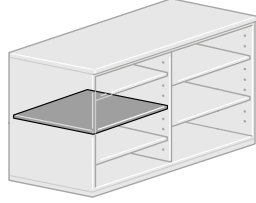
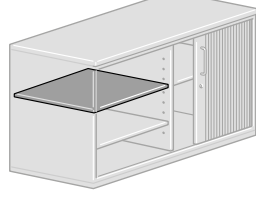
Description			Order-no.
<p>Base</p> <p>For side cabinets W = 420 mm For side cabinets W = 820 mm For side cabinets W = 1200 mm</p> <p>For side cabinets W = 420 mm For side cabinets W = 820 mm For side cabinets W = 1200 mm</p>		<p>420 mm x 600 mm x 30 mm 820 mm x 600 mm x 30 mm 1200 mm x 600 mm x 30 mm</p> <p>420 mm x 600 mm x 80 mm 820 mm x 600 mm x 80 mm 1200 mm x 600 mm x 80 mm</p>	<p>08-4A 08-4B 08-4C</p> <p>08-4R 08-4S 08-4T</p>
<p>Storage Tray element</p> <p>1 fold</p> <p>2 fold</p>		<p>420 mm x 600 mm x 19 mm 820 mm x 600 mm x 19 mm</p> <p>1200 mm x 600 mm x 19 mm</p>	<p>08-4E 08-4F</p> <p>08-4G</p>
<p>Cover plate</p> <p>For side cabinets W = 420 mm For side cabinets W = 820 mm For side cabinets W = 1200 mm</p> <p>For corner side cabinet</p> <p>As an alternative, one-piece cover plates can be laid over several side cabinets.</p>		<p>426 mm x 610 mm x 30 mm 826 mm x 610 mm x 30 mm 1206 mm x 610 mm x 30 mm</p> <p>971 mm x 610 mm x 30 mm</p>	<p>08-4K 08-4L 08-4M</p> <p>08-4X</p>
<p>Additional shelf</p> <p>For side cabinets W = 420/820 mm For side cabinets W = 1200 mm</p> <p>For side cabinet 08-2D</p>		<p>380 mm x 520 mm x 19 mm 570 mm x 520 mm x 19 mm</p> <p>380 mm x 540 mm x 19 mm</p>	<p>08-5A 08-5C</p> <p>08-5E</p>
<p>Additional shelf for roller shutter cabinets</p> <p>For roller shutter cabinets W = 820 mm</p> <p>For roller shutter cabinets W = 1200 mm</p>		<p>340 mm x 490 mm x 19 mm</p> <p>530 mm x 490 mm x 19 mm</p>	<p>08-5B</p> <p>08-5D</p>

Laboratory side cabinets

The rear walls on the partition elements can also be used. Mounting a pinboard or a steel plate surface for writing on provides an expedient method of communication. Pinboard design and powder coated steel plate in white. Simply installation using double-sided tape.

Technical Data

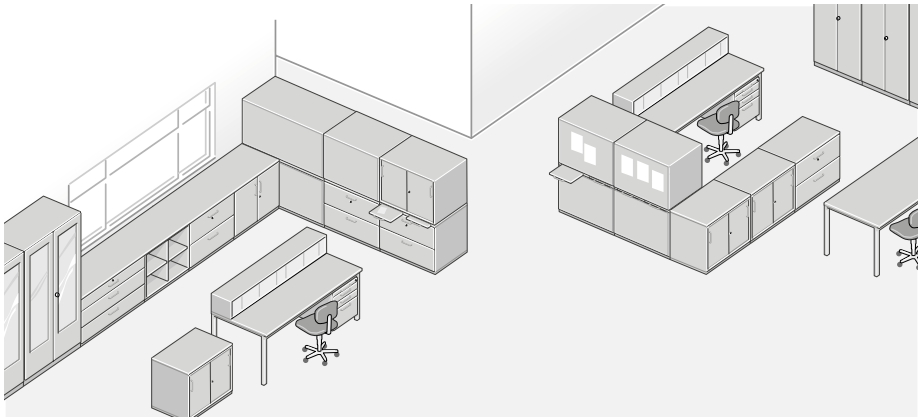
Description			Order-no.
<p>Pinboard</p> <p>For cabinet dimension For cabinet dimension For cabinet dimension</p> <p>For cabinet dimension For cabinet dimension</p>		<p>Width = 379 mm x Depth = 681 mm Width = 779 mm x Depth = 681 mm Width = 1159 mm x Depth = 681 mm</p> <p>Width = 779 mm x Depth = 1061 mm Width = 1159 mm x Depth = 1061 mm</p>	<p>09-7A 09-7B 09-7C</p> <p>09-8B 09-8C</p>
<p>Partition elements</p>			



Office tall cabinets

K2

Office tall cabinets



Technical features

On the office systems, the grid widths and the drawer depths (lower file depth) are different than on the laboratory cabinet systems.

The technical design of the office cabinet system is however identical to that of the laboratory cabinet system. The laboratory and office cabinet systems can easily be combined with each other by using the same fittings, materials and surfaces.

Basic and mounting cabinet elements, corner elements and rack elements are also available.

Cabinet walls adapted to the millimetre are also part of the Elabo range. Additional equipment for office cabinets with rack elements such as ladder frames, aluminium ladders or step stools can be used which are of the same construction as the laboratory cabinet system products.

Office tall cabinets

Whole cabinet walls can be configured cheaply and attractively using a basic cabinet element and further mounting elements. If required, the cabinets can assume practical partition functions by doubling the rear walls.

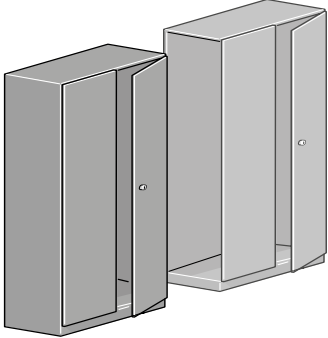
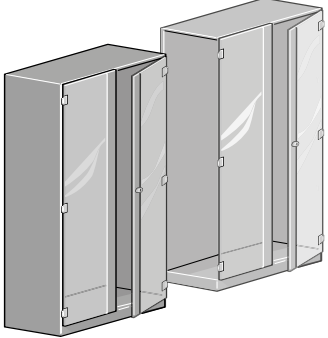
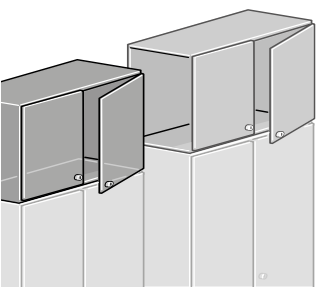
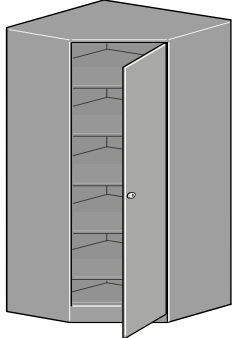

Technical Data

Description			Order-no.
<p>Tall Cabinet two doors</p> <p>2 folding doors 1 handle with lock</p> <p>Base element Attachment element</p>		<p>820 mm x 440 mm x 2045 mm 800 mm x 440 mm x 2045 mm</p>	<p>07-4A 07-4B</p>
<p>Tall Cabinet two-door, glazed</p> <p>2 folding doors glazed the entire height of the door 1 handle with lock</p> <p>Base element Attachment element</p>		<p>820 mm x 440 mm x 2045 mm 800 mm x 440 mm x 2045 mm</p>	<p>07-4L 07-4M</p>
<p>Rack element two-door</p> <p>2 folding doors 1 handle</p> <p>Base element Attachment element</p> <p>Z = Please specify required height</p>		<p>820 mm x 440 mm x max. 980 mm 800 mm x 440 mm x max. 980 mm</p>	<p>07-4CZ 07-4DZ</p>
<p>Basic-corner-elements single-door</p> <p>1 folding door right</p> <p>Base element 1 handle with lock 5 height-adjustable shelves 19 mm thick</p> <p>Base element rack 1 handle</p>		<p>765 mm x 440 mm x 2045 mm</p> <p>765 mm x 440 mm x max. 980 mm</p>	<p>07-4P</p> <p>07-4N</p>

Office complete cabinets

The preassembled combination cabinet solutions have proven their usefulness as versions for office areas. Behind the folding doors, files can be stored within easy reach. Hanging filing system full pullouts contain the necessary documents in DIN A4 format. The steel plate drawers provide storage for a wide variety of office utensils.

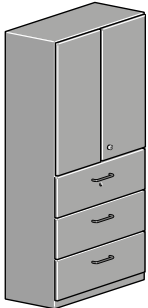
Technical Data

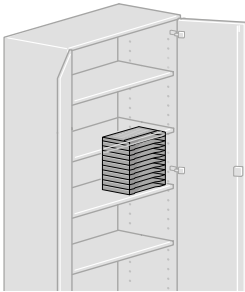
Description			Order-no.
<p>Complete cabinets with drawers</p> <ul style="list-style-type: none"> 2 folding doors 1 handle with lock 2 height-adjustable shelves 7 drawers 		820 mm x 440 mm x 2045 mm	07-4E
<p>Complete cabinets with hanging filing system</p> <ul style="list-style-type: none"> 2 folding doors 1 handle with lock 2 height-adjustable shelves 3 hanging file full pullouts for 2 x DIN A4 hanging files each 		820 mm x 440 mm x 2045 mm	07-4G
<p>Complete cabinets with hanging filing system</p> <ul style="list-style-type: none"> 2 sliding doors 1 lock 1 centre wall 4 height-adjustable shelves 2 storage tray 4 hanging file full pullouts for 2 x DIN A4 hanging files each 		1620 mm x 440 mm x 2045 mm	07-4J
<p>Form storage set with form storage set</p> <p>for forms sizes DIN A4 Grey plastic 11x, fits to all cabinet systems</p> <p>Colour: light grey</p>		326 mm x 210 mm x 330 mm	07-7Q

Office tall cabinet accessories

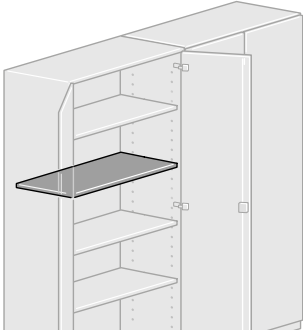
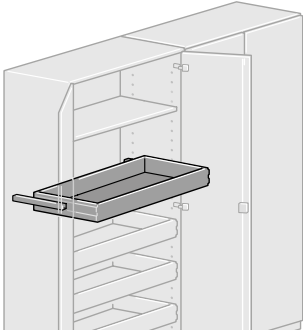
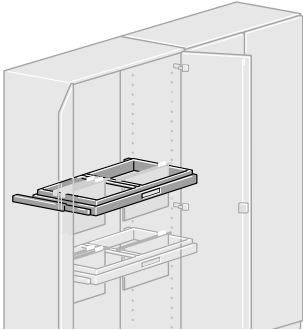
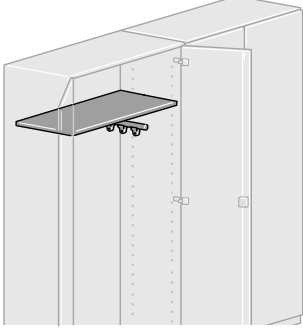

Technical Data

Description			Order-No.
<p>Shelf</p> <p>Melamine resin-coated both sides. Edge with impact-resistant edge strip</p>		780 mm x 380 mm x 19 mm	07-4Q
<p>Steel plate drawer</p> <p>With full telescopic pullout Load capacity 60 kg</p>		708 mm x 328 mm x 80 mm (effective internal dimensions)	07-4T
<p>Hanging filing system</p> <p>For 2 x DIN A4 suspension files with full telescopic pullout Load capacity 60 kg</p>		780 mm x 380 mm x 70 mm	07-4R
<p>Clothes rack</p> <p>Shelf with an extendable mounted clothes rack</p>		780 mm x 380 mm x 19 mm	07-4S

Office tall cabinet organisation aids

The steel plate drawers used in the office cabinet system are technically of the same construction as the laboratory system. The consistent organisation system also ensures optimum tidiness here - whether for base cabinets, side cabinets or tall cabinet drawers. If partitions and compartment dividers are used in the wide drawer, 1 set of perforated grid strips are required per drawer.

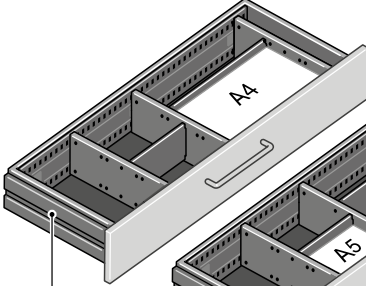
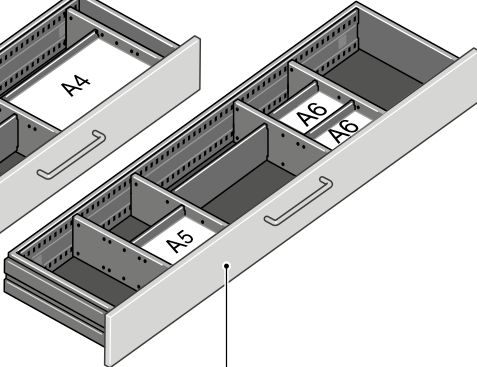
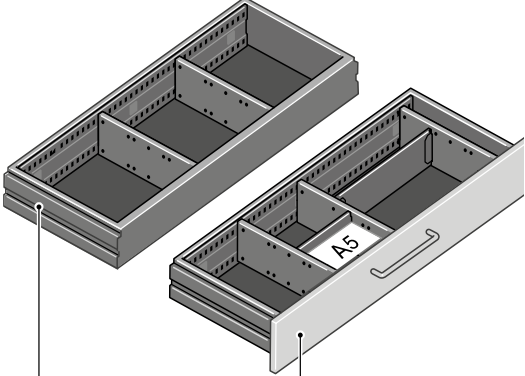
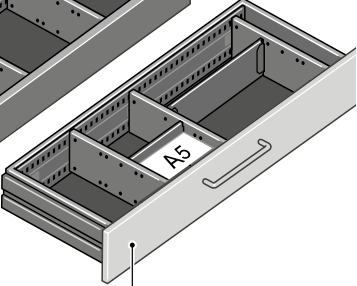
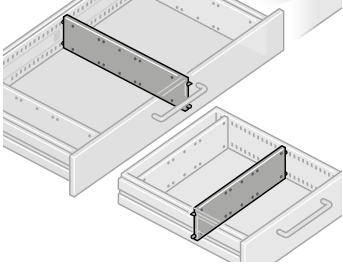
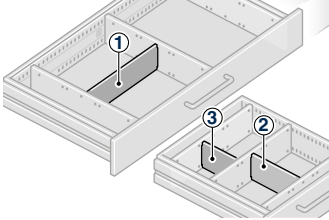
Technical Data

Description	Order-no.		
<div style="display: flex; justify-content: space-around;"> <div style="text-align: center;">  <p>Wide steel plate drawer With panel Internal dimensions: D = 326 mm W = 708 mm for side cabinets, width 820 mm</p> </div> <div style="text-align: center;">  <p>Wide steel plate drawer With panel Internal dimensions: T = 326 mm W = 1090 mm For side cabinets, width 1200 mm</p> </div> <div style="text-align: center;">  <p>Wide steel plate drawer Inside Internal dimensions: D = 326 mm W = 690 mm For tall cabinets, width 820 mm</p> </div> <div style="text-align: center;">  <p>Wide steel plate drawer With panel Internal dimensions: D = 326 mm W = 690 mm For tall cabinets, width 820 mm</p> </div> </div>			
<p>Partitions</p> <p>Black metal</p>		<p>326 mm x 10 mm x 75 mm</p>	<p>07-7A</p>
<p>Compartment divider</p> <p>(1) Compartment divider A4 black metal (2) Compartment divider A5 black metal (3) Compartment divider A6 black metal</p>		<p>310 mm x 1 mm x 72 mm 210 mm x 1 mm x 72 mm 150 mm x 1 mm x 72 mm</p>	<p>07-7C 07-7D 07-7E</p>
<p>Perforated grid strips</p> <p>1 pair of strips (front / rear) metal black</p> <p>for wide drawers with inside width 690 mm Inner width 1090 mm Required for the use of partitions and dividers in wide drawers.</p>		<p>689 mm x 4 mm x 84 mm 1089 mm x 4 mm x 84 mm</p>	<p>07-7F 07-7H</p>

Office side cabinets

Technical Data

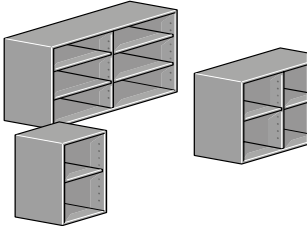
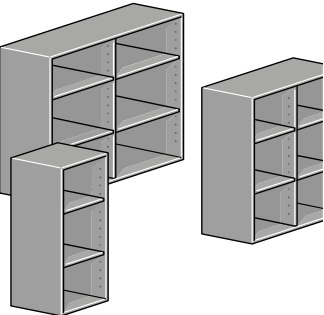
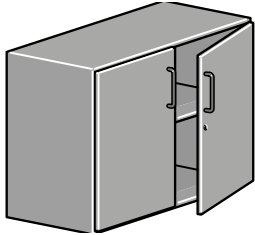
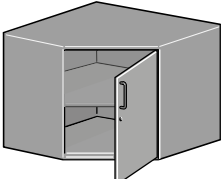
Description			Order-No.
<p>Side shelf</p> <p>1 shelf Centre wall</p> <p>2 shelves Centre wall</p> <p>2 shelves</p>		<p>420 mm x 440 mm x 720 mm</p> <p>820 mm x 440 mm x 720 mm</p> <p>1200 mm x 440 mm x 720 mm</p>	<p>09-2A</p> <p>09-2B</p> <p>09-2C</p>
<p>Side shelf</p> <p>2 shelves</p> <p>1 centre wall 4 shelves</p> <p>1 centre wall 4 shelves</p>		<p>420 mm x 440 mm x 1100 mm</p> <p>820 mm x 440 mm x 1100 mm</p> <p>1200 mm x 440 mm x 1100 mm</p>	<p>09-3A</p> <p>09-3B</p> <p>09-3C</p>
<p>Side cabinet</p> <p>2 folding doors 1 centre wall 2 shelves</p>		<p>820 mm x 440 mm x 720 mm</p>	<p>09-2D</p>
<p>Corner side cabinet</p> <p>1 folding door right 1 height-adjustable shelf, 19 mm stark</p> <p>Base</p>		<p>765 mm x 440 mm x 720 mm</p> <p>765 mm x 440 mm x 30 mm</p> <p>765 mm x 440 mm x 80 mm</p>	<p>09-2P</p> <p>09-4U</p> <p>09-4V</p>

Office side cabinets

Technical Data

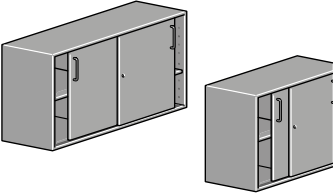
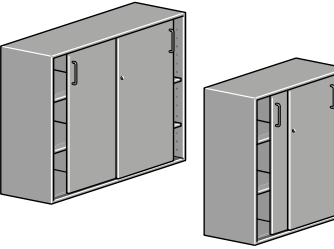
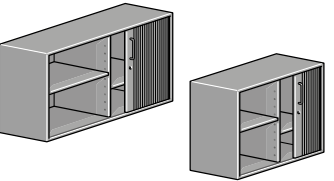
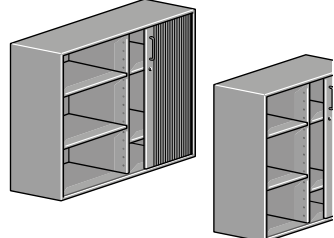
Description			Order-no.
<p>Side cabinet</p> <p>With sliding doors, centre wall 2 shelves</p> <p>With sliding doors, centre wall 2 shelves</p>		<p>820 mm x 440 mm x 720 mm</p> <p>1200 mm x 440 mm x 720 mm</p>	<p>09-2E</p> <p>09-2F</p>
<p>Side cabinet</p> <p>With sliding doors, centre wall 4 shelves</p> <p>With sliding doors, centre wall 4 shelves</p>		<p>820 mm x 440 mm x 1100 mm</p> <p>1200 mm x 440 mm x 1100 mm</p>	<p>09-3E</p> <p>09-3F</p>
<p>Side cabinet</p> <p>With transverse roller shutters, centre wall 2 shelves</p> <p>With transverse roller shutters, centre wall 2 shelves</p>		<p>820 mm x 440 mm x 720 mm</p> <p>1200 mm x 440 mm x 720 mm</p>	<p>09-2G</p> <p>09-2H</p>
<p>Side cabinet</p> <p>With transverse roller shutters, centre wall 4 shelves</p> <p>With transverse roller shutters, centre wall 4 shelves</p>		<p>820 mm x 440 mm x 1100 mm</p> <p>1200 mm x 440 mm x 1100 mm</p>	<p>09-3G</p> <p>09-3H</p>

Office side cabinets

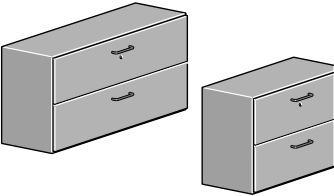
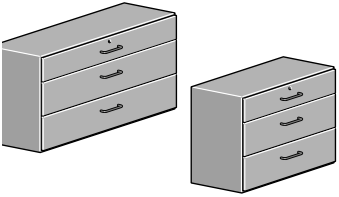
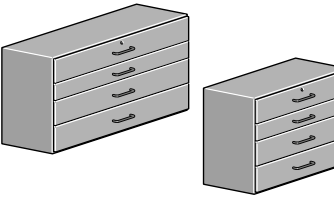
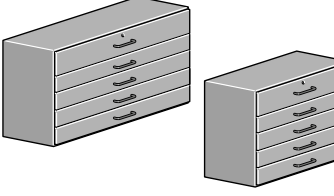

As it is the case with laboratory use, the office side cabinets with drawers are equipped with steel plate drawers and full telescopic

Technical Data

Description			Order-No.
<p>Side cabinet</p> <p>With hanging filing system 2x 2 x A4 crosswise</p> <p>With hanging filing system 2x 3 x A4 crosswise</p>		<p>820 mm x 440 mm x 720 mm</p> <p>1200 mm x 440 mm x 720 mm</p>	<p>09-2J</p> <p>09-2K</p>
<p>Side cabinet</p> <p>With 3 drawers 3 + 4 + 4 HU</p>		<p>820 mm x 440 mm x 720 mm</p> <p>1200 mm x 440 mm x 720 mm</p>	<p>09-2R</p> <p>09-2U</p>
<p>Side cabinet</p> <p>With 4 drawers 3 + 2 + 3 + 3 HU</p>		<p>820 mm x 440 mm x 720 mm</p> <p>1200 mm x 440 mm x 720 mm</p>	<p>09-2S</p> <p>09-2V</p>
<p>Side cabinet</p> <p>With 5 drawers 3 + 2 + 2 + 2 + 2 HU</p>		<p>820 mm x 440 mm x 720 mm</p> <p>1200 mm x 440 mm x 720 mm</p>	<p>09-2T</p> <p>09-2W</p>

Office side cabinet accessories

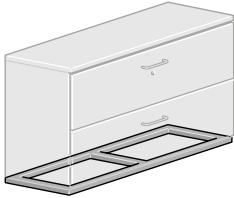
Technical Data

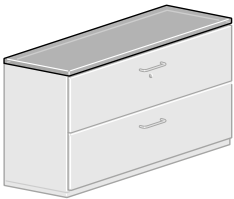
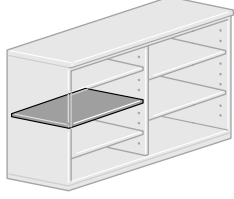
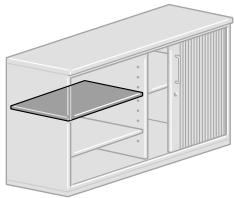
Description			Order-no.
<p>Base</p> <p>For side cabinets W = 420 mm For side cabinets W = 820 mm For side cabinets W = 1200 mm</p> <p>For side cabinets W = 420 mm For side cabinets W = 820 mm For side cabinets W = 1200 mm</p>		<p>420 mm x 440 mm x 30 mm 820 mm x 440 mm x 30 mm 1200 mm x 440 mm x 30 mm</p> <p>420 mm x 440 mm x 80 mm 820 mm x 440 mm x 80 mm 1200 mm x 440 mm x 80 mm</p>	<p>09-4A 09-4B 09-4C</p> <p>09-4R 09-4S 09-4T</p>
<p>Storage tray</p> <p>1 fold</p> <p>2 fold</p>		<p>420 mm x 440 mm x 19mm 820 mm x 440 mm x 19 mm</p> <p>1200 mm x 440 mm x 19 mm</p>	<p>09-4E 09-4F</p> <p>09-4G</p>
<p>Cover plate</p> <p>For side cabinets W = 420 mm For side cabinets W = 820 mm For side cabinets W = 1200 mm</p> <p>For corner side cabinet As an alternative, one-piece cover plates can be laid over several side cabinets</p>		<p>426 mm x 450 mm x 30 mm 826 mm x 450 mm x 30 mm 1206 mm x 450 mm x 30 mm</p> <p>771 mm x 450 mm x 30 mm</p>	<p>09-4K 09-4L 09-4M</p> <p>09-4X</p>
<p>Additional shelf</p> <p>For side cabinets W = 420/820 mm For side cabinets W = 1200 mm</p> <p>For side cabinet 09-2D</p>		<p>380 mm x 360 mm x 19 mm 570 mm x 360 mm x 19 mm</p> <p>380 mm x 380 mm x 19 mm</p>	<p>09-5A 09-5C</p> <p>09-5E</p>
<p>Additional shelf</p> <p>For roller shutter cabinets W = 820 mm For roller shutter cabinets W = 1200 mm</p>		<p>340 mm x 330 mm x 19 mm 530 mm x 330 mm x 19 mm</p>	<p>09-5B 09-5D</p>

Office side cabinet accessories

The rear walls on the partitions can be used for internal information purposes in the same way as in the laboratory area. Mounting a pinboard or a steel plate surface for writing on provides an expedient method of communication. Pinboard design and powder coated steel plate in white. Simple installation using double-sided tape.

Technical Data

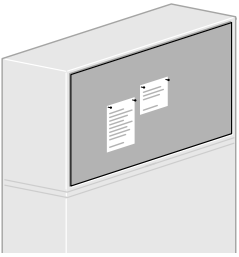
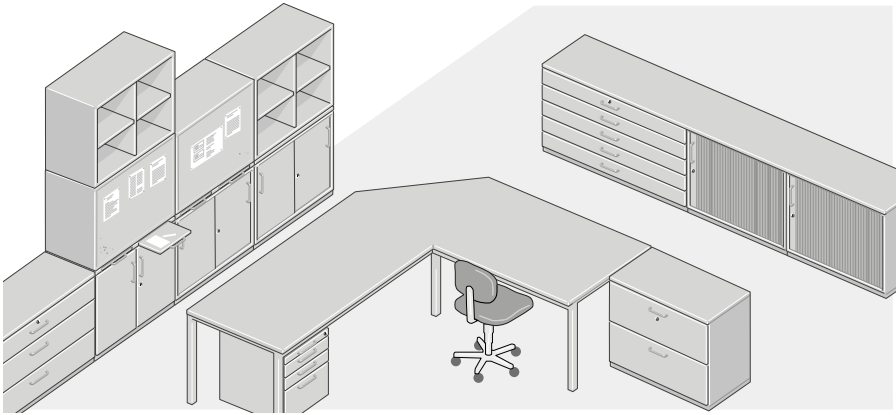
Description			Order-No.
<p>Pinboard</p> <p>For cabinet dimension For cabinet dimension For cabinet dimension</p> <p>For cabinet dimension For cabinet dimension</p>		<p>420 mm x 720 mm 820 mm x 720 mm 1200 mm x 720 mm</p> <p>820 mm x 1100 mm 1200 mm x 1100 mm</p>	<p>09-7A 09-7B 09-7C</p> <p>09-8B 09-8C</p>
<p>Placement variants Partition elements</p>			

L 19" Cabinets



19" Cabinets



19" base cabinets



Technical features

19" fixed or mobile base cabinets and cabinets matching the InForm system tables can be combined into complete functional groups under tables, as side tables or as free-standing components for optimum use.

Max. permitted total weight 180 kg. Lid and bottom parts are made of cast aluminium. The 4 aluminium grid profiles allows you to install 19" components acc. DIN 41494.



The side walls and the rear wall are made of 1.5 mm steel plate. The 19" side cabinets are covered with a 30 mm-thick tabletop with a postformed edge.

For 19" built-in components, see the Elabo Electronics Order Catalogue or the Elabo Device Catalogue TestSystems; system wiring on request. Keyboard pullouts and support rails are available for 19" base cabinets and cabinets.

The 19" cabinets can be retrofitted to mobile units using the robust die-cast aluminium stand.

19" base cabinets

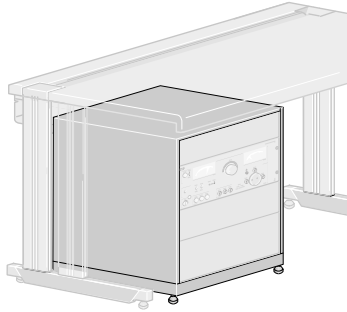
Technical Data

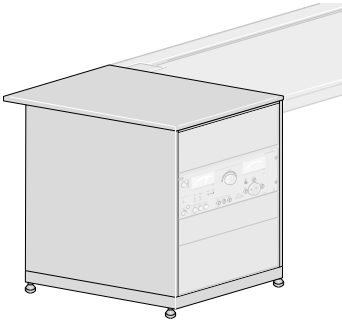
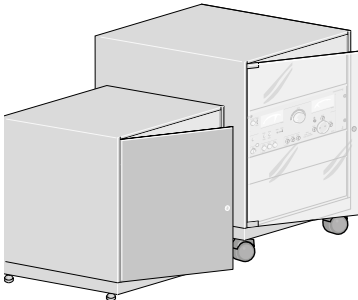
Description		Order-no.
<p>Base cabinet 19" / 12HU</p> <p>Aluminium basic construction, side and rear walls made of steel plate, upper cover plate with 30 mm postformed edge. Colour: light grey</p> <p>Under 800/900 mm-deep tables W = 553 mm x D = 600 mm x H = 670 mm</p> <p>Under 1000 mm-deep tables W = 553 mm x D = 800 mm x H = 670 mm</p>		<p>73-1A</p> <p>73-2A</p>
<p>Side cabinet, mobile 19" / 12HU</p> <p>as with 73-1A/2A, but with 4 swivel castors 75 mm in diameter, Cover pate with tabletop depth</p> <p>Next to 800 mm deep tables W =553 mm x D =600 mm x H = 750 mm</p> <p>Next to 900 mm deep tables W =553 mm x D =600 mm x H = 750 mm</p> <p>Next to 1000 mm deep tables W =553 mm x D =800 mm x H = 750 mm</p>		<p>73-1B</p> <p>73-1D</p> <p>73-2B</p>
<p>Side cabinet 19" / 14HU</p> <p>as with 73-1A/2A,Cover plate with tabletop depth</p> <p>Next to 800 mm deep tables W =553 mm x D =600 mm x H = 750 mm</p> <p>Next to 900 mm deep tables W =553 mm x D =600 mm x H = 750 mm</p> <p>Next to 1000 mm deep tables W =553 mm x D =800 mm x H = 750 mm</p>		<p>73-1C</p> <p>73-1E</p> <p>73-2C</p>
<p>Doors 12HU / 14HU lockable</p> <p>Steel plate door, 1.5 mm thick, powder coated in light grey</p> <p>for 12HU cabinet left, 19" / 12HU for 12HU cabinet right, 19" / 12HU for 14HU cabinet left, 19" / 14HU for 14HU cabinet right, 19" / 14HU</p> <p>Smoked glass door</p> <p>for 12HU cabinet left, 19" / 12HU for 12HU cabinet right, 19" / 12HU for 14HU cabinet left, 19" / 14HU for 14HU cabinet right, 19" / 14HU</p>		<p>73-3A</p> <p>73-3B</p> <p>73-3C</p> <p>73-3D</p> <p>73-3L</p> <p>73-3M</p> <p>73-3N</p> <p>73-3P</p>

19" cabinets

Technical Data

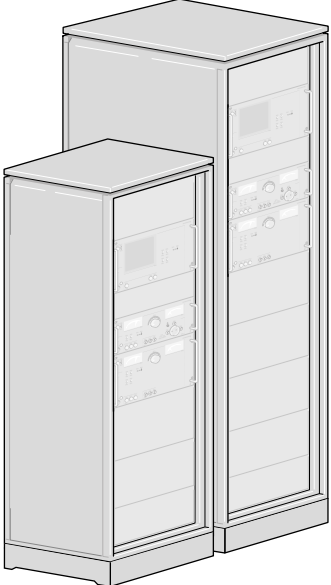
Description		Order-no.
<p>19" Mini-Rack 25HU</p> <p>Design as for 19" base cabinets, but upper housing finish made of steel plate. Colour: light grey.</p> <p>W = 553 mm x D = 600 mm x H = 1253 mm W = 553 mm x D = 780 mm x H = 1253 mm</p> <p>Steel door with lock for 19" mini-rack left, 19" / 25HU for 19" mini-rack right, 19" / 25HU</p> <p>Smoked glass door with lock for 19" rack left, 19" / 25HU for 19" rack right, 19" / 25HU</p>		<p>73-1F 73-2F</p> <p>73-3E 73-3F</p> <p>73-3Q 73-3R</p>
<p>19" Euro-Rack 34HU / 43HU</p> <p>Design as for 73-1F, but with reinforced aluminium basic construction for floor, lid and grid vertical profiles. Door in steel rear wall.</p> <p>19" Euro-Rack 34HU W = 600 mm x D = 600 mm x H = 1737 mm W = 600 mm x D = 800 mm x H = 1737 mm</p> <p>19" Euro-Rack 43HU W = 600 mm x D = 600 mm x H = 2137 mm W = 600 mm x D = 800 mm x H = 2137 mm</p> <p>Steel door with lock for 19" Euro rack left, 19" / 34HU for 19" Euro rack right, 19" / 34HU for 19" Euro rack left, 19" / 43HU for 19" Euro rack right, 19" / 43HU</p> <p>Smoked glass door with lock for 19" Euro rack left, 19" / 34HU for 19" Euro rack right, 19" / 34HU for 19" Euro rack left, 19" / 43HU for 19" Euro rack right, 19" / 43HU</p>		<p>73-1G 73-2G</p> <p>73-1J 73-2J</p> <p>73-3G 73-3H 73-3J 73-3K</p> <p>73-3T 73-3U 73-3V 73-3W</p>

Accessories 19" cabinets

Technical Data

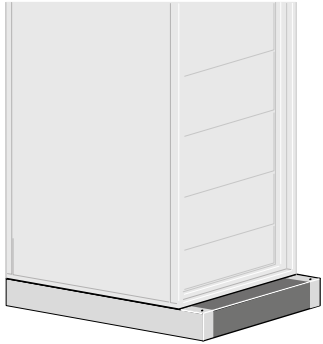
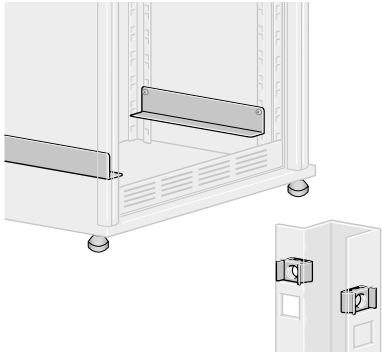
Description		Order-no.
<p>19" Keyboard pullout</p> <p>1 HU, with device handle, fits e.g. Cherry keyboards with touch pad.</p>		<p>73-4A</p>
<p>Plinth for 19" Racks</p> <p>Made of sturdy die-cast aluminium</p> <p>Mobile with stoppers,</p> <p>Fits with 19" Euro racks with a cabinet depth of 600 and 800 mm</p> <p>W = 602 mm x D = 890 mm x H = 117 mm</p> <p>Fits with 19"-mini-Racks</p> <p>For cabinet depth 600 mm</p> <p>W = 546 mm x D = 693 mm x H = 81 mm</p> <p>For cabinet depth 800 mm</p> <p>W = 546 mm x D = 872 mm x H = 81 mm</p>		<p>73-4E</p> <p>73-4E ZMR600</p> <p>73-4E ZMR800</p>
<p>Guide rails</p> <p>Made of steel plate yellow chromated</p> <p>Fits with 19" base cabinets</p> <p>19" mini racks</p> <p>For cabinet depth 600 mm</p> <p>W = 36 mm x D = 468 mm x H = 50 mm</p> <p>For cabinet depth 800 mm</p> <p>W = 36 mm x D = 647 mm x H = 50 mm</p> <p>Fits with 19" Euro racks</p> <p>For cabinet depth 600 mm</p> <p>W = 36 mm x D = 417 mm x H = 50 mm</p> <p>For cabinet depth 800 mm</p> <p>W = 36 mm x D = 417 mm x H = 50 mm</p> <p>Cage nut M6 (1 piece) for 19" grid profile</p> <p>W = 14 mm x D = 9 mm x H = 13 mm</p>		<p>73-4K</p> <p>73-4L</p> <p>73-4K Z01</p> <p>73-4L Z01</p> <p>73-4P</p>



M Education



M1

primus one

System table with cable flap and cable duct



Edge strip



F- edging

Technical features

- Rear table legs as system profile column with integrated cable duct
- Heavy-load slot nuts on the table legs for attaching accessories
- Centrally arranged fold-away cable flap
- Large-volume cable trough accessible from the front
- When set up side by side the cabling can be passed straight through
- Height adjusters for leveling on uneven floors
- Optionally available with height adjustment – can also be retrofitted
- Individual colour choice possible
- System profile can be expanded at the back
- Front table legs can be set back to provide more legroom

Note:

Front insert panels must be ordered separately. You can find them in chapter 1.1 Table accessories

primus one

System table with cable flap and cable duct

Technical data

Table top	
Thickness	30 mm
Front edging	Edge strip 3 mm thick or Flexi-Line edging, exchangeable (F-edging)
Coating	HPL laminate 0.8 mm, non-glare, abrasion-resistant in accordance with EN 438, heat-resistant for short periods, highly flame-retardant
Colour	light grey RAL 7035
Cable duct	
Dimensions	Height = 150 mm, Depth = 175 mm
Cable flap	
Configuration	Fold-away, with brush strip on the back
Dimensions	Width = 880 mm, Depth = 124 mm, Height = 30 mm
Maximum load	
Weight loading	200 kg surface load capacity
ESD Variant	
Table top	Same properties as standard model but volume-conductive
Configuration	DIN EN 61340-5-1 Part 5-1
Dimensions	
Width	1200 mm, 1500 mm, 1600 mm, 1800 mm, 2000 mm
Depth	800 mm, 900 mm, 1000 mm
Height	750 mm

Ordering no.

Width x Depth	Clear dimensions between profiles	F - edging	Edge strip
1200 mm x 800 mm	964 mm	K0-1E	K0-1E.S
1500 mm x 800 mm	1264 mm	K0-1D	K0-1D.S
1600 mm x 800 mm	1364 mm	K0-1C	K0-1C.S
1800 mm x 800 mm	1564 mm	K0-1B	K0-1B.S
2000 mm x 800 mm	1764 mm	K0-1A	K0-1A.S
1200 mm x 900 mm	964 mm	K0-2E	K0-2E.S
1500 mm x 900 mm	1264 mm	K0-2D	K0-2D.S
1600 mm x 900 mm	1364 mm	K0-2C	K0-2C.S
1800 mm x 900 mm	1564 mm	K0-2B	K0-2B.S
2000 mm x 900 mm	1764 mm	K0-2A	K0-2A.S
1200 mm x 1000 mm	964 mm	K0-3E	K0-3E.S
1500 mm x 1000 mm	1264 mm	K0-3D	K0-3D.S
1600 mm x 1000 mm	1364 mm	K0-3C	K0-3C.S
1800 mm x 1000 mm	1564 mm	K0-3B	K0-3B.S
2000 mm x 1000 mm	1764 mm	K0-3A	K0-3A.S

primus one

System-Superstructure 3HU



Technical features

- Ergonomically inclined towards the user (front inclination)
- Completely electrically pre-wired with device connections
- Can be fitted with Elabo devices or third-party devices
- Removable metal rear wall



Note:

Table must be ordered separately.

primus one

System-Superstructure 3HU

Technical data

Body		
Thickness	19 mm	
Coating	Melamine coating, resistant to organic solvents, weak acids, gasoline and oil	
Colour	light grey RAL 7035	
Dimensions	Width	Equipment
Width	1200 mm	216HP
	1500 mm	270HP
	1600 mm	294HP
	1800 mm	330HP
	2000 mm	372HP
Depth		Top: 375 mm Bottom: 388 mm
Height	3HU	211 mm

Ordering no.

Width	Standard
1200 mm	K4-2E.X01
1500 mm	K4-2D.X01
1600 mm	K4-2C.X01
1800 mm	K4-2B.X01
2000 mm	K4-2A.X01

Suitable system profile (1 pair)

Length: 210 mm	K5-1P.0210
----------------	------------

primus one

Fold- away system technology 3HU



Technical features

- Fold-away device body to protect devices when not in use
- In retracted state usable as a normal work table
- Device body can be equipped with Elabo or third-party devices
- Electrically prewired with device connections
- Ergonomically and clearly arranged devices
- System profile columns expandable upwards
- Base body with inspection flap
- End position identification combined with software
- Replacable ergonomically front-edge
- Rear table legs usable for cable routing
- Optionally remotely controllable by switch or software



Scope of delivery

Primus One system table including fold-away system device body and electric drive

Height extender profiles, interchangeable frames, insert panels and devices must be ordered separately.

Note

Insert panels underneath table top have a length of 480 mm.

primus one

Fold- away system technology 3HU

Technical data

Table top	
Thickness	30 mm
Front edge	Flexi-Line edging, exchangeable
Coating	HPL laminate 0.8 mm, non-glare, abrasion-resistant in accordance with EN 438, heat-resistant for short periods
Colour	light grey RAL 7035
Device body	
Thickness	3HU grid system according to DIN 41494 1HP = 5,08 mm
Front edge	19 mm
Coating	Melamine coating, resistant to organic solvents, weak acids, gasoline and oil
Colour	light grey RAL 7035
Dimensions	
Width	1200 mm, 1500 mm, 1600 mm, 1800 mm, 2000 mm
Depth	800 mm, 900 mm
Height	750 mm

Ordering no.

Width x Depth	Mounting width	Ordering no.
1200 mm x 800 mm	3HU / 144HP	A7-4E
1500 mm x 800 mm	3HU / 188HP	A7-4D
1600 mm x 800 mm	3HU / 234HP	A7-4C
1800 mm x 800 mm	3HU / 270HP	A7-4B
2000 mm x 800 mm	3HU / 300HP	A7-4A
1200 mm x 900 mm	3HU / 144HP	A7-5E
1500 mm x 900 mm	3HU / 188HP	A7-5D
1600 mm x 900mm	3HU / 234HP	A7-5C
1800 mm x 900 mm	3HU / 270HP	A7-5B
2000 mm x 900 mm	3HU / 300HP	A7-5A

primus one

System support columns for didactics



Technical features

- Aluminum press rod profile for maximum stability
- Heavy-load slot nuts for attaching accessories, e.g. PC-holder
- High-quality anodized surface
- Profile designed as a "vertical equipping channel"
- Cable clips inside for clear arranged cable routing
- Suitable for equipping system Insert panels
- Expandable upwards by invisible, patented fixing technology (at rear table legs)





Technical data

Description	Length	Ordering- No.
For equipping with 240 mm insert panels	270 mm	K5-1P.0270
For equipping with 480 mm insert panels or 1 x 360 mm + 1 x 120 mm Suitable for fixing of interchangeable frame (1-level)	510 mm	K5-1P.0510
For equipping with 1 x 480 mm + 1 x 360 mm insert panels Suitable for fixing of interchangeable frame (2-level)	870 mm	K5-1P.0870

primus one

System insert panels for didactics



Technical data

Description			Odering- No.
<p>Power supply panel 3-phase</p> <p>System voltage 3 / N / PE ~50 Hz 400 V 16 A</p> <p>W =80 mm, H = 360 mm</p> <p>Equipment: 1 Emergency off switch, unwired 1 Off button 1 Key switch button 3 Phase indicator lights 5 Safety rules</p>		<p>Insert panel traffic red</p> <p>Insert panel signal blue</p> <p>Insert panel black grey</p>	<p>K5-5A00DE.360.3020</p> <p>K5-5A00DE.360.5005</p> <p>K5-5A00DE.360.7021</p>
<p>Didactic panel</p> <p>W =80 mm, H = 360 mm</p> <p>Equipment: 2 Safety lab terminals 2 mm red / black, unwired Print "KNX-Logo" 1 Schuko Socket (type F) 1 Univers-double-socket (RJ45)/8/8(8/8) Cat.6, shielded (unwired)</p>		<p>Insert panel traffic red</p> <p>Insert panel signal blue</p> <p>Insert panel black grey</p>	<p>K5-5A01DE.360.3020</p> <p>K5-5A01DE.360.5005</p> <p>K5-5A01DE.360.7021</p>
<p>Didactic panel</p> <p>W =80 mm, H = 360 mm</p> <p>Equipment: 1 quick connect coupling NW5 1/8" incl. 1 plug nipple NW5 for plastic tube 6/4 1 interface panel "ASi" 4 safety lab terminals 4mm yellow, unwired 1 interface panel "PROFI BUS" 2 sub-D adapter (Genter-Changer) 9-pole front side female / Back side female ? 2 safety lab terminals 4mm black, unwired 1 interface panel "PROFI NET" 2 x RJ45 socket 8-pole, pluggable on both sides incl. 3 m patch cable</p>		<p>Insert panel traffic red</p> <p>Insert panel signal blue</p> <p>Insert panel black grey</p>	<p>K5-5A02DE.360.3020</p> <p>K5-5A02DE.360.5005</p> <p>K5-5A02DE.360.7021</p>
<p>Power supply panel 1-phase with voltage drain</p> <p>System voltage 1 / N / PE ~50 Hz 230 V 16 A</p> <p>W =80 mm, H = 480 mm</p> <p>Special configuration With black key-operated mushroom switch, designed as push-off</p> <p>Equipment: 1 key-operated switch, black 1 phase indicator light 3 Schuko sockets (type F) 3 safety lab terminals</p>		<p>Insert panel traffic red</p> <p>Insert panel signal blue</p> <p>Insert panel black grey</p>	<p>K5-1A13DE.480.3020</p> <p>K5-1A13DE.480.5005</p> <p>K5-1A13DE.480.7021</p>

primus one

System insert panels for didactics



Technical data

Description			Ordering- No.
<p>Power supply panel with Emergency off switch</p> <p>System voltage 3 / N / PE ~50 Hz 400 V 16 A</p> <p>W =80 mm, H = 480 mm</p> <p>Equipment: 5 Safety lab terminals 1 Schuko socket (type F) 1 Emergency off switch, unwired 1 USB Socket 1 RJ45 Cat6 throughput receptacles 1 Cable outlet Ø 60 mm, black</p>		<p>Insert panel traffic red</p> <p>Insert panel signal blue</p> <p>Insert panel black grey</p>	<p>K5-5B00DE.480.3020</p> <p>K5-5B00DE.480.5005</p> <p>K5-5B00DE.480.7021</p>
<p>Power supply panel</p> <p>System voltage 3 / N / PE ~50 Hz 400 V 16 A</p> <p>W =80 mm, H = 480 mm</p> <p>Equipment: 5 Safety lab terminals 2 Schuko sockets (type F) 1 CEE socket</p>		<p>Insert panel traffic red</p> <p>Insert panel signal blue</p> <p>Insert panel black grey</p>	<p>K5-5A02DE.480.3020</p> <p>K5-5A02DE.480.5005</p> <p>K5-5A02DE.480.7021</p>

primus one

System insert panels for didactics



Technical data

Description			Odering- No.
<p>Power supply panel</p> <p>System voltage 3 / N / PE ~50 Hz 400 V 16 A</p> <p>W = 80 mm, H = 480 mm</p> <p>Equipment:</p> <ul style="list-style-type: none"> 1 lighted rocker switch 2 Schuko sockets (type F) 1 Emergency off switch, unwired 1 RJ45 Cat6 throughput socket 1 Switched mode power supply with clocked output voltage 24 V / 6 A Outputs to two safety-type laboratory sockets <p>Voltage display on LED specification:</p> <ul style="list-style-type: none"> Output power: 150 W Residual ripple: 150 mVp-p Output tolerance: $\pm 1.0 \%$ Input control: $\pm 0.5 \%$ Load control: $\pm 0.5 \%$ Overload predection 		<p>Insert panel traffic red</p> <p>Insert panel signal blue</p> <p>Insert panel black grey</p>	<p>K5-5A00DE.480.3020</p> <p>K5-5A00DE.480.5005</p> <p>K5-5A00DE.480.7021</p>
<p>Power supply panel with emergency off switch</p> <p>System voltage 3 / N / PE ~50 Hz 400 V 16 A</p> <p>W =80 mm, H = 480 mm</p> <p>Equipment:</p> <ul style="list-style-type: none"> 5 Safety lab terminals 1 Schuko socket (type F) 1 Emergency off switch, unwired 1 RJ45 Cat6 throughput socket 1 Switch mode power supply with clocked output voltage 24 V / 6 A Outputs guidet on 2 laboratory safety sockets <p>Voltage indicator by LED</p> <p>Spezifications:</p> <ul style="list-style-type: none"> Output power: 150 W Residual ripple: 150 mVp-p Output tolerance: $\pm 1.0 \%$ Input control: $\pm 0.5 \%$ Load control: $\pm 0.5 \%$ Overload predection 		<p>Insert panel traffic red</p> <p>Insert panel signal blue</p> <p>Insert panel black grey</p>	<p>K5-5B01DE.480.3020</p> <p>K5-5B01DE.480.5005</p> <p>K5-5B01DE.480.7021</p>

primus one

System insert panels for didactics



Technical data

Description			Odering- No.
<p>Power supply panel</p> <p>System voltage 3 / N / PE ~50 Hz 400 V 16 A</p> <p>W =80 mm, H = 480 mm</p> <p>Equipment:</p> <ul style="list-style-type: none"> 5 Safety lab terminals 3 Schuko sockets (type F) 1 Quick connect coupling NW 5 1/8" incl. 1 plug nipple NW 5 for plastic tube 6/4 1 Switch mode power supply with clocked output voltage 24 V /6 A Switch mode power supply with clocked output voltage Voltage indicator by LED <p>Spezifications:</p> <ul style="list-style-type: none"> Output power: 150 W Residual ripple: 150 mVp-p Output tolerance: ± 1.0 % Input control: ± 0.5 % Load control: ± 0.5 % Overload predection 		<p>Insert panel traffic red</p> <p>Insert panel signal blue</p> <p>Insert panel black grey</p>	<p>K5-5A01DE.480.3020</p> <p>K5-5A01DE.480.5005</p> <p>K5-5A01DE.480.7021</p>
<p>Power supply panel</p> <p>System voltage 1 / N / PE ~50 Hz 230 V 16 A</p> <p>W =80 mm, H = 120 mm</p> <p>Equipment:</p> <ul style="list-style-type: none"> 1 Quick connect coupling NW 5 1/8" incl. 1 plug nipple NW 5 for plastic tube 6/4 1 Switch mode power supply with clocked output voltage 24 V / 6 A Switch mode power supply with clocked output voltage Voltage indicator by LED <p>Spezifications:</p> <ul style="list-style-type: none"> Output power: 150 W Residual ripple: 150 mVp-p Output tolerance: ± 1.0 % Input control: ± 0.5 % Load control: ± 0.5 % Overload predection 		<p>Insert panel traffic red</p> <p>Insert panel signal blue</p> <p>Insert panel black grey</p>	<p>K5-5A00DE.120.3020</p> <p>K5-5A00DE.120.5005</p> <p>K5-5A00DE.120.7021</p>

primus one

System insert panels for didactics

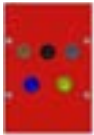

Technical data

Description			Odering- No.
<p>Emergency-off panel</p> <p>W =80 mm, H = 120 mm</p> <p>Equipment: 1 Emergency off switch, unwired</p>		<p>Insert panel traffic red</p> <p>Insert panel signal blue</p> <p>Insert panel black grey</p>	<p>K5-2B00DE.120.3020</p> <p>K5-2B00DE.120.5005</p> <p>K5-2B00DE.120.7021</p>
<p>Data panel</p> <p>W =80 mm, H = 120 mm</p> <p>Equipment: 1 Univers-double-socket (RJ45)/8/8(8/8) Cat.6, shielded (unwired)</p>		<p>Insert panel traffic red</p> <p>Insert panel signal blue</p> <p>Insert panel black grey</p>	<p>K5-7A00DE.120.3020</p> <p>K5-7A00DE.120.5005</p> <p>K5-7A00DE.120.7021</p>
<p>Power supply panel</p> <p>System voltage 1 / N / PE ~50 Hz 230 V 16 A</p> <p>W =80 mm, H = 120 mm</p> <p>Equipment: 1 Illuminated rocker switch 1 Schuko socket (type F)</p>		<p>Insert panel traffic red</p> <p>Insert panel signal blue</p> <p>Insert panel black grey</p>	<p>K5-2A00DE.120.3020</p> <p>K5-2A00DE.120.5005</p> <p>K5-2A00DE.120.7021</p>
<p>Power supply panel</p> <p>System voltage 3 / N / PE ~50 Hz 400 V 16 A</p> <p>W = 80 mm, H = 120 mm</p> <p>Equipment: 5 Safety lab terminals</p>		<p>Insert panel traffic red</p> <p>Insert panel signal blue</p> <p>Insert panel black grey</p>	<p>K5-3A00DE.120.3020</p> <p>K5-3A00DE.120.5005</p> <p>K5-3A00DE.120.7021</p>

primus one

System insert panels for didactics



Technical data

Description			Ordering- No.
<p>Blank panel for closing off the rear profile</p> <p>W =80 mm, H = 523 mm</p>		<p>Insert panel traffic red</p> <p>Insert panel signal blue</p> <p>Insert panel black grey</p>	<p>K5-0L0000.523.3020</p> <p>K5-0L0000.523.5005</p> <p>K5-0L0000.523.7021</p>
<p>Insert panel with cable outlet</p> <p>W =80 mm, H = 523 mm</p> <p>Equipment: Cable outlet Ø 60 mm, black</p>		<p>Insert panel traffic red</p> <p>Insert panel signal blue</p> <p>Insert panel black grey</p>	<p>K5-0L0100.523.3020</p> <p>K5-0L0100.523.5005</p> <p>K5-0L0100.523.7021</p>

primus one





System insert panels for didactics

Technical data

Description			Ordering- No.
<p>Power supply panel</p> <p>System voltage 1 / N / PE ~50 Hz 400 V 16 A</p> <p>W =80 mm, H = 523 mm</p> <p>Equipment: 1 Cable outlet Ø 60 mm, black 1 Univers-double-socket (RJ45)/8/8(8/8) Cat.6, shielded (unwired) 2 Schuko sockets (type F)</p>		<p>Insert panel traffic red</p> <p>Insert panel signal blue</p> <p>Insert panel black grey</p>	<p>K5-2H05DE.523.3020</p> <p>K5-2H05DE.523.5005</p> <p>K5-2H05DE.523.7021</p>
<p>Power supply panel</p> <p>3/N/PE ~50 Hz 400 V 16 A with CEE socket and Schuko sockets (type F), Cable outlet Ø 60 mm, black</p> <p>W =80 mm, H = 523 mm</p> <p>Equipment: 1 Cable outlet Ø 60 mm, black 1 CEE socket 2 Schuko sockets (type F)</p>		<p>Insert panel traffic red</p> <p>Insert panel signal blue</p> <p>Insert panel black grey</p>	<p>K5-3A01DE.523.3020</p> <p>K5-3A01DE.523.5005</p> <p>K5-3A01DE.523.7021</p>





Cabinets

Technical data

Description			Ordering no.
<p>Complete cabinet with grooved mats</p> <p>2 Folding doors 1 Handle with lock 1 Central wall 2 x 6 adjustable shelves</p> <p>2 x 5 sets of grooved mats for each 5 profiles to store training equipment</p> <p>also available with wireless technology (lockable by transponder)</p>		<p>1020 mm x 600 mm x 2045 mm</p>	<p>07-1W</p>
<p>Complete cabinet with grooved mats</p> <p>2 folding doors, glazed the entire height of the door 4 Shelves, one side with grooved mat 8 Shelves both sides with grooved mat in 2 x 5 levels for DIN A4-Size</p>		<p>1020 mm x 600 mm x 2045 mm</p>	<p>07-1W Z01</p>
<p>Tray cabinet for experiment boxes</p> <p>Basic element with 2-folding doors, handle with integrated safety lock.</p> <p>Attachment element with 2-leaf doors, handle with integrated safety lock</p> <p>Interior side walls with guide grooves to hold storage trays (2 pcs stowed successively)</p>		<p>774 mm x 680 mm x 2045 mm</p> <p>755 mm x 680 mm x 2045 mm</p>	<p>67-1A</p> <p>67-1B</p>
<p>Floor unit with section trays</p> <p>Leaf doors on right or left with safety lock. Body inside with guide grooves on right and left.</p> <p>For the storage of a maximum of 10 polystyrene moulded trays (experiment boxes, tools, installation material etc.)</p>		<p>370 mm x 680 mm x table depth</p> <p>Leaf doors right For table depth 800/850 mm For table depth 900/950 mm For table depth 1000/1050 mm</p> <p>Leaf doors left For table depth 800/850 mm For table depth 900/950 mm For table depth 1000/1050 mm</p>	<p>67-1D X01 67-1D X02 67-1D X03</p> <p>67-1E X01 67-1E X02 67-1E X03</p>





Accessories

Technical data

Description			Ordering no.
<p>Storage Cabinet mobile</p> <p>Special design:</p> <ul style="list-style-type: none"> - Prepared to hold 2x 12 pcs. interchangeable perforated sheet walls type K7-5X.B760 in 2 tiers one above the other - Guides made of multiplex - back wall 19 mm thick - lockable doors - stable mobile metal frame with 4 swivel castors Ø125 mm, two of them lockable. 		1018/1052 mm x 840 mm x 1699 mm	A9-6L
<p>Tray insert</p> <p>Section tray insert for the storage of tools (10 profiles)</p>		310 mm x 700 mm x 35 mm	67-2A
<p>Tray insert</p> <p>Section tray insert for the storage of tools (13 profiles)</p>		310 mm x 700 mm x 35 mm	67-2B
<p>Tray insert</p> <p>Section tray insert for the storage of tools (12 profiles)</p>		310 mm x 700 mm x 35 mm	67-2C
<p>Tray insert universal</p> <p>for the storage of measurement equipment, small parts etc. (4 profiles)</p>		310 mm x 700 mm x 35 mm	67-2D





Experimental frame

Technical data

Description			Ordering no.
<p>Experimental frame 1 level free-standing</p> <p>H-section frame 1 level DIN A4, angled backwards at 15°</p>		850 mm x 260 mm x 380 mm	60-1Q
<p>Experimental frame 2 level free-standing with T-feet</p> <p>H-section frame 2 level DIN A4, free-standing with T feet</p>		850 mm x 310 mm x 700 mm	60-1R
<p>H-Profil frame 1 level for mounting on superstructure</p> <p>2 H-profiles L1900 2 H-profiles L1700 2 H-profiles L1500 2 H-profiles L1400 2 H-profiles L1100</p>		1960 mm x 250 mm x 365 mm 1760 mm x 250 mm x 365 mm 1560 mm x 250 mm x 365 mm 1460 mm x 250 mm x 365 mm 1160 mm x 250 mm x 365 mm	60-1A ZB 196 60-1A ZB 176 60-1A ZB 156 60-1B ZB 146 60-1C ZB 116
<p>H-section frame 2 level for mounting on superstructure</p> <p>3 H-profiles L1900 3 H-profiles L1700 3 H-profiles L1500 3 H-profiles L1400 3 H-profiles L1100</p>		1960 mm x 250 mm x 685 mm 1760 mm x 250 mm x 685 mm 1560 mm x 250 mm x 685 mm 1460 mm x 250 mm x 685 mm 1160 mm x 250 mm x 685 mm	60-1D ZB 196 60-1D ZB 176 60-1D ZB 156 60-1E ZB 146 60-1F ZB 116
<p>H-section frame 3 level for mounting on superstructure</p> <p>4 H-profiles L1900 4 H-profiles L1700 4 H-profiles L1500 4 H-profiles L1400 4 H-profiles L1100</p>		1960 mm x 250 mm x 1005 mm 1760 mm x 250 mm x 1005 mm 1560 mm x 250 mm x 1005 mm 1460 mm x 250 mm x 1005 mm 1160 mm x 250 mm x 1005 mm	60-1H ZB 196 60-1H ZB 176 60-1H ZB 156 60-1J ZB 146 60-1K ZB 116

Patchboards, installation cubicles

Technical data

Description			Ordering no.
<p>Installation cubicle for wall mounting</p> <p>Installation cubicle for carrying out practical installation exercises. The installation panels have a mesh of 5 x 10 mm so that the installation materials can be mounted in any way desired. When not in use, the cubicles can simply be folded up and stored with minimum space requirement.</p> <p>The entire cubicle is powder-coated in light grey RAL 7035. Mounting accessories are included for fixing to the wall. The installation cubicle can also be supplied as a free-standing unit.</p>		<p>1200 mm x 1000 mm x 2000 mm</p>	<p>60-5B ZX01</p>
<p>Mounting accessories</p> <p>Set 1 consisting of: 100 plugs 5 mm x 5 mm, 50 Spax screws 3,5 mm x 12 mm 30 Spax screws 3,5 mm x 20 mm 20 Spax screws 3,5 mm x 30 mm</p> <p>Set 2 consisting of 100 plugs 5 mm x 10 mm, 50 Spax screws 3,5 mm x 12 mm 30 Spax screws 3,5 mm x 20 mm 20 Spax screws 3,5 mm x 30 mm</p>			<p>65-2D</p> <p>65-2E</p>
<p>Slides for experimental frames Primus One and Primus Basic</p>			<p>60-6A</p>
<p>Clip-in perforated panel</p> <p>2x A4 suitable for hooking in experimental frames and Patchboards.</p> <p>W=766mm, H=687mm, D=45mm</p> <p>Configuration: - Perforated panel with perforation of 5 mm x 10 mm - left/right each 32 receptions for safety - with earthing socket</p>			<p>K7-5X</p>

Experimental frame accessories

3 HU Superstructure



Technical data

Description			Ordering no.
<p>Special plugs</p> <p>Special plastic plugs 5 mm x 5 mm 100 per pack</p> <p>Special plastic plugs 5 x 10 mm, 100 per pack</p>			<p>65-2F</p> <p>65-2G</p>
<p>Spax screws</p> <p>3,5 mm x 12 mm 100 per pack</p> <p>3,5 mm x 20 mm 100 per pack</p> <p>3,5 mm x 30 mm 100 per pack</p>			<p>65-2H</p> <p>65-2J</p> <p>65-2K</p>
<p>Brush strips</p> <p>Brush strips for inserting into H-profiles for sound insulation during exercises with experimental boards. Each H-section requires two brush strips per level. (price per metre)</p>		<p>Please specify required length or experimental frame type.</p>	<p>65-2R</p>
<p>3 HU table superstructure for mounting on table</p> <p>Table superstructure with straight front. The table superstructure is designed to accept Elabo cassettes 3 HU in a 5.08 mm division grid. Third-party products can also be integrated. The body is made of 19 mm thick three-ply particle board.</p> <p>For accepting 384 HP For accepting 342 HP For accepting 304 HP For accepting 282 HP For accepting 222 HP</p>		<p>2000 mm x 320 mm x 171 mm 1800 mm x 320 mm x 171 mm 1600 mm x 320 mm x 171 mm 1500 mm x 320 mm x 171 mm 1200 mm x 320 mm x 171 mm</p>	<p>R4-2A.X02 R4-2B.X02 R4-2C.X02 R4-2D.X02 R4-2E.X02</p>

3 HU Superstructure

3 HU Lowering technology system

Technical data

Description			Ordering no.
<p>3 HU table superstructure, equippable on both sides, for mounting on table</p> <p>3 HU table superstructure, 2 x 384 HP with straight front. The table superstructure can be equipped on both long sides with 3 HU insert panels in a 5.08 mm division grid. Third party products can also be integrated. The body is made of 19 mm thick three-ply particle board.</p> <p>3 HU table superstructure, 2 x 342 HP 3 HU table superstructure, 2 x 304 HP 3 HU table superstructure, 2 x 282 HP 3 HU table superstructure, 2 x 222 HP</p>		<p>2000 mm x 400 mm x 171 mm</p> <p>1800 mm x 400 mm x 171 mm 1600 mm x 400 mm x 171 mm 1500 mm x 400 mm x 171 mm 1200 mm x 400 mm x 171 mm</p>	<p>R4-2A.X10</p> <p>R4-2B.X10 R4-2C.X10 R4-2D.X10 R4-2E.X10</p>
<p>Lowerable table superstructures 1-level</p> <p>Lowering mechanism, with superstructure that is vertically extended by electric motor drive, and with a safety shut-off strip. For accepting 3 HU Euro inserts. Prepared for addition of an EcoTecSP or InForm system table. Height of superstructure body in raised state: 1000 mm</p> <p>For accepting 360HP For accepting 318HP For accepting 282HP For accepting 258HP For accepting 198HP</p>		<p>2000 mm x 432 mm x 780 mm 1800 mm x 432 mm x 780 mm 1600 mm x 432 mm x 780 mm 1500 mm x 432 mm x 780 mm 1200 mm x 432 mm x 780 mm</p>	<p>A4-1A.K A4-1B.K A4-1C.K A4-1D.K A4-1E.K</p>
<p>Lowerable table superstructures 2-level</p> <p>Lowering mechanism, with superstructure that is vertically extended by electric motor drive, and with a safety shut-off strip.</p> <p>1st level: For accepting 3HU Euro inserts.</p> <p>2nd level: Shelf element with central wall and shelf panels. Prepared for addition of an EcoTecSP or InForm system table. Height of superstructure body in raised state: 1st level: 1000 mm 2nd level: 1340 mm</p> <p>For accepting 360HP For accepting 318HP For accepting 282HP For accepting 258HP For accepting 198HP</p>		<p>2000 mm x 432 mm x 780 mm 1800 mm x 432 mm x 780 mm 1600 mm x 432 mm x 780 mm 1500 mm x 432 mm x 780 mm 1200 mm x 432 mm x 780 mm</p>	<p>A4-2A.K A4-2B.K A4-2C.K A4-2D.K A4-2E.K</p>

6 HU Lowering technology system

Add-on tables



Technical data

Description			Ordering no.
<p>Lowerable table superstructures 1-level</p> <p>Lowering mechanism, with superstructure that is vertically extended by electric motor drive, and with a safety shut-off strip. For accepting 6 HU Euro inserts. Prepared for addition of an EcoTecSP or InForm system table. Height of superstructure body in raised state: 1135 mm</p> <p>For accepting 360 HP For accepting 324 HP For accepting 282 HP For accepting 264 HP For accepting 204 HP</p>		<p>2000 mm x 432 mm x 780 mm 1800 mm x 432 mm x 780 mm 1600 mm x 432 mm x 780 mm 1500 mm x 432 mm x 780 mm 1200 mm x 432 mm x 780 mm</p>	<p>A5-1A.K A5-1B.K A5-1C.K A5-1D.K A5-1E.K</p>
<p>Lowerable table superstructures 2-level</p> <p>Lowering mechanism, with superstructure that is vertically extended by electric motor drive, and with a safety shut-off strip.</p> <p>1st level: For accepting System 6 HU inserts 2nd level: Shelf element with central wall and shelf panels. Prepared for addition of an EcoTecSP or InForm system table. Height of superstructure body in raised state:</p> <p>1st level: 1135 mm 2nd level: 1340 mm</p> <p>For accepting 360 HP For accepting 324 HP For accepting 282 HP For accepting 264 HP For accepting 204 HP</p>		<p>2000 mm x 432 mm x 780 mm 1800 mm x 432 mm x 780 mm 1600 mm x 432 mm x 780 mm 1500 mm x 432 mm x 780 mm 1200 mm x 432 mm x 780 mm</p>	<p>A5-2A.K A5-2B.K A5-2C.K A5-2D.K A5-2E.K</p>
<p>Add-on tables for lowering technology for 3HU and 6HU System</p> <p>EcoTecSP add-on table prepared for connecting to lowering mechanism types of the A4... and A5... series. Table frame with welded steel tube apron frame and screwattached steel tube table legs 50 mm x 50 mm. Table top 30 mm thick, with replaceable front edge.</p>		<p>2000 mm x 668 mm x 780 mm 1800 mm x 668 mm x 780 mm 1600 mm x 668 mm x 780 mm 1500 mm x 668 mm x 780 mm 1200 mm x 668 mm x 780 mm</p>	<p>A2-1A A2-1B A2-1C A2-1D A2-1E</p>

Lowering technology system / TFT



Add-on tables

Technical data

Description			Ordering no.
<p>Lowering unit for IT training</p> <p>Lowering mechanism with electric motordriven vertically raisable and lowerable TFT monitor brackets and storage areas for mouse and keyboard.</p> <p>Floor-mounted wooden body 19 mm thick with automatically actuated covering flap. Controlled via cable remote control, attached to the unit. Monitor mounted with VESA adaptation 75 x 75 mm or 100 x 100 mm for TFT sizes up to 19 inches, with a maximum depth of 80 mm.</p> <p>Body of unit has integrated cable admission inlet for routing of cables.</p> <p>Student versions: Lowering system body for 2 TFT monitors Lowering system body for 2 TFT monitors Lowering system body for 1 TFT monitor</p> <p>Teacher versions: Lowering system body for 2 TFT monitors Monitor positioning optional left, centre, right</p>		<p>2000 mm x 170 mm x 750 mm</p> <p>1800 mm x 170 mm x 750 mm</p> <p>900 mm x 170 mm x 750 mm</p> <p>1800 mm x 170 mm x 750 mm</p>	<p>A8-1A</p> <p>A8-1B</p> <p>A8-1F</p> <p>A8-1BZ</p>
<p>Add-on tables for TFT unit</p> <p>EcoTecSP add-on table prepared for connecting to lowering mechanism types with TFT monitor brackets.</p> <p>Table frame with welded steel tube apron frame and screw-attached steel tube table legs 50 x 50 mm.</p> <p>Table top 30 mm thick with replaceable front edge.</p>		<p>2000 mm x 630 mm x 750 mm</p> <p>1800 mm x 630 mm x 750 mm</p> <p>900 mm x 630 mm x 750 mm</p>	<p>A1-2A</p> <p>A1-2B</p> <p>A1-2F</p>



Classroom power supply

Technical data

Description			Ordering no.
<p>Floor unit Classroom power supply</p> <p>Floor unit prepared for accepting the 19" / 14 HU grid system. With front leaf doors shortened at the top, right-hung, with lock. The floor unit is divided in depth by a central panel. The rear compartment is used as connecting space for the cables and wires which are wired to terminal blocks. Access via leaf door in left side wall, lockable.</p>		525 mm x 750 mm x 710 mm	A7-8C
<p>Floor unit Classroom power supply</p> <p>Floor unit prepared for accepting the 19" / 14 HU grid system. With front leaf doors shortened at the top, left-hung, with lock. The floor unit is divided in depth by a central panel. The rear compartment is used as connecting space for the cables and wires which are wired to terminal blocks. Access via leaf door in right side wall, lockable.</p>		525 mm x 750 mm x 710 mm	A7-8D
<p>Floor unit Classroom power supply</p> <p>Floor unit prepared for accepting the 19" / 13 HU grid system. With front leaf doors shortened at the top, right-hung, with lock. The floor unit is divided in depth by a central panel. The rear compartment is used as connecting space for the cables and wires which are wired onto terminal blocks. Access via leaf door in left side wall, lockable.</p>		525 mm x 620 mm x 680 mm 525 mm x 720 mm x 680 mm 525 mm x 820 mm x 680 mm	A7-8F A7-8G A7-8H

Insert panels 19"





Technical data

Description			Ordering no.
<p>Main power supply unit</p> <p>19" / 4 HU insert panel, main power supply unit usable for 1/N/PE ~ 50 Hz 230 V or 3/N/PE ~ 50 Hz 230/400 V 45...63 A. For switching on and protecting the classroom power supply. Wiring via block terminals. Equipment:</p> <ul style="list-style-type: none"> 1 FI residual current circuit breaker 4p63A selective, Rated leakage current <= 300 mA, 1 motor predection switch 45...63 A with undervoltage release, 1 key switch I/O, 1 automatic circuit breaker 1p6AB, 1 emergency-OFF switch (acting on the motor predection switch) <p>3-phase indicator lights.</p>		<p>483 mm x 177 mm</p>	<p>68-1K</p>
<p>Main power supply unit</p> <p>19" / 4 HU insert panel, main power supply unit usable for 1/N/PE ~ 50 Hz 230 V or 3/N/PE ~ 50 Hz 230/400 V 45...63 A. For switching on and predecting the classroom power supply. Wiring via block terminals. Equipment:</p> <ul style="list-style-type: none"> 1 FI residual current circuit breaker 4p63A selective, Type B, AC/DC sensitive for smooth DC fault currents <= 300 mA, 1 motor predection switch 45...63 A with undervoltage release, 1 key switch I/O, 1 automatic circuit breaker p6AB, 1 emergency-off switch (acting on the motor predection switch) <p>3-phase indicator lights.</p>		<p>483 mm x 177 mm</p>	<p>68-1K Z008</p>
<p>Circuit predection unit Alternating current</p> <p>19" / 4 HU insert panel Circuit predection unit for 1-pole power supply to student's table. With cut-out and lettering to accept a maximum of 21 x 1-pole automatic circuit breakers. Empty spaces are provided with covers. The panel is pre-wired to terminal blocks.</p>		<p>483 mm x 177 mm</p> <p>Z = Please state the number of automatic circuit breakers required.</p>	<p>68-1L Z1..</p>

Insert panels 19"



Lowering mechanism controls

Technical data

Description			Ordering no.
<p>Circuit pretection unit 3-phase current</p> <p>19" / 8 HU insert panel circuit pretection unit for 3-pole power supply to student's table. With cut-out and lettering to accept a maximum of 21 x 3-pole automatic circuit breakers. Empty spaces are provided with covers. The panel is pre-wired to terminal blocks.</p>		<p>483 mm x 354,8 mm</p> <p>Z = Please state the number of automatic circuit breakers required.</p>	<p>68-1M Z3...</p>
<p>Central up/down control for lowerable superstructures</p> <p>Operating panel with push buttons for up/stop/down control of lowerable superstructures 19" / 2 HU insert panel. Depending on the lowerable superstructures provided, 3 push buttons are installed per table. Using a group function, all lowerable superstructures can be jointly controlled.</p>		<p>483 mm x 88,1 mm</p> <p>Z = Please state the number of operating buttons required for the lowering mechanism.</p>	<p>68-1X Z..</p>
<p>Central up/down control for fold-away mechanism</p> <p>Operating panel with push buttons for up/stop/down control of fold-away superstructures 19" / 2 HU insert panel Depending on the lowerable superstructures provided, 3 push buttons are installed per table. Using a group function, all fold-away superstructures can be jointly controlled.</p>		<p>483 mm x 88,1 mm</p> <p>Z = Please state the number of operating buttons required for the folding mechanism!</p>	<p>68-1X Z4</p>
<p>Local up/down control with key for lowering mechanisms</p> <p>Individual control up/down with key switch on table. Installed in plastic housing.</p> <p>(Not usable for TFT technology)</p>		<p>104 mm x 51 mm x 68 mm</p>	<p>A7-8S</p>

Lowering technology TFT add on tables

Technical data

Description		Ordering no.
<p>Control unit up-down-control</p> <p>of electrical linear drive for Primus One superstructures with swing mechanism. Installed at the front of base body of table.</p>		<p>A7-8S Z601</p>
<p>Blank panels 19"</p> <p>Blank plate 19" / 1HE</p> <p>Blank plate 19" / HE with ventilation slots</p> <p>Blank plate 19" / 2HE</p> <p>Blank plate 19" / 3HE</p> <p>Blank plate 19" / 4HE</p> <p>Blank plate 19" / 6HE</p>		<p>W = 483 mm x H = 43,6 mm 51-1A</p> <p>W = 483 mm x H = 43,6 mm 51-1L</p> <p>W = 483 mm x H = 88,1 mm 51-1B</p> <p>W = 483 mm x H = 132,5 mm 51-1C</p> <p>W = 483 mm x H = 177 mm 51-1E</p> <p>W = 483 mm x H = 266 mm 51-1D</p>

N Storage shelves & Workbenches



Storage shelves & Workbenches

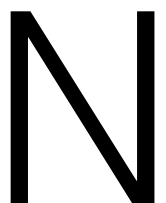

Workbenches



Technical features

To complete the ELABO furnishing systems, we also provide workbenches and organisable steel plate base cabinets. Steel cabinets, shelves and shelf trolleys are available for storage of materials and devices.

Workbench tops: Workbenches are available with various workbench tops depending on the mechanical requirements.

Base cabinets: The steel plate base cabinets are available in three variants:

For suspended or floor installation under the workbench or as a separate individual element cabinet for measuring equipment, tools or material.

The unit is manufactured of 1.25 mm thick quality steel sheeting, all surfaces are powder coated.

The drawers run on ball-bearing pull-out racks, can be pulled out to 90%. Carrying weight 100 kg. Surrounding holes in the bottom and on the side walls enable the use of sectioning elements.





Front side of drawer with handle rail, large labelling area and colour-coded identification. Central locking via security lock, different locks in standard designs.

Base frame

Sturdy steel frame made of 3 transverse-running 40 mm x 40 mm square steel pipes and four longitudinal-running 40 mm x 25 mm rectangular steel pipes, powder coated in light grey (RAL 7035). The removable legs are equipped with height adjusters to compensate for floor unevenness.



Workbenches

Technical data

Description		Order-No.
<p>Table frame Workbench SP</p> <p>welded steel pipe frame made of 40 mm x 40 mm and 40 mm x 25 mm, 4 height-adjustable table legs made of 50 mm x 50 mm square steel pipe, powder coated, conductive</p> <p>Prepared to contain steel plate base cabinets 03-4A...G</p> <p>W = 1990 mm x D = 750 mm x H = 840 mm W = 1490 mm x D = 750 mm x H = 840 mm</p>		<p>E1-0A E1-0B</p>
<p>Multiplex plate</p> <p>made of 40 mm thick, multi-layer adhesive bond workbench plate made of beech veneer</p> <p>Surface ground and painted with clear lacquer</p> <p>W = 2000 mm x D = 800 mm W = 1500 mm x D = 800 mm</p>		<p>E2-0A E2-0B</p>
<p>Beech multiplex plate</p> <p>made of 50 mm thick beech wood, beech wood steamed for enhanced mechanical stress</p> <p>Surface ground and painted with clear lacquer</p> <p>W = 2000 mm x D = 800 mm W = 1500 mm x D = 800 mm</p>		<p>E2-0D E2-0E</p>
<p>Universal plate</p> <p>Universal workbench plate made of 50 mm thick solid-core plate and dual back-pull material for extremely high longitudinal stresses.</p> <p>Surface covered with PVC or linoleum, resistant to oils and fats as well as to heat up to approximately 250 degrees.</p> <p>All edges protected by a 3 mm thick solid timber edge.</p> <p>W = 2000 mm x D = 800 mm W = 1500 mm x D = 800 mm</p>		<p>E2-0G E2-0H</p>
<p>Strengthening strut</p> <p>Made of 30 mm square steel pipe for reinforcement of the table legs under increased load</p> <p>For Table W = 2000 mm x D = 800 mm W = 1500 mm x D = 800 mm</p>		<p>E4-1N E4-1R</p>

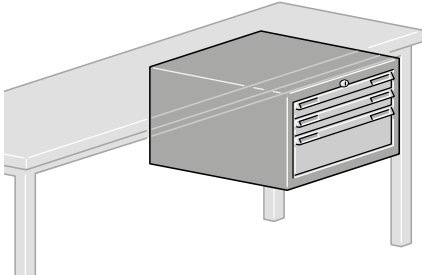
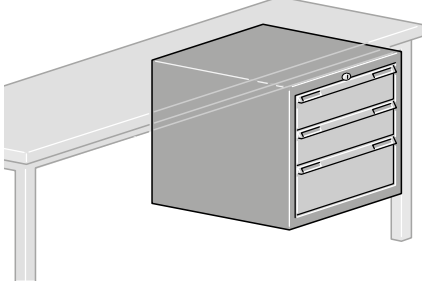
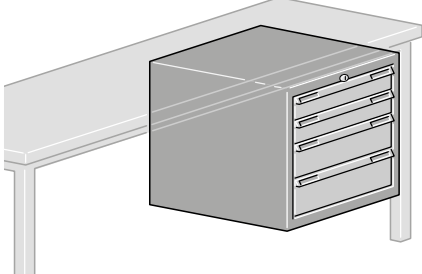

Workbench Accessories

Technical data

Description		Order-No.
<p>Border</p> <p>18 mm thick beech wood plywood strip with rounded edges</p> <p>W = 1500 mm x H = 100 mm W = 2000 mm x H = 100 mm</p>		<p>03-2H 03-2G</p>
<p>Table foot bracket</p> <p>Z angle (2 pcs.) for engaging and fastening EcoTec^{SP} work tables to the floor</p> <p>Colour: black</p>		<p>E4-9G Z01</p>
<p>Base cabinet</p> <p>Made of steel plate</p> <p>2 drawers 75 mm 1 drawer 150 mm</p> <p>W = 605 mm x D = 695 mm x H = 400 mm</p>		<p>03-4A</p>
<p>Base cabinet</p> <p>Made of steel plate</p> <p>2 drawers 150 mm 1 drawer 200 mm</p> <p>W = 605 mm x D = 695 mm x H = 600 mm</p>		<p>03-4C</p>
<p>Base cabinet</p> <p>Made of steel plate</p> <p>2 drawers 100 mm 2 drawers 150 mm</p> <p>W = 605 mm x D = 695 mm x H = 600 mm</p>		<p>03-4D</p>

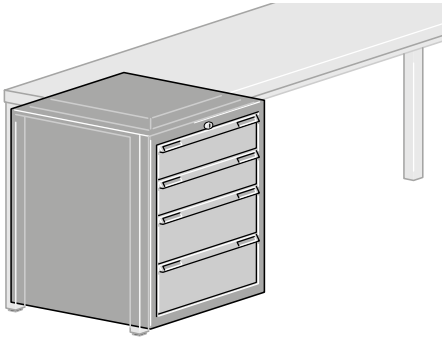
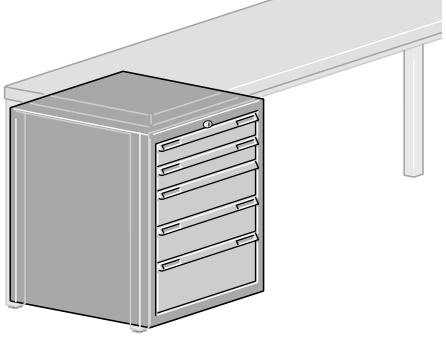
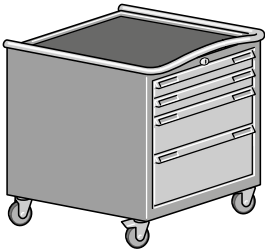

Base cabinet / Rollboy

Technical data

Description		Order-No.
<p>Base cabinet</p> <p>Made of steel plate</p> <p>2 drawers 150 mm</p> <p>2 drawers 200 mm</p> <p>W = 605 mm x D = 695 mm x H = 800 mm</p>		03-4F
<p>Base cabinet</p> <p>Made of steel plate</p> <p>2 drawers 100 mm</p> <p>2 drawers 150 mm</p> <p>1 drawer 200 mm</p> <p>W = 605 mm x D = 695 mm x H = 800 mm</p>		03-4G
<p>Rollboy</p> <p>As described above</p> <p>2 drawers 75 mm</p> <p>1 drawer 150 mm</p> <p>1 drawer 200 mm</p> <p>W = 605 mm x D = 695 mm x H = 750 mm</p>		03-4K
<p>Rollboy</p> <p>As described above</p> <p>2 drawers 100 mm</p> <p>2 drawers 150 mm</p> <p>1 drawer 200 mm</p> <p>W = 605 mm x D = 695 mm x H = 950 mm</p>		03-4L

Workbench Accessories

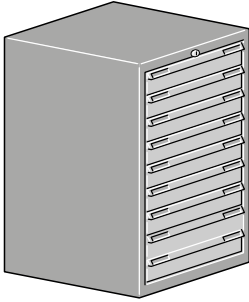

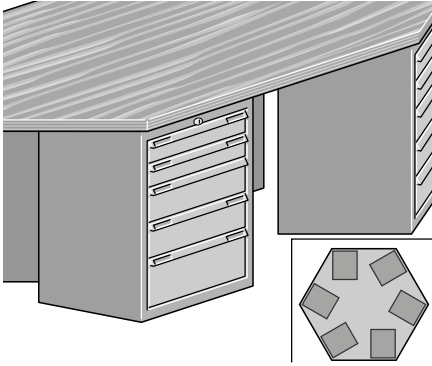

Technical data

Description		Order-No.
<p>Steel Cabinet as side cabinet</p> <p>Design as for workbench base cabinets, but with individual drawer lock.</p> <p>9 drawers 100 mm</p> <p>Drawer inner dimensions: W = 700 mm D = 600 mm</p> <p>W = 805 mm x D = 695 mm x H = 1000 mm</p>		03-5A
<p>Steel Cabinet as side cabinet</p> <p>Design as for workbench base cabinets, but with individual drawer lock.</p> <p>5 drawers 100 mm 2 drawers 200 mm</p> <p>Drawer inner dimensions: W = 700 mm D = 600 mm</p> <p>W = 805 mm x D = 695 mm x H = 1000 mm</p>		03-5B
<p>Hexagonal workbench</p> <p>Tabletop made of a multi-layer, glued multiplex beech wood plate; bevelled edges ground on all sides. Surface treated with linseed oil. Material thickness 40 mm.</p> <p>6 blocks of drawers are installed underneath 2 drawers 100 mm 2 drawers 150 mm 1 drawer 200 mm</p> <p>W = 2491 mm x D = 2164 mm x H = 840 mm</p>		03-6A

Workbench Accessories

The drawers for the workbench base cabinets and rollboys can be organized throughout by means of the surrounding perforations. Drawer interior dimensions: W = 500 mm, D = 600 mm. The division elements are available for the drawer heights 75 mm / 100 mm / 150 mm and 200 mm.

Technical data

Description		Order-No.
<p>Foam rubber</p> <p>Insert for all drawer heights, suitable</p> <p>W = 500 mm D = 600 mm</p>		03-4P
<p>Tray inserts</p> <p>for drawer height 75 mm</p> <ul style="list-style-type: none"> 8 tray inserts 2-part, 73 mm 4 tray inserts 2-part, 48 mm 4 tray inserts 4-part, 36 mm 8 tray inserts 2-part, 73 mm 16 tray inserts 3-part, 48 mm 16 tray inserts 4-part, 36 mm 		03-4Q
<p>Insert boxes made of plastic</p> <p>for drawer height 75 mm</p> <ul style="list-style-type: none"> 6 insert boxes W = 100 mm D = 100 mm H = 55 mm 12 insert boxes W = 100 mm D = 200 mm H = 55 mm <p>for drawer height 100 mm</p> <ul style="list-style-type: none"> 6 insert boxes W = 100 mm D = 100 mm H = 88 mm 12 insert boxes W = 100 mm D = 200 mm H = 88 mm 		<p>03-4R</p> <p>03-4S</p>
<p>Longitudinal/transverse partitions</p> <p>Made of zinc-coated steel plate</p> <p>for drawer height 100 mm</p> <ul style="list-style-type: none"> 4 longitudinal partitions 10 transverse partitions 100 mm 		03-4T

Workbench Accessories

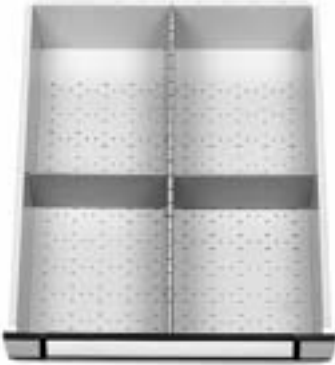

Technical data

Description		Order-No.
<p>Longitudinal/transverse partitions Made of zinc-coated steel plate</p> <p>for drawer height 150 mm 4 longitudinal partitions 10 transverse partitions 100/150</p>		03-4U
<p>Longitudinal/transverse partitions Made of zinc-coated steel plate</p> <p>for drawer height 200 mm 1 longitudinal partition 2 transverse partitions 200/250</p>		03-4V

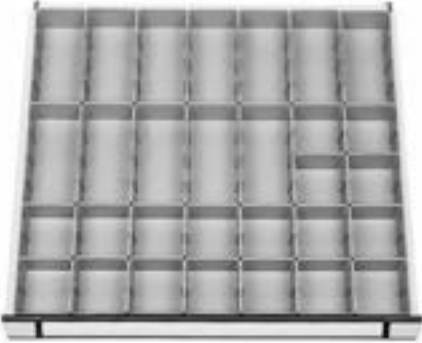

Workbench Accessories

Technical data

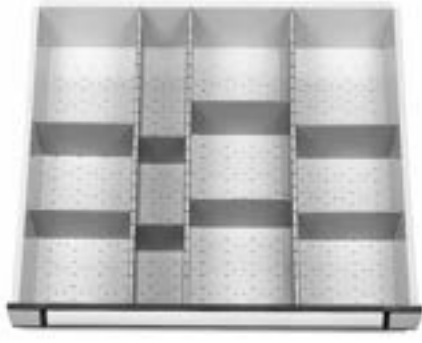
Description		Order-No.
<p>Inserts</p> <p>Suitable for all drawer heights</p> <p>W = 700 mm x D = 600 mm x H = 4 mm</p>		03-5P
<p>Insert Boxes made of plastic</p> <p>for drawer height 100 mm</p> <p>18 insert boxes W = 100 mm D = 100 mm H = 88 mm</p> <p>12 insert boxes W = 100 mm D = 200 mm H = 88 mm</p>		03-5S
<p>Longitudinal/transverse partitions Made of zinc-coated steel plate</p> <p>for drawer height 100 mm</p> <p>3 longitudinal partitions</p> <p>2 transverse partitions 100/100</p> <p>6 transverse partitions 100/200</p>		03-5T
<p>Longitudinal/transverse partitions Made of zinc-coated steel plate</p> <p>for drawer height 200 mm</p> <p>3 longitudinal partitions</p> <p>2 transverse partitions 100/200</p> <p>6 transverse partitions 200/200</p>		03-5V

Storage shelf

The Elabo steel shelves can be extended as individual elements or in connection with the mounted parts into complete storage systems. The side support frames with insertable horizontal crossbars are made of a sturdy steel U profile. The shelves and drawers can be inserted into the 25 mm grid. In the same way, the shelves can be panelled with the side or rear wall elements. We can also provide a plinth for the front. All steel elements are powder coated in light grey (RAL 7035).

Technical data

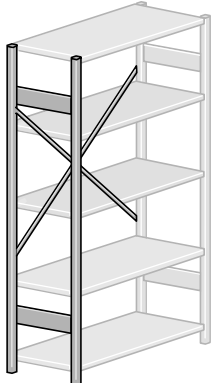
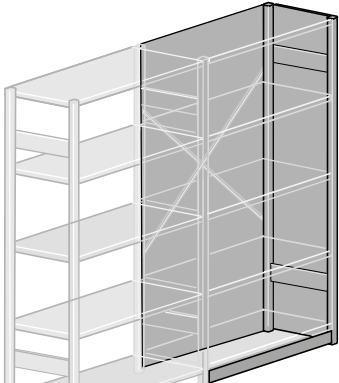
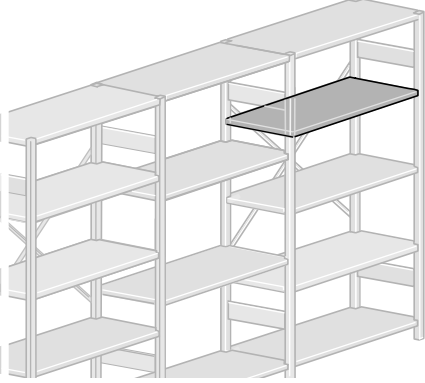
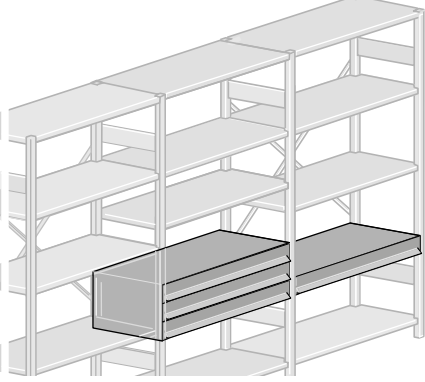

Description		Order-No.
<p>Shelf support Brace</p> <p>Steel shelf support with equaliser bars</p> <p>Diagonal brace 1 x required for basic shelf unit and 1 x for each attached shelf unit</p> <p>Standard shelf dimensions: 1064 mm x 500 mm x 2000 mm Attached shelf unit dimensions: 1032 mm x 500 mm x 2000 mm</p> <p>W = 32 mm x D = 500 mm x H = 2000 mm</p>		<p>03-7C X01</p> <p>03-7D X01</p>
<p>Side and rear wall plinth Made of zinc-coated steel plate</p> <p>Shelf side wall with integrated steel shelf support, type 03-7C W = 32 mm x D = 500 mm x H = 2000 mm</p> <p>Shelf rear wall W = 1000 mm x D = 1,5 mm x H = 2000 mm</p> <p>Steel plate plinth as front panelling W = 1000 mm x D = 1,5 mm x H = 50 mm</p>		<p>03-7E X01</p> <p>03-7F X01</p> <p>03-7G X01</p>
<p>Steel plate shelf</p> <p>adjustable in 25 mm grid, capacity 115 kg, Field load max. 1300 kg, powder coated W = 1000 mm x D = 500 mm H = 29 mm</p> <p>As above but zinc-coated W = 1000 mm x D = 500 mm x H = 29 mm</p>		<p>03-7H X01</p> <p>03-7J X01</p>
<p>Steel plate drawers</p> <p>Steel plate individual drawer with ball bearing guides, load capacity 100 kg</p> <p>W = 1000 mm x D = 500 mm x H = 100 mm</p>		<p>03-7K</p>

Storage shelf

Steel cabinets supplement the shelf systems in the storage logistics. Material, measuring equipment and tools can thus be stored dust-free in a locked environment.

The mobile shelf trolleys are ideal for swift transport of materials to incoming goods, warehouses or production.

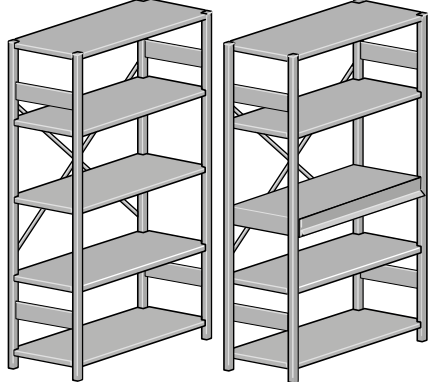
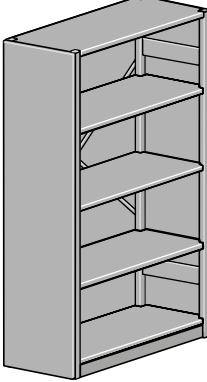
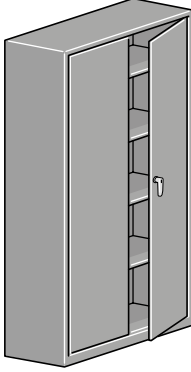
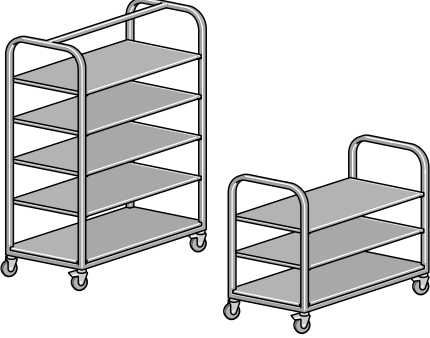
Technical data

Description		Order-No.
<p>Steel shelf units</p> <ul style="list-style-type: none"> 2 steel shelf supports 1 diagonal brace 5 coated shelves <ul style="list-style-type: none"> 2 steel shelf supports with crossbars 1 diagonal brace 1 steel plate individual drawer 4 coated shelves <p>W = 1064 mm x D = 500 mm x H = 2000 mm</p>		<p>03-7Q X01</p> <p>03-7S X01</p>
<p>Steel shelf units with side walls</p> <ul style="list-style-type: none"> 2 shelf side walls inc. steel shelf supports 1 rear wall 1 plinth 5 coated shelves <p>W = 1064 mm x D = 500 mm x H = 2000 mm</p>		<p>03-7R X01</p>
<p>Steel cabinet</p> <p>Double-wing door steel cabinet made of 1.25 mm thick steel sheeting, RAL 7035 powder coated, 4 height-adjustable galvanized shelves, 25 mm hook-on grid, load-bearing capacity 100 kg, twist handle with security lock</p> <p>W = 1000 mm x D = 400 mm x H = 1950 mm</p>		<p>03-7A X1</p>
<p>Shelf trolleys</p> <p>made of bent steel pipe 30 mm x 30 mm x 2 mm, lower frame 40 mm x 20 mm x 2 mm with welded-in cross-sheets, four rubber casters, 125 mm in diameter, light grey, powder coated</p> <p>with 1 bottom plate and 4 removable shelves made of 19 mm flat laminate, melamine resin-coated with 2 mm PP edge strip ESD design</p> <p>W = 1110 mm x D = 645 mm x H = 1660 mm</p> <p>Design as above, but with 2 removable shelves ESD design</p> <p>W = 1110 mm x D = 645 mm x H = 1010 mm</p>		<p>03-8A</p> <p>01-5X</p>  <p>03-8B</p> <p>01-5Y</p> 

Working environments for people with ideas.



7620BKE/23-04 Subject to technical changes without notice.



www.elabo.com



www.elabo-shop.de/en

ELABO GmbH –
a company of the
Bott group
Roßfelder Straße 56
74564 Crailsheim
Deutschland
Fon +49 7951 307-0
Fax +49 7951 307-66
info@elabo.de
www.elabo.de